

KAWAI

ES110 Owner's Manual

Preparation Before Use

Playing the Piano

Internal Songs

Recorder

Settings

Appendix

EN

Thank you for purchasing this Kawai ES110 digital piano.

This owner's manual contains important information regarding the instrument's usage and operation.

Please read all sections carefully, keeping this manual handy for future reference.

Important Safety Instructions

SAVE THESE INSTRUCTIONS

INSTRUCTIONS PERTAINING TO A RISK OF FIRE, ELECTRIC SHOCK, OR INJURY TO PERSONS



AVIS : RISQUE DE CHOC ELECTRIQUE - NE PAS OUVRIR.

TO REDUCE THE RISK OF ELECTRIC SHOCK, DO NOT REMOVE COVER (OR BACK).
NO USER-SERVICEABLE PARTS INSIDE. REFER SERVICING TO QUALIFIED SERVICE PERSONNEL.



The lightning flash with arrowhead symbol, within an equilateral triangle, is intended to alert the user to the presence of uninsulated "dangerous voltage" within the product's enclosure that may be of sufficient magnitude to constitute a risk of electric shock to persons.



The exclamation point within an equilateral triangle is intended to alert the user to the presence of important operating and maintenance (servicing) instructions in the literature accompanying the product.

Examples of Picture Symbols



denotes that care should be taken.
The example instructs the user to take care not to allow fingers to be trapped.



denotes a prohibited operation.
The example instructs that disassembly of the product is prohibited.



denotes an operation that should be carried out.
The example instructs the user to remove the power cord plug from the AC outlet.

Read all the instructions before using the product.

- 1) Read these instructions.
- 2) Keep these instructions.
- 3) Heed all warnings.
- 4) Follow all instructions.
- 5) Do not use this apparatus near water.
- 6) Clean only with dry cloth.
- 7) Do not block any ventilation openings. Install in accordance with the manufacturer's instructions.
- 8) Do not install near any heat sources such as radiators, heat registers, stoves, or other apparatus (including amplifiers) that produce heat.
- 9) Do not defeat the safety purpose of the polarized or grounding-type plug. A polarized plug has two blades with one wider than the other. A grounding type plug has two blades and a third grounding prong. The wide blade or the third prongs are provided for your safety. If the provided plug does not fit into your outlet, consult an electrician for replacement of the obsolete outlet.
- 10) Protect the power cord from being walked on or pinched particularly at plugs, convenience receptacles, and the point where they exit from the apparatus.
- 11) Only use attachments/accessories specified by the manufacturer.
- 12) Use only with the cart, stand, tripod, bracket, or table specified by the manufacturer, or sold with the apparatus. When a cart is used, use caution when moving the cart/apparatus combination to avoid injury from tip-over. 
- 13) Unplug this apparatus during lightning storms or when unused for long periods of time.
- 14) Refer all servicing to qualified service personnel. Servicing is required when the apparatus has been damaged in any way, such as power-supply cord or plug is damaged, liquid has been spilled or object have fallen into the apparatus, the apparatus has been exposed to rain or moisture, does not operate normally, or has been dropped.

WARNING - When using electric products, basic precautions should always be followed, including the following.



WARNING

Indicates a potential hazard that could result in death or serious injury if the product is handled incorrectly.

The product should be connected to an AC outlet of the specified voltage.



- If you are going to use an AC power cord, make sure that its has the correct plug shape and conforms to the specified power voltage.
- Failure to do so may result in fire.

Do not insert or disconnect the power cord plug with wet hands.



Doing so may cause electric shock.

Take care not to allow any foreign matter to enter the product.

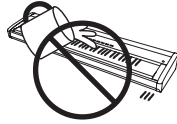

Entry of water, needles or hair pins may result in breakdown or short-circuit. The product shall not be exposed to dripping or splashing. No objects filled with liquids, such as vases, shall be placed on the product.

The chair must be used properly (it must be used only when playing the product).

- Do not play with it or stand on it.
- Only one person is allowed to sit on it.
- Do not sit on it when opening the lid.
- Re-tighten the bolts occasionally.

Doing so may cause the chair to fall over or your fingers to be trapped, resulting in injury.

When using the headphones, do not listen for long periods of time at high volume levels.

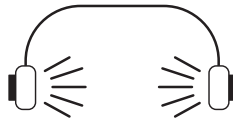

Doing so may result in hearing problems.

Do not lean against the keyboard.

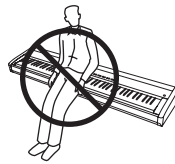

Doing so may cause the product to fall over, resulting in injury.

Do not disassemble, repair or modify the product.

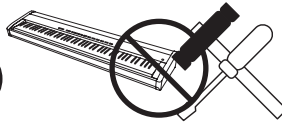

Doing so may result in product breakdown, electric shock or short-circuit.

When disconnecting the AC power cord's plug, always hold the plug and pull it to remove it.



- Pulling the AC power cord itself may damage the cord, causing a fire, electric shock or short-circuit.

The product is not completely disconnected from the power supply even when the power switch is turned off. If the product will not be used for a long time, unplug the AC power cord from the AC outlet.



- Failure to do so may cause fire in case of lightning.
- Failure to do so may over-heat the product, resulting in fire.

This product may be equipped with a polarized line plug (one blade wider than the other). This is a safety feature. If you are unable to insert the plug into the outlet, contact an electrician to replace your obsolete outlet. Do not defeat the safety purpose of the plug.

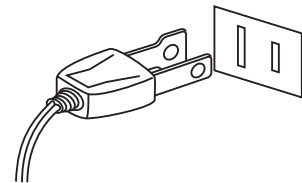

It is a good practice to have the instrument near the AC outlet and the power cord plug in a position so that it can readily be disconnected in an emergency because electricity is always charging while the plug is in the AC outlet even in a power switch off condition.



CAUTION

Indicates a potential hazard that could result in injury or damage to the product or other property if the product is handled incorrectly.

Do not use the product in the following areas.

- Areas, such as those near windows, where the product is exposed to direct sunlight
- Extremely hot areas, such as near a heater
- Extremely cold areas, such as outside
- Extremely humid areas
- Areas where a large amount of sand or dust is present
- Areas where the product is exposed to excessive vibrations

Using the product in such areas may result in product breakdown. Use the product only in moderate climates (not in tropical climates).

Use only the AC adaptor included with this instrument to power the instrument.

- Do not use other AC adaptors to power this instrument.
- Do not use the included AC adaptor or AC power cord to power other equipment.

Before connecting cords, make sure that the power to this product and other devices is turned OFF.



Failure to do so may cause breakdown of this product and other devices.

Do not drag the product on the floor. Take care not to drop the product.

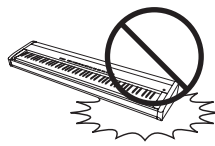

Please lift up the product when moving it. Please note that the product is heavy and must be carried by more than two persons. Dropping the product may result in breakdown.

Do not place the product near electrical appliances such as TVs and radios.

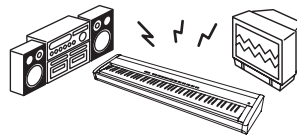

- Doing so may cause the product to generate noise.
- If the product generates noise, move the product sufficiently away from the electrical appliance or connect it to another AC outlet.

When connecting the AC power cord and other cords, take care not to get them tangled.



Failure to do so may damage them, resulting in fire, electric shock or short-circuit.

Do not wipe the product with benzene or thinner.



- Doing so may result in discoloration or deformation of the product.
- When cleaning the product, put a soft cloth in lukewarm water, squeeze it well, then wipe the product.

Do not stand on the product or exert excessive force.



- Doing so may cause the product to become deformed or fall over, resulting in breakdown or injury.

Do not place naked flame, such as lighted candles on the product.



Doing so may cause the illumination to fall over, resulting in fire.

Ensure that the ventilation is not impeded by covering the ventilation openings with items, such as newspaper, table-cloths, curtains, etc.



Failure to do so may over-heat the product, resulting in fire.

The product should be located so that its location or position does not interfere with its proper ventilation. Ensure a minimum distance of 5cm around the product for sufficient ventilation.

The product should be serviced by qualified service personnel when:

- The power supply cord or the plug has been damaged.
- Objects have fallen, or liquid has been spilled into the product.
- The product has been exposed to rain.
- The product does not appear to operate normally or exhibits a marked change in performance.
- The product has been dropped, or the enclosure damaged.

Notes on Repair

Should an abnormality occur in the product, immediately turn the power OFF, disconnect the power cord plug, and then contact the shop from which the product was purchased.

CAUTION:

To prevent electric shock, match wide blade of plug to wide slot, fully insert.

ATTENTION:

Pour éviter les chocs électriques, introduire la lame la plus large de la fiche dans la borne correspondante de la prise et pousser jusqu'au fond.

An information on Disposal for users



If your product is marked with this recycling symbol it means that, at the end of its life, you must dispose of it separately by taking it to an appropriate collection point.

You should not mix it with general household waste. Disposing of this product correctly will prevent potential negative effects on the environment and human health which could otherwise arise due to inappropriate waste handling.

For further details, please contact your local authority.
(European Union only)

Instruction for AC power cord (U.K.)

IMPORTANT

THE WIRES IN THIS MAINS LEAD ARE COLOURED IN ACCORDANCE WITH THE FOLLOWING CODE.

BLUE : NEUTRAL
BROWN : LIVE

As the colours of the wires in the mains lead of this apparatus may not correspond with the coloured markings identifying the terminals in your plug, proceed as follows:

The wire which is coloured BLUE must be connected to the terminal which is marked with the letter N or coloured BLACK.

The wire which is coloured BROWN must be connected to the terminal which is marked with the letter L or coloured RED.

Do not plug either terminal of the power cord to the the ground od AC outlet on the wall.

FCC Information (U.S.A)

CAUTION : Changes or modifications not expressly approved by the party responsible for compliance could void the user's authority to operate the equipment.

NOTE : This equipment has been tested and found to comply with the limits for a Class B digital device, pursuant to Part 15 of the FCC Rules. These limits are designed to provide reasonable protection against harmful interference in a residential installation. This equipment generates, uses and can radiate radio frequency energy and, if not installed and used in accordance with the instructions, may cause harmful interference to radio communications. However, there is no guarantee that interference will not occur in a particular installation. If this equipment does cause harmful interference to radio or television reception, which can be determined by turning the equipment off and on, the user is encouraged to try to correct the interference by one or more of the following measures:

- Reorient or relocate the receiving antenna.
- Increase the separation between the equipment and receiver.
- Connect the equipment into an outlet on a circuit different from that to which the receiver is connected.
- Consult the dealer or an experienced radio/TV technician for help.

Declaration of Conformity

Products :	Electronic Piano
Model Number :	ES110
Responsible Party Name :	Kawai America Corporation
Address :	2055 East University Drive Rancho Dominguez, CA 90220
Telephone	310-631-1771

This device complies with Part 15 of the FCC Rules.

Operation is subject to the following two conditions:

- (1) this device may not cause harmful interference, and
- (2) this device must accept any interference received, including interference that may cause undesired operation.

This applies only to products distributed by Kawai America Corporation.

The nameplate label is located on the underside of the instrument, as indicated below.

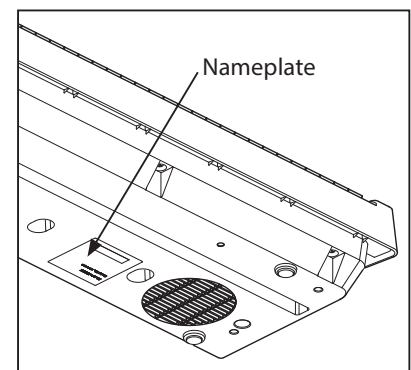

About Bluetooth

- The Bluetooth® word mark and logos are registered trademarks owned by the Bluetooth SIG, Inc. and any use of such marks by Kawai Musical Instruments Mfg. Co., Ltd. is under license. Other trademarks and trade names are those of their respective owners.
- Frequency Band of Radio: 2400~2483.5 MHz Maximum Transmit Power: 2.5 mW
- Availability of Bluetooth function dependent on market location.



Table of Contents

Important Safety Instructions.....	4	6. Transpose.....	32
Table of Contents	8	7. Brilliance	33
Preface	9	8. Touch.....	34
Preparation Before Use		9. Tuning	35
Part Names and Functions	10	10. Temperament.....	36
Setting Up the Piano	11	11. Temperament Key.....	37
Basic Operation	12	12. Effect On/Off.....	38
Playing the Piano		MIDI Settings	39
Selecting Sounds	13	1. Transmit MIDI Program Change	41
Dual Mode.....	15	2. MIDI Channel (transmit/receive)	42
Split Mode.....	16	3. Local Control.....	43
Metronome / Drum Rhythms	17	4. Multi-timbral Mode	44
Registration Memories	19	Speaker Settings	45
Internal Songs		1. Speaker EQ.....	45
Demo Songs	20	2. Speakers On/Off.....	46
Lesson Function	21	Other Settings	47
1. Selecting a lesson book/song.....	21	1. Auto Power Off.....	47
2. Listening to the selected lesson song	22	2. Bluetooth® MIDI.....	48
3. Practicing left and right-hand parts separately...	23	Memory Functions	49
Recorder		1. Startup Setting	49
Recorder	24	2. Factory Reset.....	49
1. Recording a song.....	24	Appendix	
2. Playing back a song	25	Connecting to Other Devices	50
3. Erasing recorded songs.....	25	Rear Connectors.....	51
Settings		Front Connectors.....	51
Keyboard and Sound Settings	26	Troubleshooting	52
1. Reverb	27	Settings List	53
2. Damper Resonance.....	28	Demo Song Lists	54
3. Voicing.....	29	Drum Rhythm List.....	55
4. Fall-back Noise	30	Lesson Function Song Lists	56
5. Damper Noise.....	31	Specifications	58
		MIDI Implementation Chart.....	59
		Operation Guide	61

■ About this Owner's Manual

Before attempting to play this instrument, please read the **Preparation Before Use** section from page 10 of this owner's manual. This section explains the name and function of each part, how to connect the power cable, and how to turn on the power.

The **Playing the Piano** section (page 13) provides an overview of the instrument's most commonly used functions, allowing the ES110 digital piano to be enjoyed almost immediately after being connected, while the **Internal Songs** section (page 20) includes information regarding the built-in demonstration songs, and Lesson function.

The **Recorder** section (page 24) provides instructions on how to record and play back pieces stored in the instrument's internal memory, and the **Settings** section (page 26) details the settings that can be used to adjust a number of sound and keyboard characteristics, as well as basic MIDI functionality.

Finally, the **Appendix** section (page 50) includes listings for all demo, and Lesson function songs, a troubleshooting guide, MIDI reference information, and full specification details.

■ ES110 Feature Highlights

Responsive Hammer Compact (RHC) weighted-key keyboard action

The new *Responsive Hammer Compact* (RHC) action has been developed to reproduce the distinctive touch of an acoustic grand piano. The weight of the keyboard is appropriately graded to mirror the heavier bass and lighter treble hammers of acoustic pianos, with a smooth matte texture applied to each black and white key for enhanced playability. As with all Kawai digital piano keyboard actions, *Responsive Hammer Compact* utilises hammer velocity sensors, and features a springless mechanism that delivers a smooth and natural piano playing experience.

Despite its lightweight, compact design, the RHC action allows experienced pianists to perform with confidence, playing fortissimo with power and certainty, while delicately controlling the softest, most gentle pianissimo passages.

Harmonic Imaging™ (HI) sound technology, 88-key piano sampling

The ES110 digital piano captures the beautiful sound of Kawai's highly acclaimed hand-built concert grand piano, with all 88 keys of this exceptional instrument meticulously recorded, analysed and faithfully reproduced using proprietary *Harmonic Imaging*™ technology. This unique process accurately recreates the broad dynamic range of the original grand piano, affording pianists an extraordinary level of expressiveness ranging from the softest pianissimo to the strongest, boldest fortissimo.

Additional reverberation effects that simulate the acoustic environment of a recital room, small room, or concert hall are also applied, resulting in a rich, vibrant piano tone that delivers breathtaking realism and authenticity.

Internal Song recorder, Built-in Lesson Function

The ES110 digital piano features a three song recorder, allowing performances to be recorded to internal memory and played back at the touch of a button. In addition, the convenient lesson feature allows aspiring pianists to learn the piano using a built-in collection of etudes from Burgmüller and songs from the popular *Alfred* course books. The left and right hand parts for each piece can be practiced separately, while adjusting the tempo allows more difficult passages to be perfected.

Integrated Bluetooth® MIDI connectivity

In addition to standard MIDI jacks for connecting to other instruments, the ES110 digital piano also boasts integrated *Bluetooth* MIDI technology that allows the instrument to communicate with supported smart devices wirelessly. Once connected to a phone, tablet, or laptop, ES110 digital piano owners can enjoy a wide variety of exciting music-related apps that enhance their learning and playing experience without additional cables.

* Availability of Bluetooth function dependent on market location.

Part Names and Functions

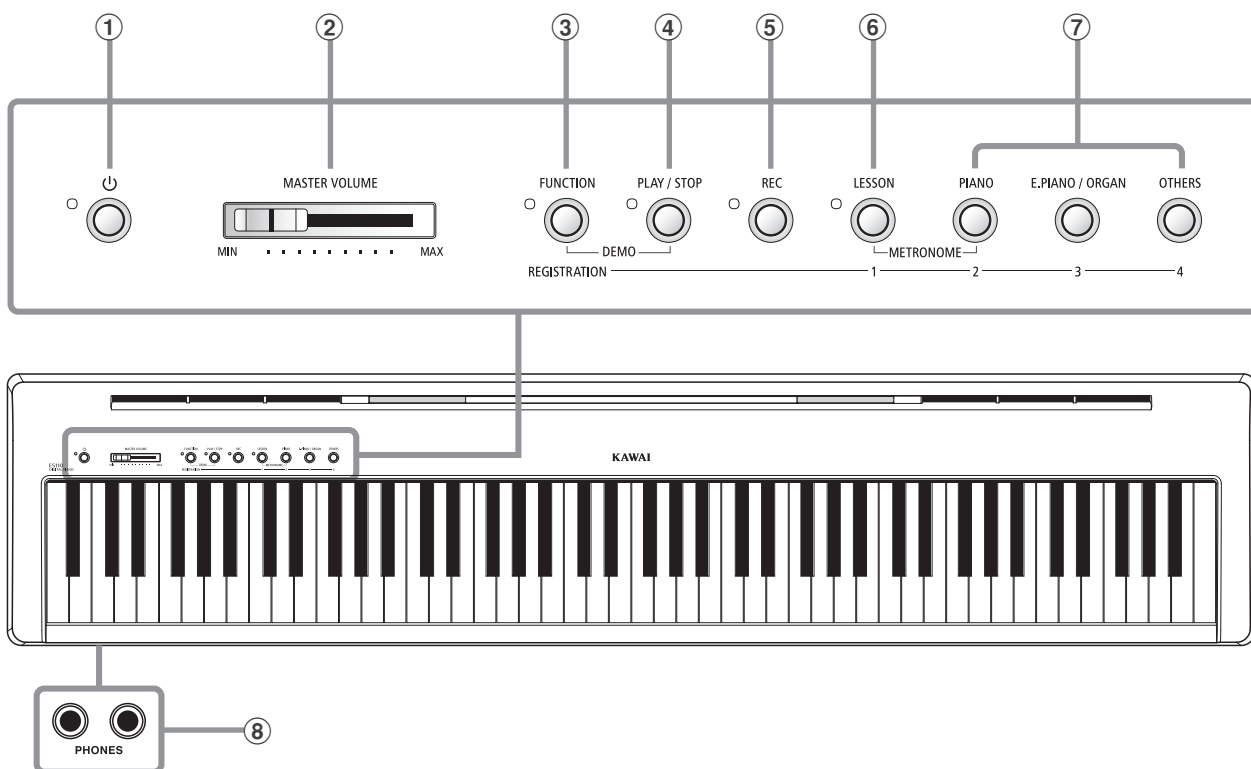

① POWER button

This button is used to turn the instrument on/off.

* The ES110 digital piano features a power saving mode that can turn off the instrument automatically after a specified period of inactivity. For more information, please refer to the Auto Power Off setting on page 47.

② MASTER VOLUME slider

This slider controls the master volume level of the instrument's built-in speakers or headphones, if connected. This slider will also adjust the LINE OUT level.

③ FUNCTION button

This button allows various settings of the ES110 digital piano to be adjusted.

④ PLAY / STOP button

This button is used to start/stop the playback of Recorder songs stored in memory and the ES110 digital piano's built-in Lessons songs.

⑤ REC button

This button is used to record performances to the ES110 digital piano's internal memory.

⑥ LESSON button

This button is used to select the ES110 digital piano's built-in Lesson songs.

⑦ SOUND buttons

These buttons are used to select the sound(s) that will be heard when playing the instrument's keyboard. These buttons are also used to select Registration memories.

⑧ PHONES jacks

These jacks are used to connect stereo headphones to the ES110 digital piano. Two pairs of headphones can be connected and used simultaneously.

* For more information about connectors/jacks, please refer to page 51.

■ Operation Guide

The separate Operation Guide provides a convenient overview of the ES110 digital piano's various button and keyboard controls. This sheet is also reprinted in the Appendix section of this owner's manual.

Setting Up the Piano

Upon unboxing the instrument, please follow the instructions below which explain how to attach the music rest, connect the F-10H foot pedal, and if desired, connect a pair of headphones.

■ Attaching the music rest

Insert the legs of the music rest into the holes located at the rear of the ES110 digital piano, taking care not to scratch the rear of the instrument.

To prevent possible damage, avoid applying excessive force when attaching/detaching the music rest from the instrument.

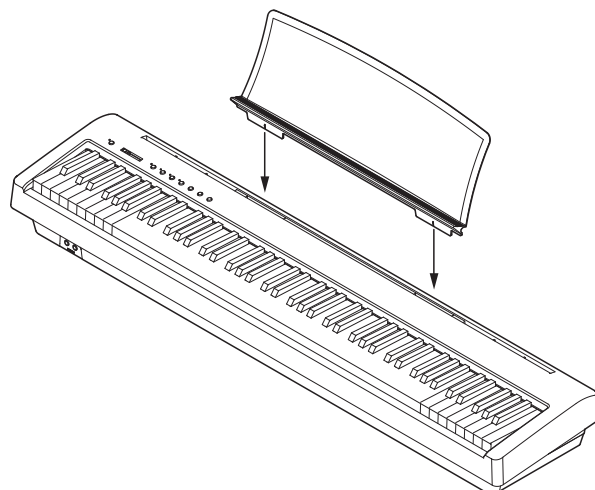

■ Connecting the F-10H foot pedal

Connect the included Kawai F-10H foot pedal to the DAMPER pedal jack located on the rear panel of the instrument.

The foot pedal will function as a damper pedal, sustaining the sound after hands are lifted from the keyboard. This pedal is capable of responding to 'half pedaling'.

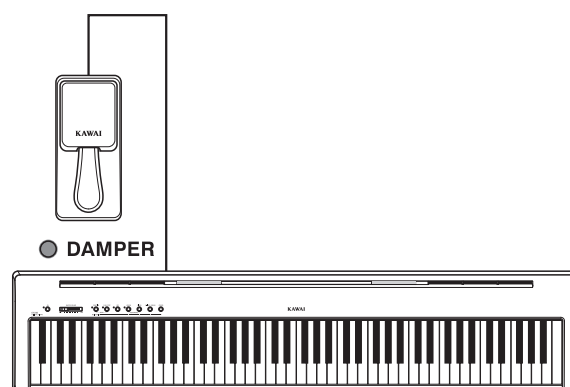

■ Connecting headphones

Use the Phones jacks located on the left side of the keyboard to connect stereo headphones to the ES110 digital piano.

Two pairs of headphones can be connected and used simultaneously. When a pair of headphones is connected, sound will not be produced by the built-in speakers.

* The built-in speakers can also be disabled by using the Speakers On/Off setting. For more information, please refer to page 46.

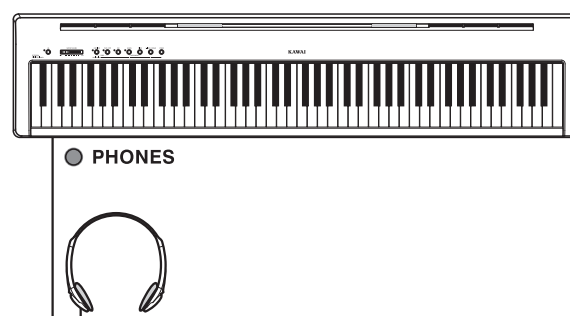

Basic Operation

The following instructions explain how to connect the instrument to the power outlet, turn on the power, adjust the volume to a comfortable level, and begin playing the piano.

1. Connecting the power adaptor

Connect the included AC power adaptor to the 'DC IN' jack located on the rear panel of the instrument, indicated below.

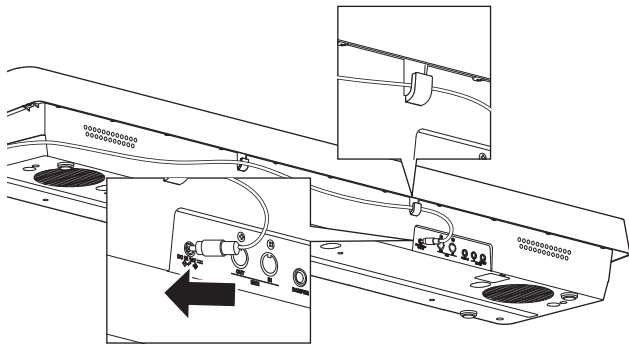

Connect the AC power adaptor to an AC outlet.

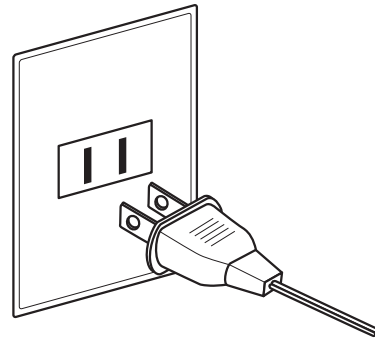

2. Turning on the instrument's power

Press the POWER button located on the left side of the instrument's control panel.

* The ES110 digital piano features a power saving mode that can turn off the instrument automatically after a specified period of inactivity. For more information, please refer to the Auto Power Off setting on page 47.



3. Adjusting the volume

The MASTER VOLUME slider controls the volume level of the instrument's speakers, or headphones if connected. This slider will also adjust the LINE OUT level.

Move the slider to the right to increase the volume, and to the left to decrease the volume.

Use this slider to set the volume to a comfortable listening level - the middle is often a good starting point.

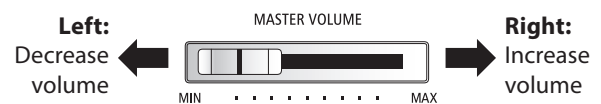

4. Play the piano

Begin playing the piano.

The rich sound of a Kawai EX Concert Grand Piano will be heard as the keys are pressed.

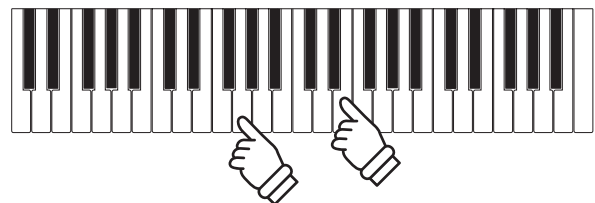

Selecting Sounds

The ES110 digital piano features 19 different instrument sounds, which can be selected in one of two ways. By default the 'Concert Grand' sound will be selected automatically when the instrument is turned on.

Instrument Sounds

PIANO		E.PIANO / ORGAN		OTHERS	
1	Concert Grand	1	Classic E.Piano	1	Slow Strings
2	Concert Grand 2	2	60's E.Piano	2	String Ensemble
3	Studio Grand	3	Modern E.Piano	3	Wood Bass
4	Studio Grand 2	4	Jazz Organ	4	Electric Bass
5	Mellow Grand	5	Church Organ	5	Harpsichord
6	Mellow Grand 2			6	Vibraphone
7	Modern Piano				
8	Rock Piano				

* When the Jazz Organ sound is selected, the fast/slow speed of the applied Rotary effect can be changed by pressing the FUNCTION and REC buttons simultaneously.

1. Selecting a sound category

Press the desired SOUND button.



Example: To select the E.PIANO category, press the E.PIANO button.

2. Selecting a sound

The ES110 digital piano allows two methods of selecting sounds.

Selecting a sound: Method 1

Press a SOUND button repeatedly to cycle through the instrument sounds.



Selecting Sounds

■ Selecting a sound: Method 2

Press and hold a SOUND button, then press one of the lowest white keys to select the desired instrument sound.

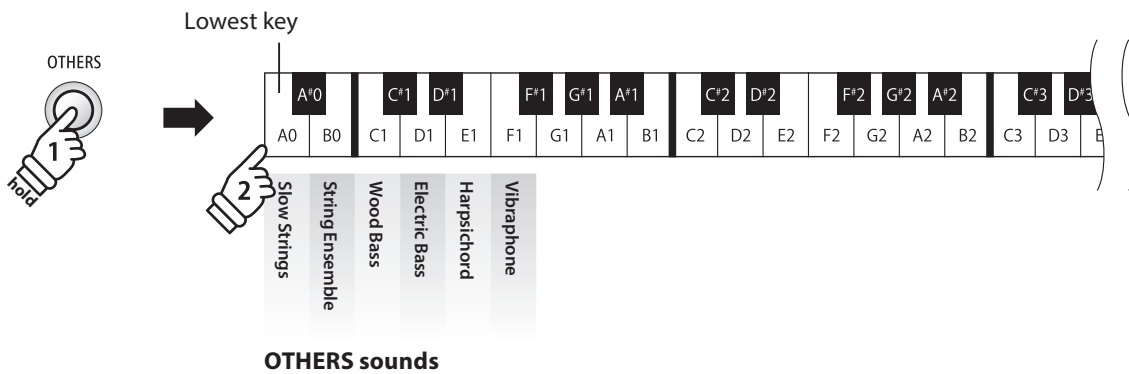
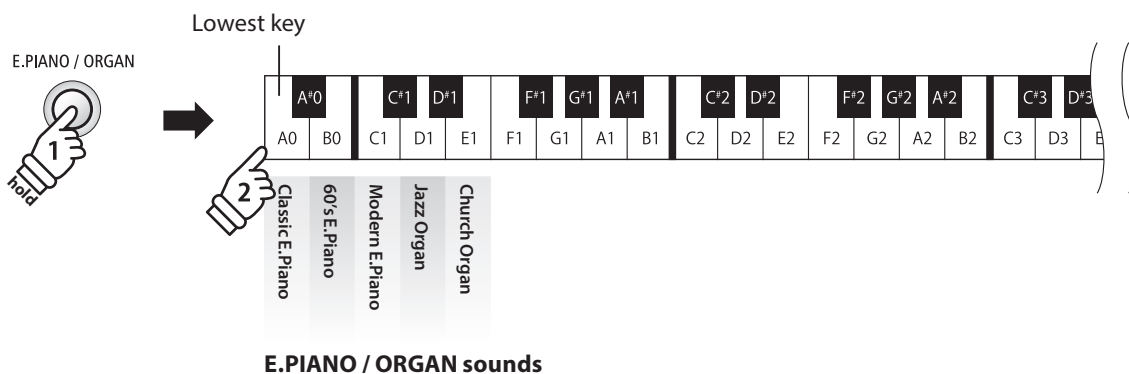
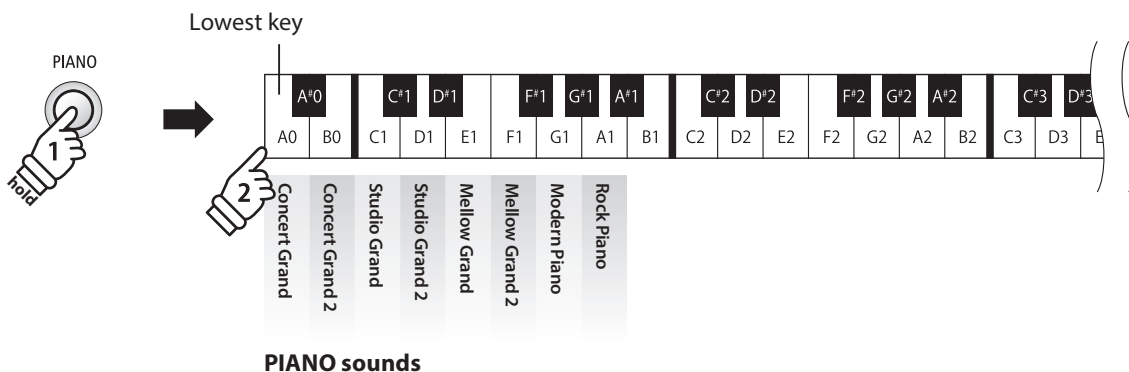

Dual Mode

The Dual Mode function allows two sounds to be layered together, creating a more complex sound. For example, a piano sound layered with strings, or an electric piano combined with a harpsichord, etc.

1. Entering Dual mode

Press and hold a SOUND button to select the main sound, then press another SOUND button to select the layered sound.

* Preferred Dual mode sound combinations can be stored to a Registration memory for convenient recall. Please refer to page 19 for more information.

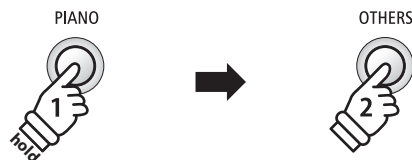

Example: To layer the 'Slow Strings' sound with the 'Concert Grand' sound, press and hold the PIANO button, then press the OTHERS button.

2. Changing the main/layered sounds

To select a different variation for the layered sound:

Press and hold the main SOUND button, then press the layered SOUND button repeatedly to cycle through the different sound variations.

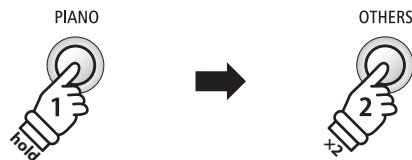

Example: To change the layered 'Slow Strings' sound to the 'String Ensemble' sound, press and hold the PIANO button, then press the OTHERS button twice.

To layer two variations assigned to the same SOUND button:

Press and hold a SOUND button, then press the A#0 key to enter Dual mode, then press two white keys to select the desired instrument sounds.

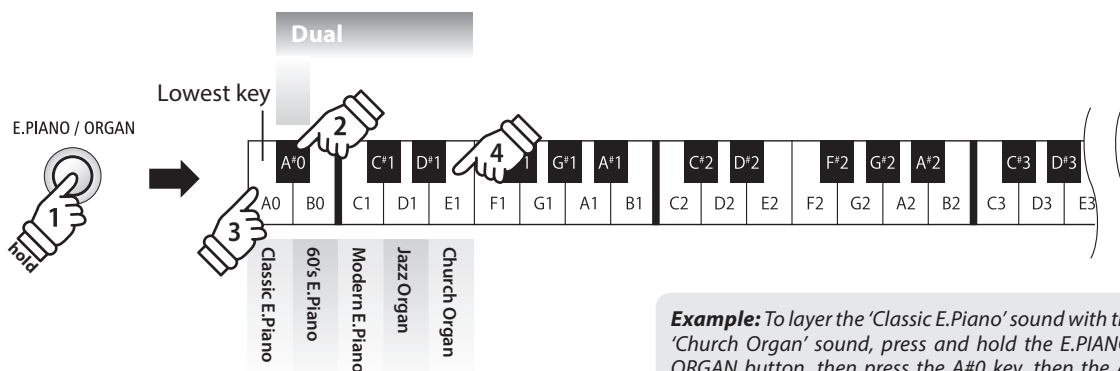

Example: To layer the 'Classic E.Piano' sound with the 'Church Organ' sound, press and hold the E.PIANO/ORGAN button, then press the A#0 key, then the A0 and E1 keys.

Adjusting the volume balance

Press and hold a SOUND button, then press the F#1 or G#1 keys repeatedly to decrease or increase the volume balance between the two sounds.

Exiting Dual Mode

Press a SOUND button.

The previously selected sound will be re-selected automatically and the instrument will return to normal operation.

Split Mode

The Split Mode function divides the keyboard into two sections, allowing each section to be played with a different sound. For example, a bass sound in the lower section, and a piano sound in the upper section.

■ Selecting Split sounds

After selecting the main (upper section) sound:

Press and hold a SOUND button, then press the C#1 key to enter Split mode, then press a white key to select the desired lower section sound.

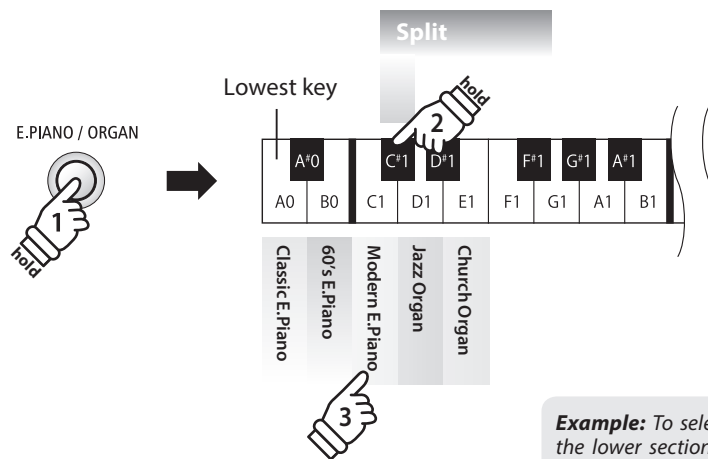

Example: To select the Modern E.Piano sound as the lower section split sound, press and hold the E.PIANO/ORGAN button, then press the C#1 key, followed by the C1 key.

* The split point is fixed between keys F#3 and G3.

* If a lower section sound is not specified, the 'Wood Bass' sound will be selected automatically.

* Preferred Split mode sound combinations can be stored to a Registration memory for convenient recall. Please refer to page 19 for more information.

■ Adjusting the volume balance

Press and hold a SOUND button, then press the F#1 or G#1 keys repeatedly to decrease or increase the volume balance between the two sounds.

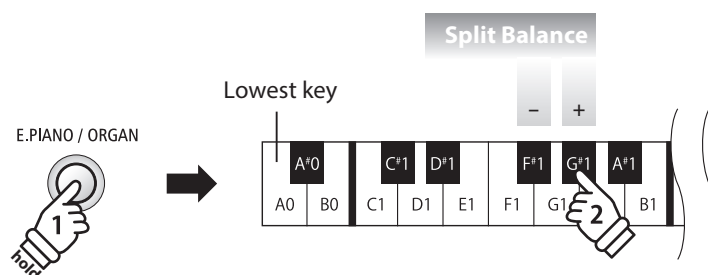

■ Exiting Split Mode

Press a SOUND button.

The previously selected sound will be re-selected automatically and the instrument will return to normal operation.

Metronome / Drum Rhythms

The Metronome function provides a steady beat to aid practicing the piano at a consistent tempo. The time signature, volume, and tempo of the metronome can be freely adjusted.

Turning the metronome on/off

Press and hold the LESSON button, then press the PIANO button.

The metronome will start to count.

* By default the metronome will count with a 4/4 beat at 120 bpm.

Press and hold the LESSON button, then press the PIANO button again to stop the metronome.

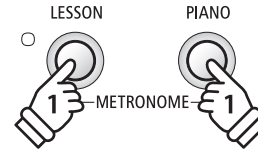

Changing the metronome time signature

Press and hold the LESSON and PIANO buttons, then press one of the 7 lowest black keys, as shown in the illustration below.

* The metronome can be set to one of seven time signatures: 1/4, 2/4, 3/4, 4/4, 5/4, 3/8, and 6/8.

Adjusting the metronome volume

Press and hold the LESSON and PIANO buttons, then press the keys marked 1~10 in the illustration below.

* The - / + keys can also be used to decrease or increase the metronome volume within the range of 1~10.

Lowest key

Time Signature																										
1/4		2/4		3/4		4/4		5/4		3/8		6/8														
A ⁰	B ⁰	C ¹	D ¹	E ¹	F ¹	G ¹	A ¹	B ¹	C ²	D ²	E ²	F ²	G ²	A ²	B ²	F ⁴										
A0	B0	C1	D1	E1	F1	G1	A1	B1	C2	D2	E2	F2	G2	A2	B2	C3	D3	E3	F3	G3	A3	B3	C4	D4	E4	F4
Tempo -		Tempo +															Volume -		Volume +							
		1 2 3 4 5 6 7 8 9 0															1 2 3 4 5 6 7 8 9 10									
Metronome Tempo (2 or 3 digits)																	Metronome Volume									

Metronome / Drum Rhythms

■ Adjusting the metronome tempo

Press and hold the LESSON and PIANO buttons, enter the desired tempo using the lowest 12 keys marked below.

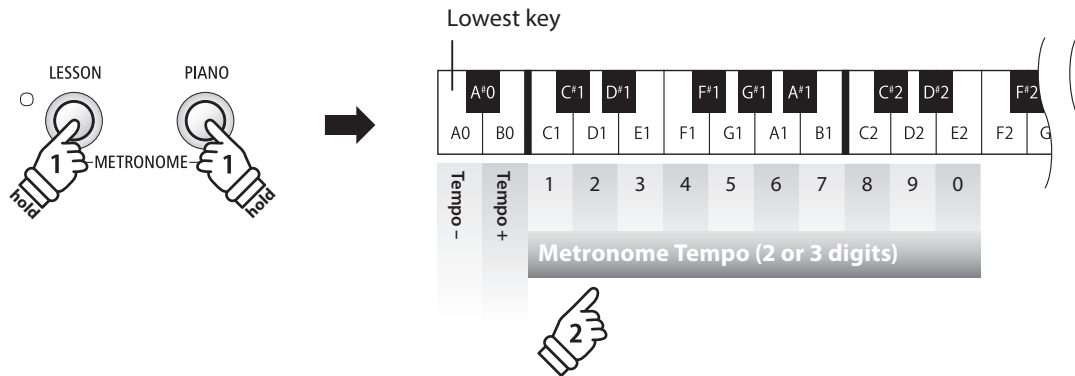

- * The metronome tempo can be adjusted within the range of 10~300 bpm.
- * The metronome tempo can be entered precisely, or decreased and increased gradually.

Method 1:

While pressing the LESSON and PIANO buttons, press keys 1, 5, and 0 to set the tempo to 150 bpm, or keys 8 and 5 to set the tempo to 85 bpm.

- * The tempo will change when the 3rd digit is entered, or when the LESSON and PIANO buttons are released.

Method 2:

While pressing the LESSON and PIANO buttons, press the - / + keys repeatedly to gradually decrease or increase the tempo in 2 bpm increments.

■ Drum rhythms

As an alternative to the simple metronome count, it is also possible to select a drum pattern from one of 100 different rhythm styles.

Method 1:

While pressing the LESSON and PIANO buttons, press keys 1, 5, to select rhythm no. 15.

- * The drum pattern will change when the 3rd digit is entered, or when the LESSON and PIANO buttons are released.

Method 2:

While pressing the LESSON and PIANO buttons, press the - / + keys to cycle through the available beats until reaching the '8 Beat 1' drum rhythm.

- * For a complete listing of available drum rhythms, please refer to page 55 of this owner's manual.

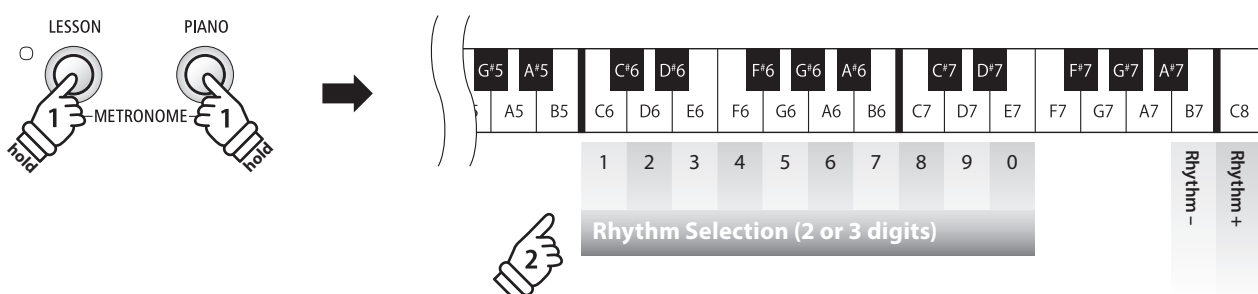

Registration Memories

The Registration function allows the current instrument setup (sound, certain settings, etc.) to be stored to a registration memory, and conveniently recalled at the touch of a button. Up to 4 different registration memories can be stored.

■ Settings stored in Registration memories

General	Settings
Selected sound	Keyboard and Sound Settings *
Dual Mode / Split Mode (Sounds, Volume balance)	Speaker EQ

* The Transpose setting will not be stored to Registration memories.

■ Selecting a Registration memory

Press the REGISTRATION button.

The LED indicator for the REGISTRATION button will turn on to indicate that the registration function is in use.

Press the LESSON or SOUND buttons to select the desired registration memory.

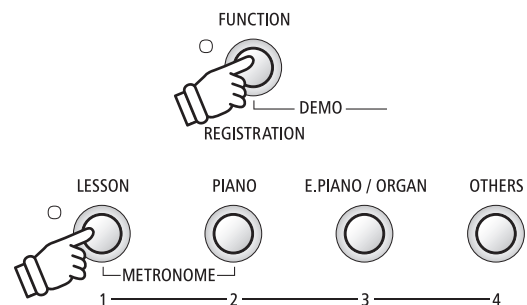

* The Metronome function will be disabled when using Registration mode.

■ Exiting Registration mode (restore previous settings)

To return to normal playing mode without selecting the registration (i.e. restore the previous panel settings):

Press the REGISTRATION button.

The LED indicator for the REGISTRATION button will turn off, and the instrument will return to normal playing mode.



■ Storing a Registration memory

Press and hold the REGISTRATION button, then press the LESSON or a SOUND button.

The current instrument setup will be stored to the registration memory assigned to the pressed LESSON or a SOUND button.

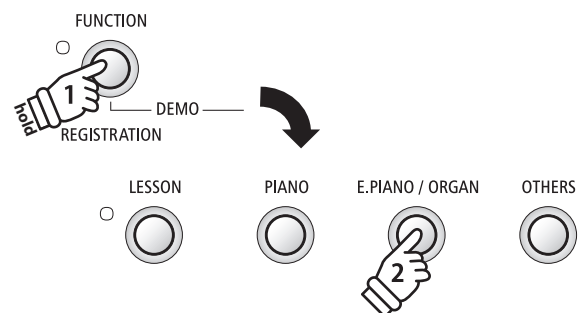

■ Resetting all Registration memories

Press and hold the FUNCTION and LESSON buttons, then turn the instrument's power off/on.

All registration memories will be reset to the factory default settings.

Demo Songs

The ES110 digital piano includes a selection of demonstration songs to introduce each internal sound.

■ Demo songs

Sound name	Song name	Composer
Concert Grand	Suite Bergamasque I. Prélude	C. Debussy
Concert Grand 2	Petit Chien	F. F. Chopin
Studio Grand	Original	Kawai
Mellow Grand	Sonata No.30 Op.109	L. v. Beethoven
Classic E.Piano	Original	Kawai
Modern E.Piano	Original	Kawai
Jazz Organ	Original	Kawai
Church Organ	Chorale Prelude "Wachet auf, ruft uns die Stimme"	J. S. Bach
Slow Strings	Original	Kawai
Electric Bass	Original	Kawai
Harpsichord	French Suite No. 6	J. S. Bach
Vibraphone	Original	Kawai

* Kawai regrets that sheet music for Kawai original demo songs is not available.

1. Playing the demo songs

Press the FUNCTION and PLAY / STOP buttons.

The LED indicators for the FUNCTION and PLAY / STOP buttons will start to flash and the Concert Grand demo song will start to play.

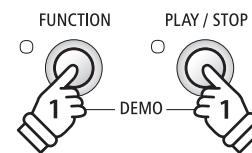

Press the FUNCTION and PLAY / STOP buttons again to stop the demo.

2. Selecting a demo song

While the demo is playing:

Press and hold the FUNCTION and PLAY / STOP buttons, then press the white key assigned to the desired demo song.

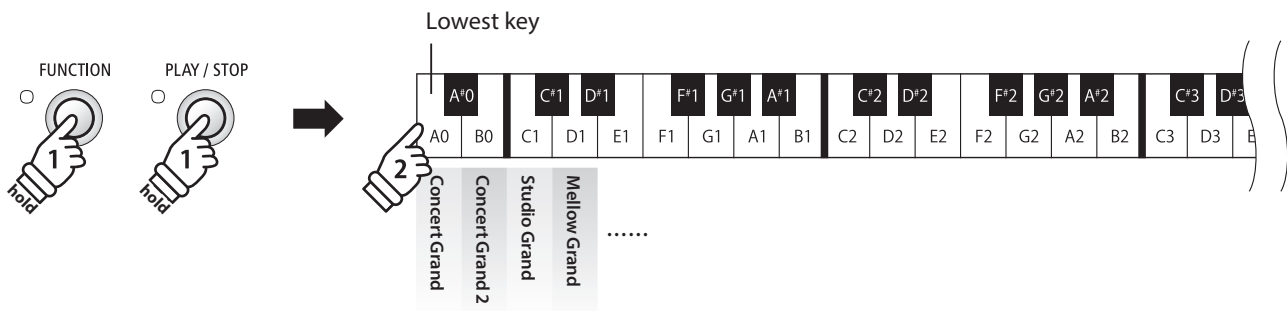

* It is also possible to cycle through the different demo songs in each category by pressing a SOUND button.

Lesson Function

The Lesson function allows budding pianists to practice the piano using a selection of built-in song books. The left and right hand parts for each piece can be practiced separately, while adjusting the tempo allows difficult passages to be perfected.

* For a complete listing of available Lesson Function songs, please refer to page 56 of this owner's manual.

■ Built-in lesson function song books

	US, Canada, Australasia	Rest of the World	Key
Book 1	Alfred's Basic Piano Library Lesson Book Level 1A	Burgmüller 25 (25 Etudes Faciles, Opus 100)	A#0
Book 2	Alfred's Basic Piano Library Lesson Book Level 1B	Alfred's Basic Piano Library Lesson Book Level 1A	C#1
Book 3	Burgmüller 25 (25 Etudes Faciles, Opus 100)	Alfred's Basic Piano Library Lesson Book Level 1B	D#1

1 Selecting a lesson book/song

1. Entering lesson mode

Press the LESSON button.

The LED indicator for the LESSON button will turn on, indicating that lesson mode is enabled, and the Concert Grand sound will be selected automatically.



2. Selecting the lesson book and song

While lesson mode is selected:

Press and hold the LESSON button, then press the black key assigned to the desired lesson book, and finally press the white key assigned to the desired lesson song.

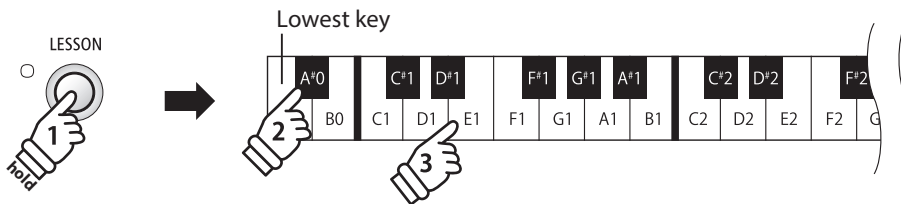

Example: To select lesson song 5 from book 1, press and hold the LESSON button, then press the A#0 key, and finally press the E1 key.

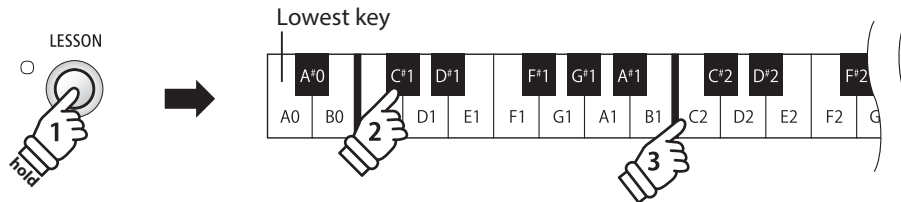

Example: To select lesson song 10 from book 2, press and hold the LESSON button, then press the C#1 key, and finally press the C2 key.

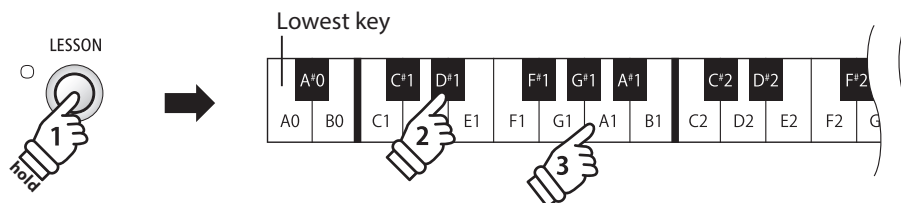

Example: To select lesson song 8 from book 3, press and hold the LESSON button, then press the D#1 key, and finally press the A1 key.

2 Listening to the selected lesson song

This page will explain how to play and stop the selected lesson song, and adjust the tempo.

■ Playing the lesson song

After selecting a lesson book and song:

Press the PLAY / STOP button.

The LED indicator for the PLAY / STOP button will turn on, and a one bar count-in will be heard before the song starts to play.

While the lesson song is playing, press the LESSON and PIANO buttons to turn the metronome on/off.

* The metronome time signature and tempo will automatically be set to that of the currently selected lesson song.

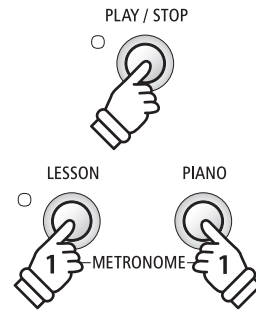

■ Adjusting tempo of the lesson song

While the lesson song is playing:

Press and hold the LESSON and PIANO buttons, enter the desired tempo using the lowest 12 white keys marked below.

- * The lesson song tempo can be adjusted within the range of 10~300 bpm.
- * The lesson song tempo can be entered precisely, or decreased and increased gradually.

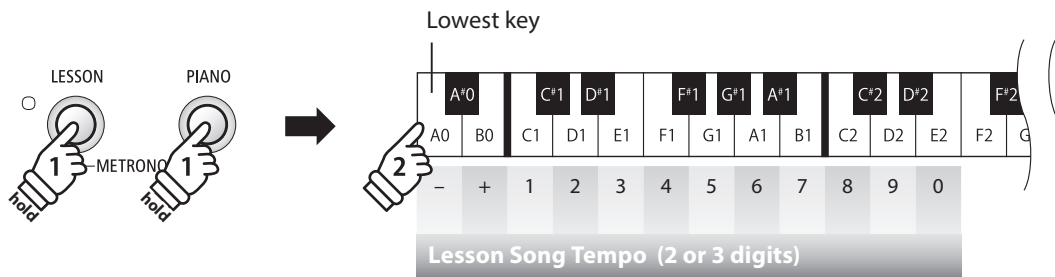

Method 1:

While pressing the LESSON and PIANO buttons, press keys 1, 5, and 0 to set the tempo to 150 bpm, or keys 8 and 5 to set the tempo to 85 bpm.

* The tempo will change when the 3rd digit is entered, or when the LESSON and PIANO buttons are released.

Method 2:

While pressing the LESSON and PIANO buttons, press the - / + keys repeatedly to gradually decrease or increase the tempo in 2 bpm increments.

■ Stopping the lesson song

While the lesson song is playing:

Press the PLAY / STOP button again to stop the lesson song.

The LED indicator for the PLAY / STOP button will turn off.

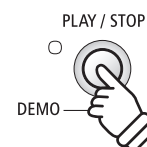

3 Practicing left and right-hand parts separately

This page will explain how to mute/activate the left and right-hand parts of the selected lesson song, allowing each part to be practiced separately.

■ Muting/activating lesson song parts

After selecting a lesson book and song:

Press the OTHERS button.

Press once:
Left-hand only



Press the OTHERS button again.

Press twice:
Right-hand only



Press the OTHERS button once again.

Press 3 times:
Left and Right-hand



■ Exiting lesson mode

Press the LESSON button.

The LED indicator for the LESSON button will turn off, and the instrument will return to normal operation.



Recorder

The ES110 digital piano allows up to 3 different songs to be recorded, stored in internal memory, and played back at the touch of a button.

1 Recording a song

1. Selecting a song memory

Press and hold the REC button, then press one of the lowest three white keys to select the desired song memory.

* Selecting a song memory that has already been used to record a song will automatically erase the previously recorded song.

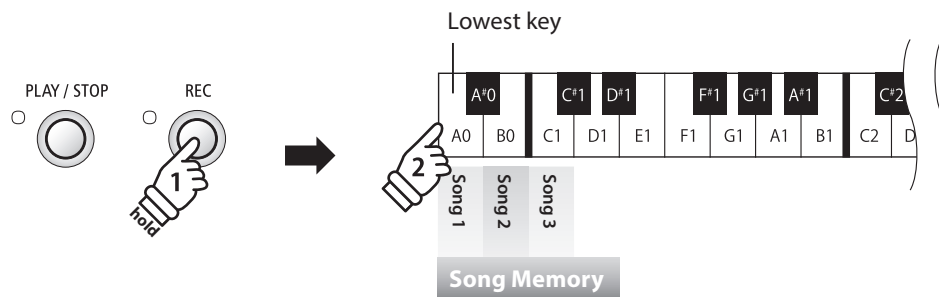

2. Starting the song recorder

Press a key on the keyboard.

The LED indicators for the REC and PLAY / STOP buttons will turn on, and recording will start.

* Recording can also be started by pressing the PLAY / STOP button, allowing a rest period or empty bar to be inserted at the beginning of the song.



3. Stopping the song recorder

Press the PLAY / STOP button.

The LED indicators for the PLAY / STOP and REC buttons will flash briefly, and the song will be stored in internal memory.

* Do not turn the power off while the song is saving to memory.

* The maximum recording capacity is approximately 15,000 notes, with button and pedal presses also counted as one note. If the maximum recording capacity is reached during recording, the recorder will stop automatically.

* Recorder songs will remain in memory after the power is turned off.

2 Playing back a song

1. Playing the recorded song

Press the PLAY / STOP button.

The LED indicator for the PLAY / STOP button will turn on, and the recorded song will start to play.

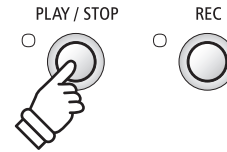

2. Playing a song stored in another memory

Press and hold the PLAY / STOP button, then press one of the lowest three white keys to play the desired song memory.

* The selected song will start to play when the PLAY / STOP button is released.

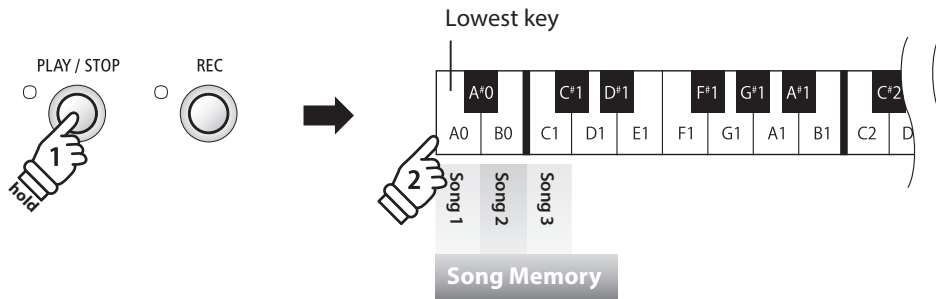

3 Erasing recorded songs



Warning: This process will erase all three songs stored in internal memory, and cannot be undone.

■ Erasing the recorder songs

Press and hold the PLAY / STOP and REC buttons simultaneously, then turn the instrument's power off/on.

All recorder songs stored in memory will be erased.

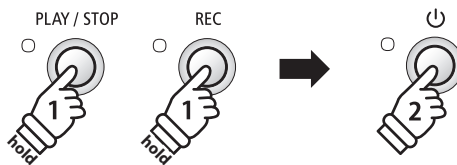

Keyboard and Sound Settings

The ES110's keyboard and sound settings allow various aspects of the instrument to be adjusted.

Keyboard and Sound Settings

Setting name	Explanation	Default setting
Reverb	Change the type of reverberation added to the sound.	Room
Damper Resonance	Adjust the resonance that is heard when depressing the damper pedal.	Medium
Voicing	Adjust the tonal character of the instrument.	Normal
Fall-back Noise	Adjust the sound that is heard when the key action falls back.	Normal
Damper Noise	Adjust the sound that is heard when pressing the damper pedal.	Normal
Transpose	Increase or decrease the pitch of the keyboard in semi-tone steps.	0
Brilliance	Adjust the brightness of the sound.	Off
Touch	Change the touch sensitivity of the keyboard.	Normal
Tuning	Increase or decrease the pitch of the keyboard in 0.5 Hz steps.	440.0 Hz
Temperament	Adjust the tuning system to suit Renaissance and Baroque periods etc.	Equal Temp.
Temperament Key	Adjust the key of the selected tuning system.	C
Effect On/Off	Enable or disable the effect applied to the sound.	On

Changing Settings

Press and hold a SOUND button, then press the key(s) assigned to the desired setting.

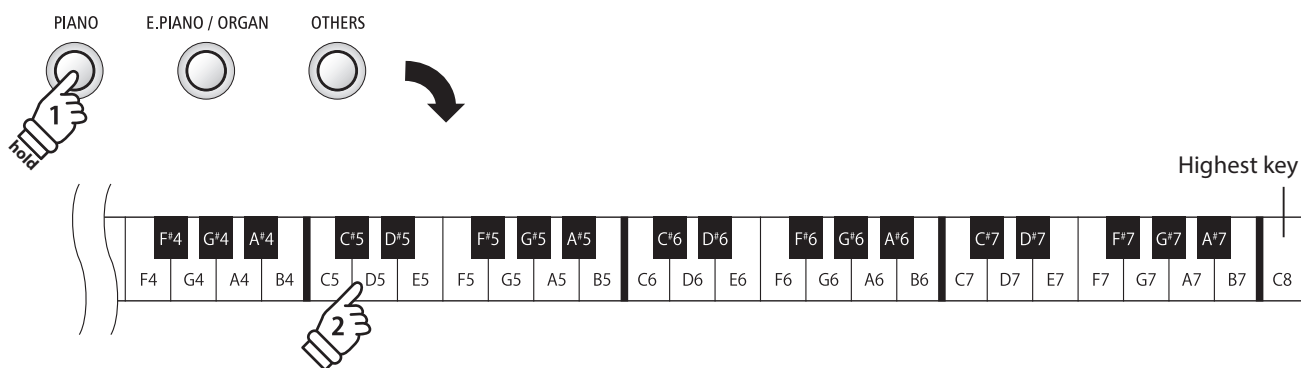

1 Reverb

The Reverb setting adds reverberation to the sound, simulating the acoustic environment of a recital room, small hall, or concert hall. The most suitable reverb type is applied automatically when selecting each sound, however it is also possible to select a different reverb type manually if desired.

* This setting will affect all sounds.

■ Reverb type

Reverb type	Description	Key
Off	Disables the reverb.	A2
Room	Simulates the ambiance of a small rehearsal room.	E2
Small Hall	Simulates the ambiance of a small hall.	F2
Concert Hall	Simulates the ambiance of a concert hall or theater.	G2

■ Changing the Reverb type

Press and hold a SOUND button, then press the key assigned to the desired Reverb type.

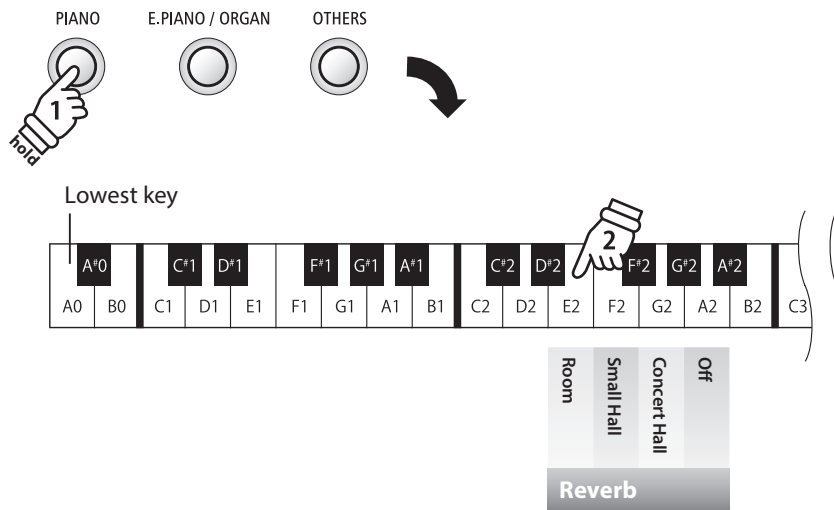

* To disable Reverb, press the key assigned to the 'Off' setting.

If Reverb is disabled, it will be turned on automatically upon selecting a reverb type.

* Any changes made to the Reverb setting will remain until the power is turned off.

* Preferred Reverb settings can be stored to a Registration memory for convenient recall, or to the Startup Setting memory for automatic selection when the instrument is turned on. Please refer to pages 19 and 49 for more information.

2 Damper Resonance

Depressing the sustain pedal of an acoustic piano raises all dampers, allowing the strings to vibrate freely. When a note or chord is played on the piano with the sustain pedal depressed, not only will the strings of the notes played vibrate, but also the strings of other notes, vibrating in sympathetic resonance.

The ES110 digital piano recreates this phenomenon, with the Damper Resonance setting allowing the volume of this resonance to be changed.

* This setting will affect PIANO sounds only.

■ Damper Resonance volume

Damper Resonance volume	Description	Key
Off	Disables the damper resonance.	F3
Small	Piano sounds will produce a small amount of damper resonance.	C3
Medium (default)	Piano sounds will produce a medium amount of damper resonance.	D3
Large	Piano sounds will produce a large amount of damper resonance.	E3

■ Changing the Damper Resonance volume

Press and hold the PIANO button, then press the key assigned to the desired Damper Resonance volume.

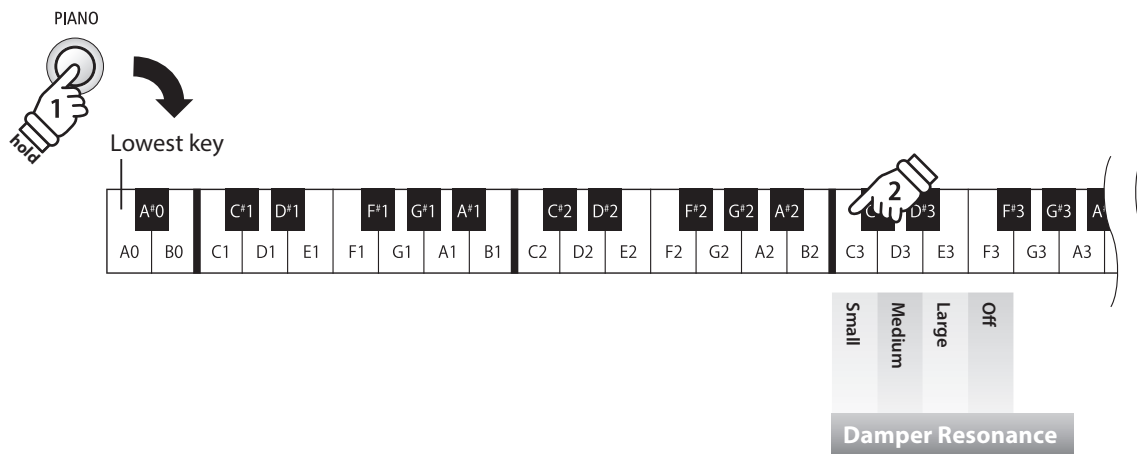

- * To disable Damper Resonance, press the key assigned to the 'Off' setting. If Damper Resonance is disabled, it will be turned on automatically upon selecting a damper resonance type.
- * Any changes made to the Damper Resonance setting will remain until the power is turned off.
- * Preferred Damper Resonance settings can be stored to a Registration memory for convenient recall, or to the Startup Setting memory for automatic selection when the instrument is turned on. Please refer to pages 19 and 49 for more information.

3 Voicing

On an acoustic piano, the shape, density, and texture of the hammers all influence the tonal character of the instrument's sound. Technicians utilise a variety of tools such as needles, files, and brushes to manipulate these hammer felts, with the ultimate goal of achieving a balanced tonal character across the keyboard.

The Voicing setting recreates various hammer properties, allowing the overall tonal character of the ES110 digital piano to be set to one of four different types.

While the default 'Normal' voicing setting should be appropriate for a broad range of musical genres, it may be desirable to select a softer, more mellow tonal character for romantic pieces, or a brighter, more aggressive tone for modern styles.

* This setting will affect all sounds.

Voicing type

Voicing type	Description	Key
Normal (default)	The normal tonal character of an acoustic piano throughout the entire dynamic range.	C4
Mellow	A softer, more mellow tonal character throughout the entire dynamic range.	D4
Dynamic	A tonal character that changes dramatically from mellow to bright, depending on the strength of key strike.	E4
Bright	A bright tonal character throughout the entire dynamic range.	F4

Changing the Voicing type

Press and hold a SOUND button, then press the key assigned to the desired Voicing type.

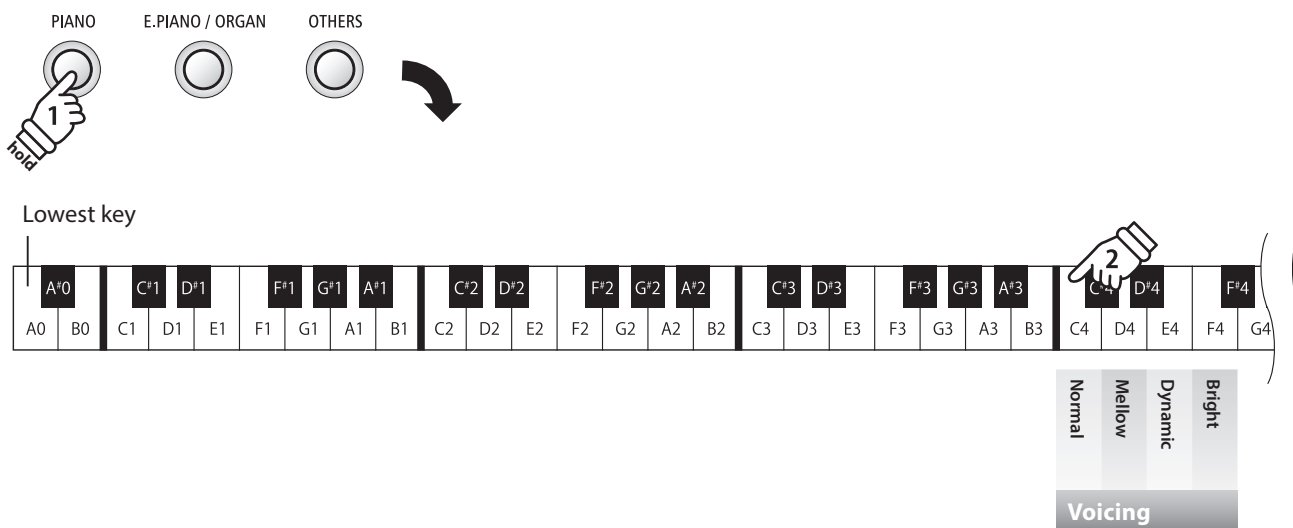

* Any changes made to the Voicing setting will remain until the power is turned off.

* Preferred Voicing settings can be stored to a Registration memory for convenient recall, or to the Startup Setting memory for automatic selection when the instrument is turned on. Please refer to pages 19 and 49 for more information.

4 Fall-back Noise

When playing an acoustic piano, it is often possible to hear the faint sound of the keyboard action returning (i.e. 'falling back') to the neutral position after a key is released.

The ES110 digital piano reproduces this sound, with the Fall-back Noise setting allowing the volume of this sound to be changed.

While the default value is intended to simulate the natural volume level of the keys as they return to their neutral position, it may occasionally be desirable to adjust the volume of this sound. For example, reducing the volume when playing very soft pieces, where the fall-back noise may become too prominent.

* This setting will affect PIANO sounds only.

■ Fall-back Noise volume

Fall-back Noise volume	Description	Key
Off	Disables the fall-back noise.	D5
Small	Piano sounds will produce a small amount of fall-back noise.	B4
Normal (default)	Piano sounds will produce a normal amount of fall-back noise.	A4
Large	Piano sounds will produce a large amount of fall-back noise.	C5

■ Changing the Fall-back Noise volume

Press and hold the PIANO button, then press the key assigned to the desired Fall-back Noise volume.

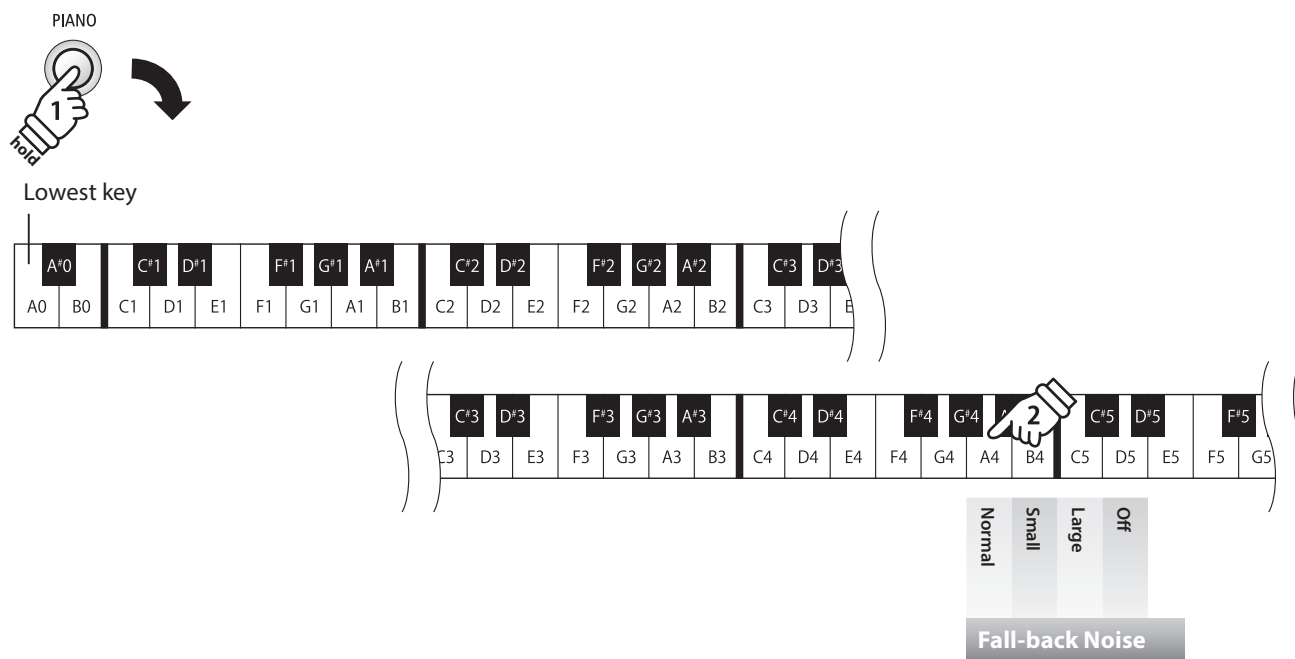

* To disable the Fall-back Noise, press the key assigned to the 'Off' setting.

If Fall-back Noise is disabled, it will be turned on automatically upon selecting a fall-back noise type.

* Any changes made to the Fall-back Noise setting will remain until the power is turned off.

* Preferred Fall-back Noise settings can be stored to a Registration memory for convenient recall, or to the Startup Setting memory for automatic selection when the instrument is turned on. Please refer to pages 19 and 49 for more information.

5 Damper Noise

When the damper pedal of an acoustic piano is pressed and released, it is often possible to hear the sound of the damper head touching and releasing the strings.

The ES110 digital piano reproduces this sound, with the Damper Noise setting allowing the volume of this sound to be changed.

The speed at which the damper pedal is pressed will also influence the prominence of the damper noise, with fast pedalling creating a very pronounced sound.

* This setting will affect PIANO sounds only.

Damper Noise volume

Damper Noise volume	Description	Key
Off	Disables the damper noise.	B5
Small	Piano sounds will produce a small amount of damper noise.	G5
Normal (default)	Piano sounds will produce a normal amount of damper noise.	F5
Large	Piano sounds will produce a large amount of damper noise.	A5

Changing the Damper Noise volume

Press and hold the PIANO button, then press the key assigned to the desired Damper Noise volume.

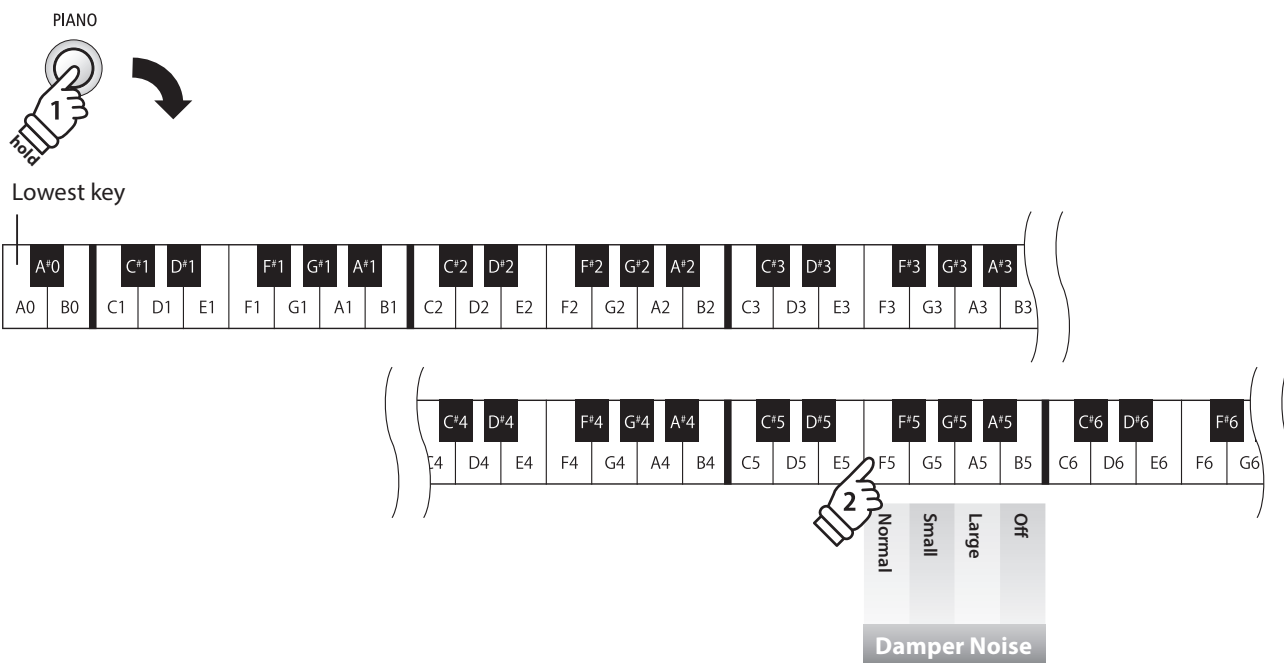

- * To disable the Damper Noise, press the key assigned to the 'Off' setting. If Damper Noise is disabled, it will be turned on automatically upon selecting a damper noise type.
- * Any changes made to the Damper Noise setting will remain until the power is turned off.
- * Preferred Damper Noise settings can be stored to a Registration memory for convenient recall, or to the Startup Setting memory for automatic selection when the instrument is turned on. Please refer to pages 19 and 49 for more information.

6 Transpose

The Key Transpose setting allows the pitch of the ES110 digital piano keyboard to be raised or lowered in semi-tone steps. This is particularly useful when accompanying instruments with different tones, or when a song learned in one key must be played in another key. When transposed, the song can be played in the original key, yet heard in a different key.

* This setting will affect all sounds.

■ Adjusting the Transpose setting

Press and hold a SOUND button, then press the keys assigned -/+ to lower or raise the keyboard pitch in semi-tone steps.

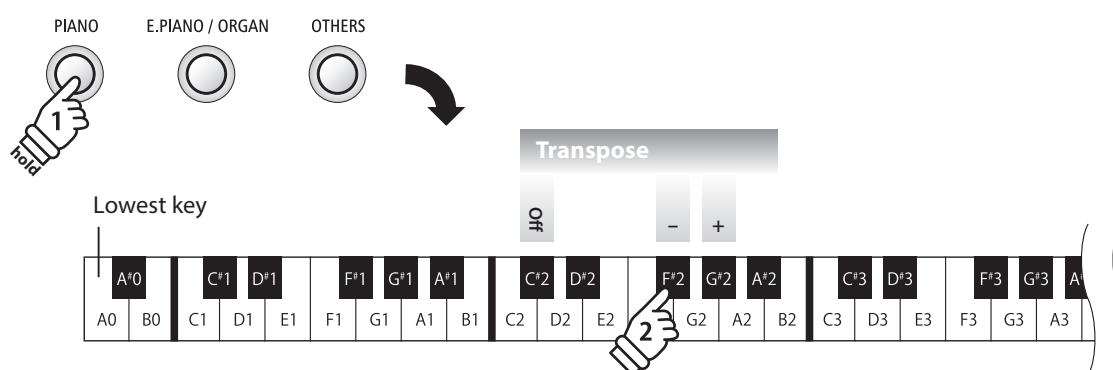

- * The keyboard pitch can be raised or lowered by up to 12 semi-tones.
- * To disable the Transpose setting, press the key assigned to the 'Off' setting.
- * Any changes made to the Transpose setting will remain until the power is turned off.
- * The Transpose setting cannot be stored to Registration or Startup Setting memory.

7 Brilliance

The Brilliance setting allows the brightness of the ES110 digital piano's sound to be adjusted independently of the 'Voicing' setting.

* This setting will affect all sounds.

■ Adjusting the Brilliance setting

Press and hold a SOUND button, then press the keys assigned -/+ to adjust the brightness of the sound.

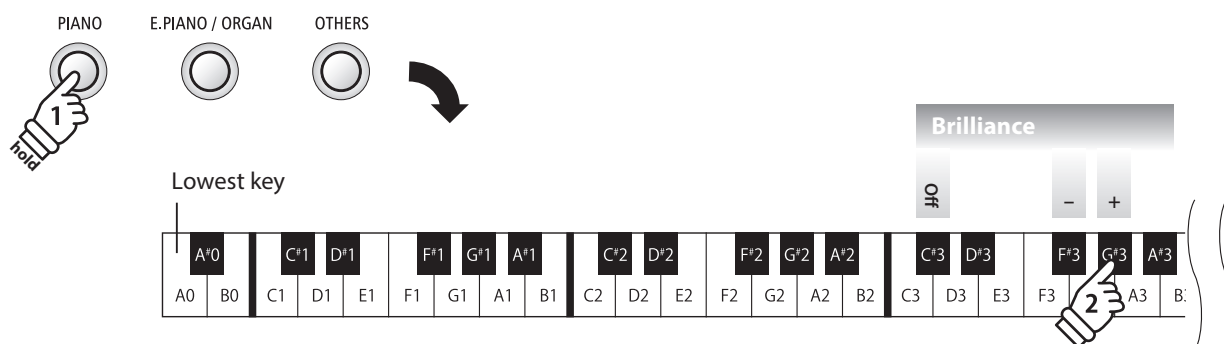

* The Brilliance setting can be adjusted within the range of -10~+10, with +10 being the brightest setting.

* To disable the Brilliance setting, press the key assigned to the 'Off' setting.

* Any changes made to the Brilliance setting will remain until the power is turned off.

* Preferred Brilliance settings can be stored to a Registration memory for convenient recall, or to the Startup Setting memory for automatic selection when the instrument is turned on. Please refer to pages 19 and 49 for more information.

8 Touch

As with an acoustic piano, the ES110 digital piano produces a louder sound when the keys are struck with force, and a softer sound when the keys are played gently. The volume and tonal character change in relation to the strength and speed of playing – on a digital piano this system is referred to as ‘touch sensitivity’.

The Touch setting allows the touch sensitivity of the keyboard to be conveniently changed. There are four different preset touch settings available.

* This setting will affect all sounds.

■ Touch type

Touch type	Description	Key
Off	A constant volume is produced regardless of how hard the keys are struck. This setting is recommended for sounds that have a fixed dynamic range such as organ and harpsichord.	C#4
Light	A louder volume is produced even when playing with a soft touch. This setting is recommended for children and organ players, or for those still developing finger strength.	G#4
Normal (default)	Reproduces the standard touch sensitivity of an acoustic piano.	F#4
Heavy	Requires a heavier touch to produce a loud volume. This setting is recommended to those with stronger fingers.	A#4

■ Changing the Touch type

Press and hold a SOUND button, then press the key assigned to the desired touch type.

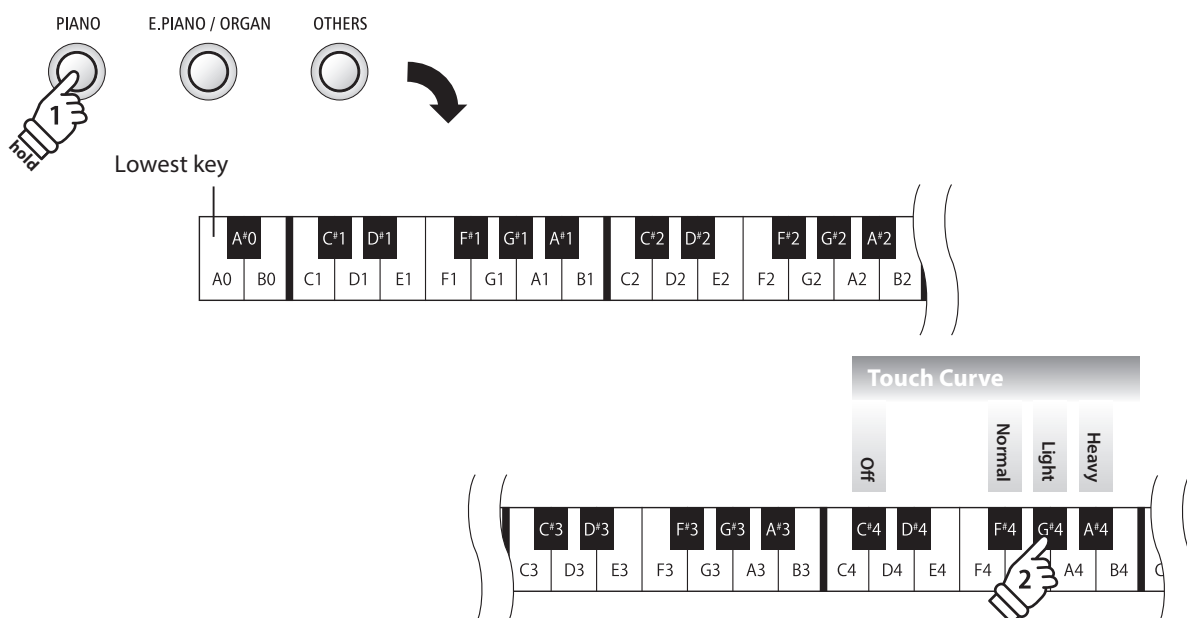

* Any changes made to the Touch setting will remain until the power is turned off.

* Preferred Touch settings can be stored to a Registration memory for convenient recall, or to the Startup Setting memory for automatic selection when the instrument is turned on. Please refer to pages 19 and 49 for more information.

9 Tuning

The Tuning setting allows the overall pitch of the ES110 digital piano to be raised and lowered in 0.5 Hz steps, and may therefore prove useful when playing with other instruments.

* This setting will affect all sounds.

■ Adjusting the Tuning setting

Press and hold a SOUND button, then press the keys assigned -/+ to lower or raise the keyboard pitch in 0.5 Hz steps.

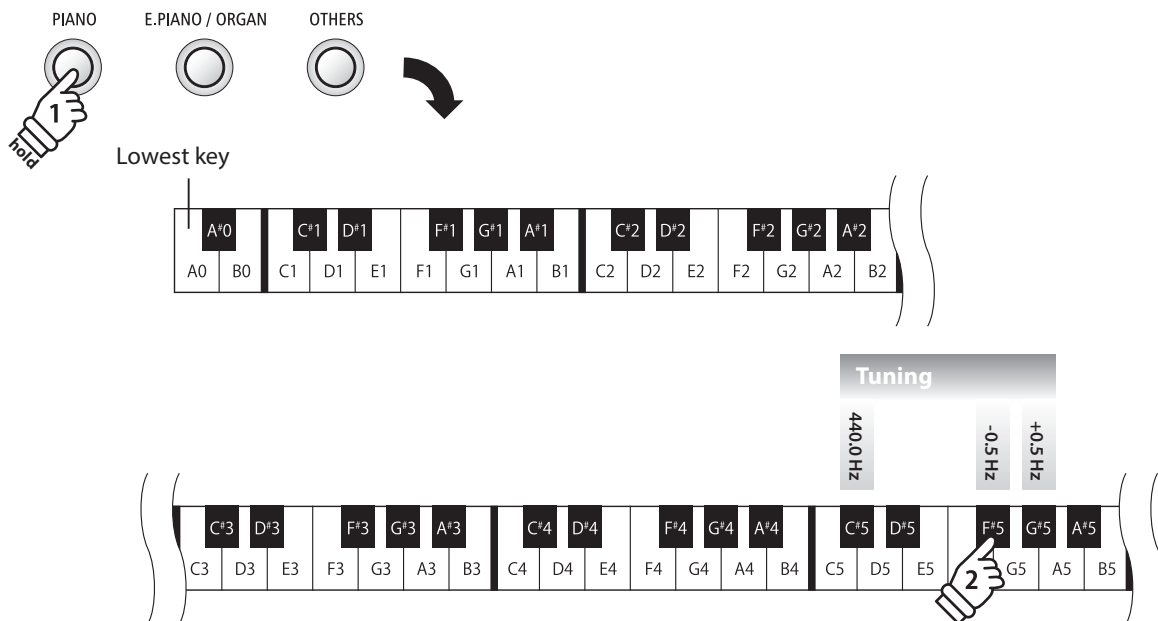

* The keyboard pitch can be adjusted within the range of 427~453 Hz.

* To reset the pitch to 440.0 Hz, press the Reset key indicated above.

* Any changes made to the Tuning setting will remain until the power is turned off.

* Preferred Tuning settings can be stored to a Registration memory for convenient recall, or to the Startup Setting memory for automatic selection when the instrument is turned on. Please refer to pages 19 and 49 for more information.

10 Temperament

The Temperament setting allows the tuning system used by the ES110 digital piano to be changed from the modern 'Equal Temperament' standard to one of the various temperaments popularised during the Renaissance and Baroque periods.

* This setting will affect all sounds.

■ Temperament types

Temperament type	Description
Equal Temperament (piano)	This is the default temperament. When a piano sound is selected, the tuning will be stretched like an acoustic piano (equal temperament). * If any other type of sound is selected, the tuning will be set to equal temperament (flat).
Pure Temperament (Pure Major/Pure Minor)	This temperament, which eliminates dissonances for thirds and fifths, is still popular in choral music because of its perfect harmony. Any key modulation will result in dissonances. * The key of the temperament, and major/minor setting must be correctly matched.
Pythagorean Temperament	This temperament, which uses mathematical ratios to eliminate dissonance for fifths, is very limited for use with chords, but produces very characteristic melodic lines.
Meantone Temperament	This temperament, which uses a mean between a major and minor whole tone to eliminate dissonance for thirds, was devised to eliminate the lack of consonances experienced with certain fifths for the Mersenne pure temperament. It produces chords that are more beautiful than those played with equal temperament.
Werckmeister III Temperament Kirnberger III Temperament	These two temperaments are placed in between Meantone and Pythagorean. For music with few accidentals, this temperament produces the beautiful chords of the mean tone, but as accidentals increase, the temperament produces the characteristic melodies of the Pythagorean temperament. It is used primarily for classical music written in the Baroque era to revive the original characteristics.

■ Changing the Temperament type

Press and hold a SOUND button, then press the key assigned to the desired Temperament type.

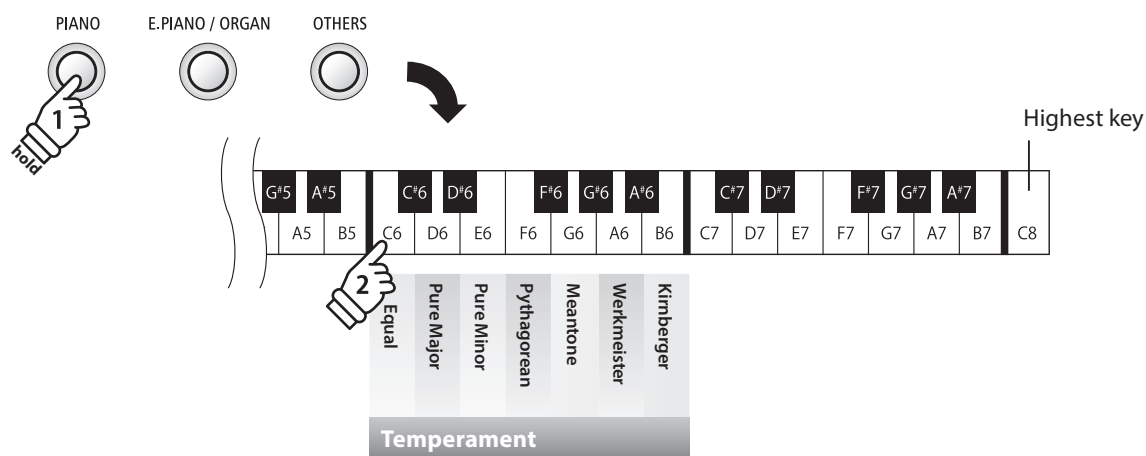

* Any changes made to the Temperament setting will remain until the power is turned off.

* Preferred Temperament settings can be stored to a Registration memory for convenient recall, or to the Startup Setting memory for automatic selection when the instrument is turned on. Please refer to pages 19 and 49 for more information.

11 Temperament Key

The Temperament Key setting allows the key of the selected temperament to be specified. When using a temperament other than Equal temperament, use this setting to specify the key signature of the piece.

* This setting will affect all sounds.

■ Changing the Temperament Key

Press and hold a SOUND button, then press the key assigned to the desired Temperament key.

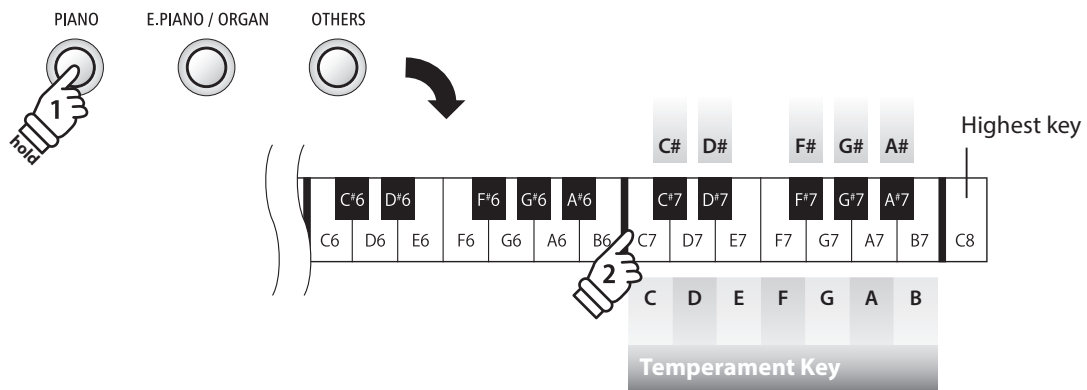

* Any changes made to the Temperament Key setting will remain until the power is turned off.

* Preferred Temperament Key settings can be stored to a Registration memory for convenient recall, or to the Startup Setting memory for automatic selection when the instrument is turned on. Please refer to pages 19 and 49 for more information.

12 Effect On/Off

As with reverb, selecting certain sounds automatically applies additional effects intended to enhance tonal quality. However, it may sometimes be desirable to disable/enable these effects manually, depending on the style of music or song being played.

The Effect On/Off setting allows effects applied to certain sounds to be enabled/disabled.

■ Effect On/Off

Effect On/Off	Description	Key
Off	Disables the additional effects applied to the sound.	G#6
On	Enables the additional effects applied to the sound.	F#6

■ Sounds & Effect types

Sound	Effect applied	Default
Classic E.Piano	Auto Pan	On
60's E.Piano	Classic Tremolo	On
Modern E.Piano	Classic Chorus	On
Jazz Organ	Rotary	On
Vibraphone	Classic Tremolo	On
All other sounds	Classic Chorus	Off

* When the Jazz Organ sound is selected, the fast/slow speed of the applied Rotary effect can be changed by pressing the FUNCTION and REC buttons simultaneously.

■ Changing the Effect On/Off setting

Press and hold a SOUND button, then press the keys assigned to enable/disable the effect.

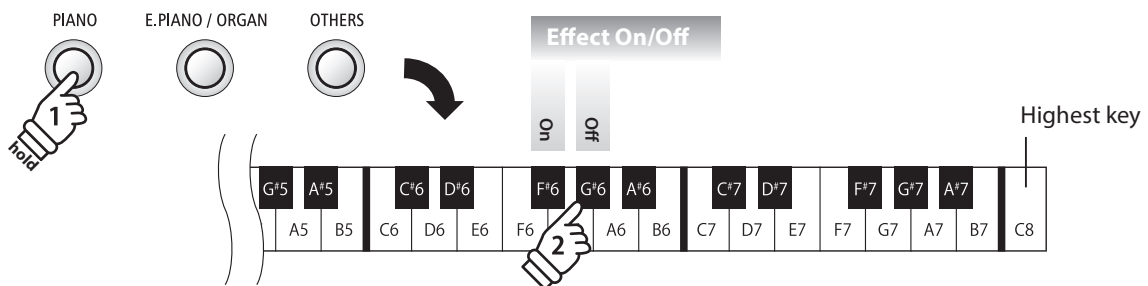

* The Effect On/Off setting can be changed independently for each sound.

* Any changes made to the Effect On/Off setting will remain until the power is turned off.

* Preferred Effect On/Off settings can be stored to a Registration memory for convenient recall, or to the Startup Setting memory for automatic selection when the instrument is turned on. Please refer to pages 19 and 49 for more information.

MIDI Settings

The term MIDI is an acronym for Musical Instrument Digital Interface, an international standard for connecting musical instruments, computers, and other devices to allow the exchange of performance data.

■ MIDI terminals

MIDI terminal	Function
MIDI IN	Receiving note, program change, and other data.
MIDI OUT	Sending note, program change, and other data.

■ MIDI channels

MIDI uses channels to exchange data back and forth between MIDI devices. There are receive (MIDI IN) and transmit (MIDI OUT) channels. Most musical instruments or devices with MIDI functions are equipped with both MIDI IN and OUT jacks and are capable of transmitting and receiving data via MIDI. The receive channels are used to receive data from another MIDI device and the transmit channels are used to transmit data to another MIDI device.

The illustration below shows three musical instruments, connected together using MIDI.

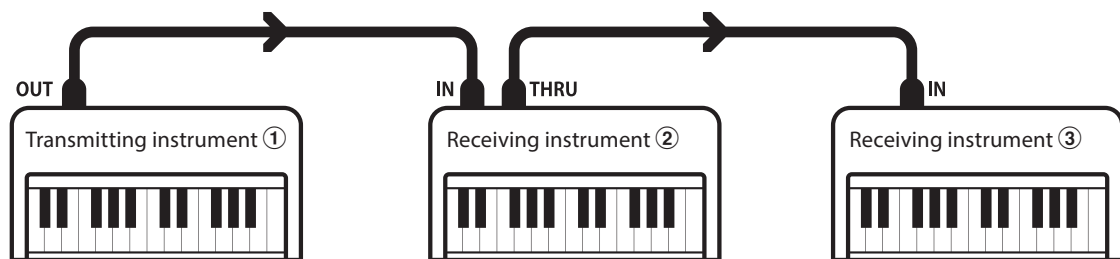

Transmitting instrument ① sends transmit channel and keyboard information to receiving instruments ②/③.

The information arrives at the receiving instruments ②/③.

Receiving instruments ②/③ will respond to MIDI data that is sent if their receive channel is the same as the transmit channel of the transmitting instrument ①.

If the channels do not match, then the receiving instruments ②/③ will not respond to any data that is sent.

For both receiving and transmitting, channels 1~16 can be used.

■ Recording/playing with a sequencer

When connected to a sequencer, the ES110 digital piano can be used to record and playback multi-track songs, with separate sounds playing simultaneously on each channel.

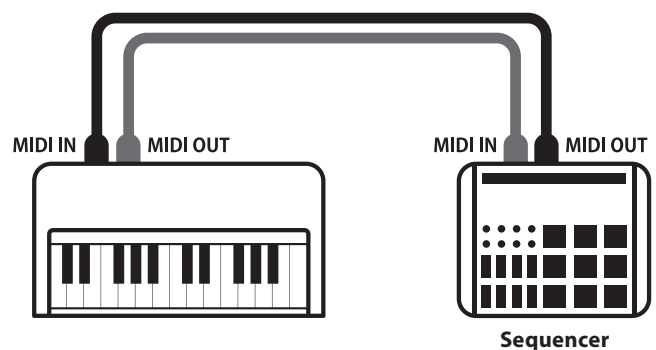

MIDI Settings

■ MIDI functions

The ES110 digital piano supports the following MIDI functions:

Transmit/receive note information Transmit/receive note information from a MIDI-connected musical instrument or device.	Transmit/receive Program Change number Transmit/receive program change data to/from a MIDI-connected musical instrument or device.
Transmit/receive channel settings Specify transmit/receive channels within the range of 1~16.	Transmit/receive pedal data Transmit/receive sustain, sostenuto, and soft pedal data from a MIDI-connected musical instrument or device.
Transmit/receive exclusive data Transmit/receive front panel or menu function settings as exclusive data.	Receive volume data Receive MIDI volume data sent from a MIDI-connected musical instrument or device.
Multi-timbral mode setting Receive multiple channel MIDI data from a MIDI-connected musical instrument or device. * Multi-timbral mode setting must be enabled.	* Please refer to the 'MIDI Implementation Chart' on page 59 for further information regarding the MIDI capabilities of the ES110 digital piano.

■ MIDI settings

Function name	Explanation	Default setting
Transmit MIDI Program Change	Specify whether or not program change information is sent when sounds are changed. Send a MIDI program change number from 1 to 128.	On
MIDI Channel	Specify the channel used to transmit/receive MIDI information.	1ch
Local Control	Specify whether or not internal sounds will be heard when the keyboard is pressed.	On
Multi-timbral Mode	Specify whether or not MIDI information can be received on more than one channel.	Off

■ Changing MIDI settings

Press and hold the FUNCTION button, then press the key(s) assigned to the desired functions.

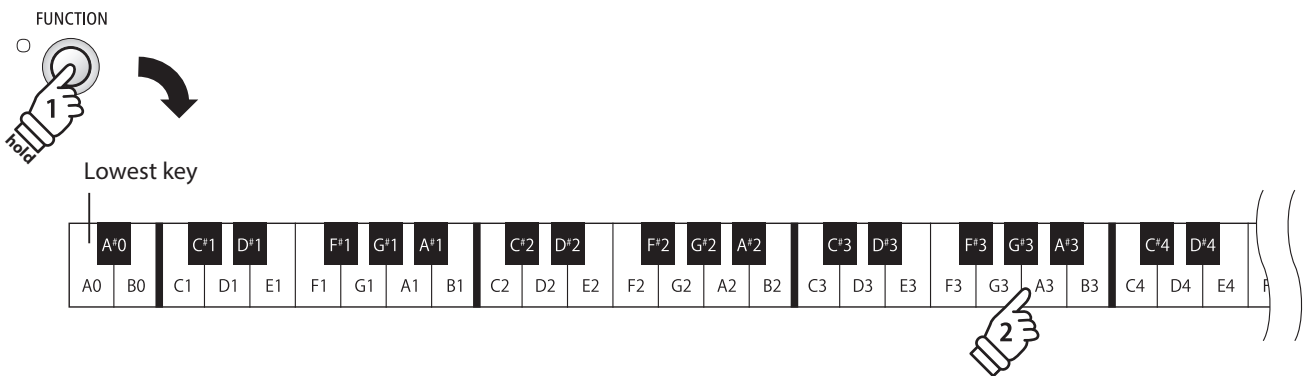

1 Transmit MIDI Program Change

The Send Program Change Number setting determines whether or not the ES110 digital piano will transmit program change information when sounds are changes. It is also possible to transmit a program change number (ranging from 1 to 128) in order to change the sound of an external MIDI device.

■ Transmit MIDI Program Change settings

Transmit PGM#	Explanation	Key
Off	The instrument will NOT transmit program change numbers when changing sounds.	C#1
On (default)	The instrument will transmit program change numbers when changing sounds.	D#1

■ Changing the Transmit MIDI Program Change setting

Press and hold the FUNCTION button, then press the key assigned to the desired Transmit MIDI Program Change setting.

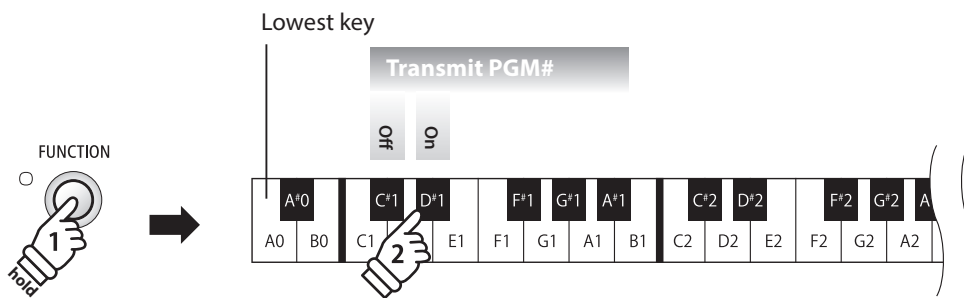

* Any changes made to the Transmit MIDI Program Change setting will remain until the power is turned off.

* Preferred Transmit MIDI Program Change settings can be stored to the Startup Setting memory for automatic selection when the instrument is turned on. Please refer to page 49 for more information.

■ Sending a Program Change number

Press and hold the FUNCTION button, then enter the desired program change number to send using the number keys indicated below.

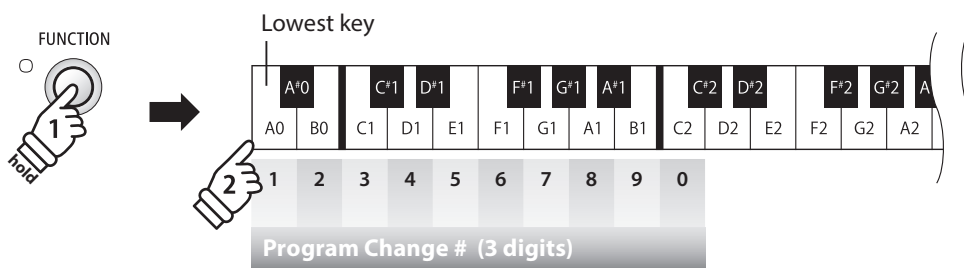

Example: Transmit PGM#064

Enter 0, 6, then 4

* Program change numbers are specified as three digits within the range of 001~128.

* The program change number will be transmitted automatically when the key for the third digit number is pressed.

2 MIDI Channel (transmit/receive)

The MIDI Channel setting allows the transmit/receive channel to be specified. The selected channel will function as both the transmit and receive channel (separate transmit/receive channels cannot be specified).

■ Changing the MIDI Channel setting

Press and hold the FUNCTION button, then press the key assigned to the desired MIDI channel.

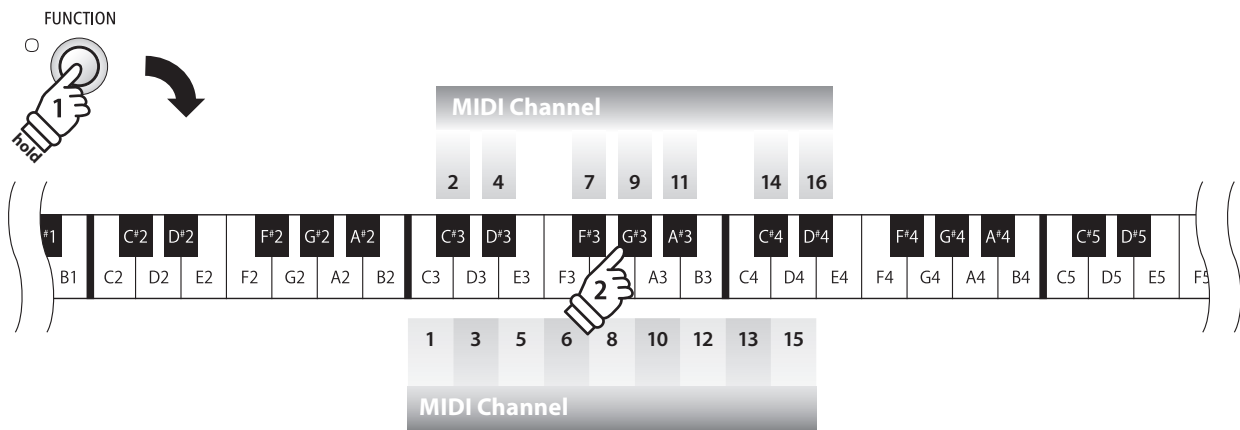

- * The MIDI channel can be specified within the range of 1~16.
- * The MIDI channel is automatically set to '1' when the instrument is turned on (default setting).
- * Preferred MIDI Channel settings can be stored to the Startup Setting memory for automatic selection when the instrument is turned on. Please refer to page 49 for more information.

3 Local Control

The Local Control setting determines whether the instrument will play an internal sound when the keys are pressed. This setting may be useful when using the ES110 digital piano to control an external MIDI device.

Local Control settings

Local Control	Explanation	Key
Off	The instrument will transmit information to an external MIDI device only.	C#5
On (default)	The instrument will play an internal sound and transmit information to an external MIDI device.	D#5

Changing the Local Control setting

Press and hold the FUNCTION button, then press the key assigned to the desired Local Control setting.

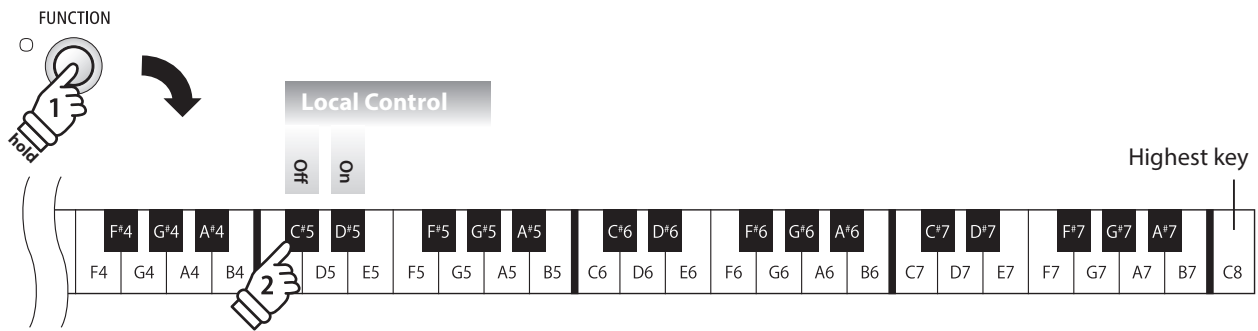

- * Any changes made to the Local Control setting will remain until the power is turned off.
- * Preferred Local Control settings can be stored to the Startup Setting memory for automatic selection when the instrument is turned on. Please refer to page 49 for more information.

4 Multi-timbral Mode

The Multi-timbral mode setting determines whether or not the ES110 digital piano is able to receive MIDI information on more than one MIDI channel simultaneously. This allows the instrument to play back multi-track, multi-timbral performance data sent from an external MIDI device.

Multi-timbre settings

Multi-timbre	Explanation	Key
Off (default)	Multi-timbral mode disabled	C#6
On	Multi-timbral mode enabled*	D#6

* Please refer to the 'Program Change Number List' below.

Changing the Multi-timbral mode setting

Press and hold the FUNCTION button, then press the key assigned to the desired Multi-timbre setting.

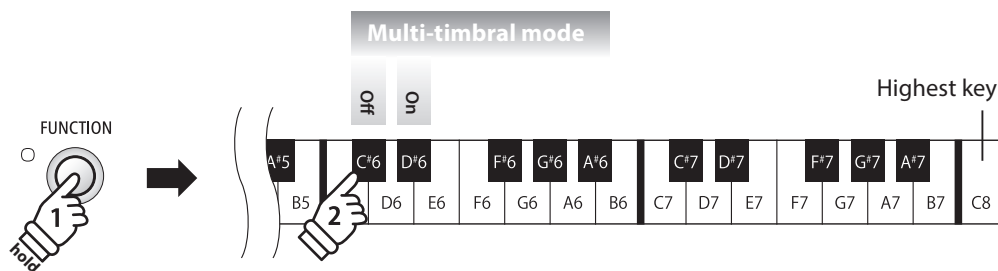

* MIDI data received through channel 10 will not be performed when Multi-timbre is enabled.

Program Change Number List

Sound name	Multi-timbral mode Off		Multi-timbral mode On	
	Program number	Program number	Bank MSB	Bank LSB
Concert Grand	1	1	121	0
Concert Grand 2	2	1	95	16
Studio Grand	3	1	121	1
Studio Grand 2	4	1	95	17
Mellow Grand	5	1	121	2
Mellow Grand 2	6	1	95	18
Modern Piano	7	2	121	0
Rock Piano	8	2	121	1
Classic E.Piano	9	5	121	0
60's E.Piano	10	5	121	3
Modern E.Piano	11	6	121	0
Jazz Organ	12	18	121	0
Church Organ	13	20	121	0
Slow Strings	14	45	95	1
String Ensemble	15	49	121	0
Wood Bass	16	33	121	0
Electric Bass	17	34	121	0
Harpichord	18	7	121	0
Vibraphone	19	12	121	0

Speaker Settings

1 Speaker EQ

The Speaker EQ setting optimises the sound character of the ES110 digital piano's speaker system, depending on whether the instrument is placed on a table, or on a stand. It is also possible to disable speaker EQ to ensure optimum sound quality when using the instrument's Line Out connectors.

* This setting does not affect the sound heard when listening with headphones.

■ Speaker EQ settings

Speaker EQ	Description	Key
Normal (default)	Optimise the speaker EQ for placing the ES110 digital piano on a stand.	F#6
Table	Optimise the speaker EQ for placing the ES110 digital piano on a table.	G#6
Off	Disable the speaker EQ for optimum results when using the Line Out connectors.	A#6

■ Changing the Speaker EQ setting

Press and hold the FUNCTION button, then press the key assigned to the desired the Speaker EQ setting.

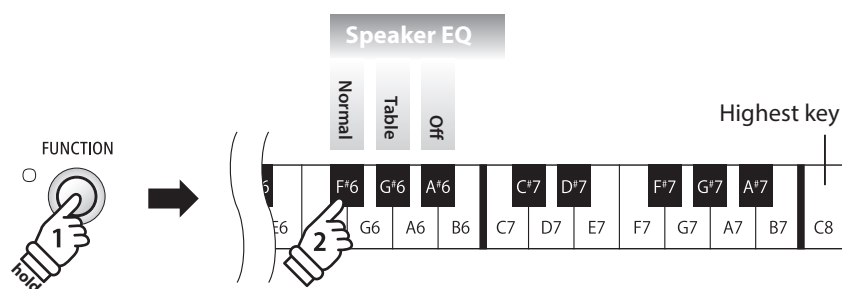

* Any changes made to the Speaker EQ setting will remain until the power is turned off.

* Preferred Speaker EQ settings can be stored to a Registration memory for convenient recall, or to the Startup Setting memory for automatic selection when the instrument is turned on. Please refer to pages 19 and 49 for more information.

2 Speakers On/Off

The Speaker On/Off setting is used to enable or disable the ES110 digital piano's built-in speakers. This function may be useful when connecting the instrument to external speakers or an amplification system via the Line Out jacks, and the built-in speakers are not required.

* The instrument's built-in speakers can also be muted by connecting a pair of headphones to the Phones connectors.

■ Speakers On/Off settings

Speakers On/Off	Explanation	Key
Off	Disables the instrument's built-in speakers.	C#7
On (default)	Enables the instrument's built-in speakers.	D#7

■ Changing the Speaker On/Off setting

Press and hold the FUNCTION button, then press the key assigned to the desired Speakers On/Off setting.

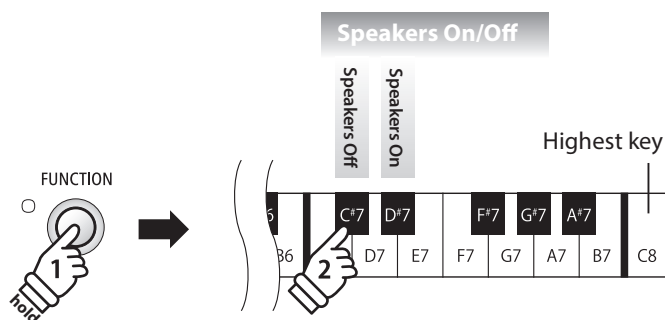

* Any changes made to the Speakers On/Off setting will remain until the power is turned off.

* Preferred Speakers On/Off settings can be stored to the Startup Setting memory for automatic selection when the instrument is turned on. Please refer to page 49 for more information.

Other Settings

1 Auto Power Off

The ES110 digital piano features a power saving function that can be used to automatically turn off the instrument after a specified period of inactivity.

* This setting will be stored automatically, and recalled every time the instrument is turned on.

■ Auto Power Off settings

Auto Power Off	Explanation	Key
Off	The Auto Power Off function is disabled.	G7
30 min.	The instrument will turn off automatically after 30 minutes of inactivity.	A7
60 min.	The instrument will turn off automatically after 60 minutes of inactivity.	B7
120 min.	The instrument will turn off automatically after 120 minutes of inactivity.	C8

■ Selecting the Auto Power Off setting

Press and hold the FUNCTION button, then press the key assigned to the desired Auto Power Off setting.

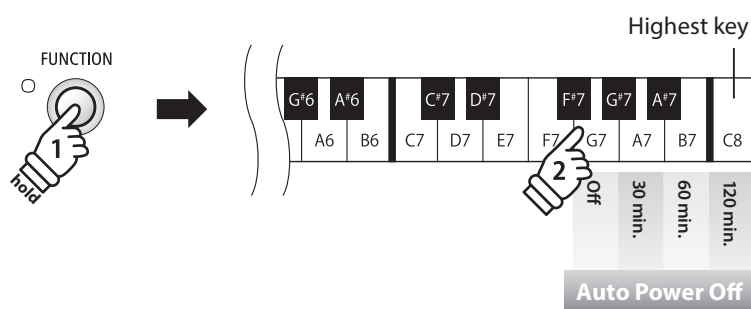

* The Auto Power Off setting will be stored automatically, and recalled when the instrument is turned on.

2 Bluetooth® MIDI

The Bluetooth MIDI setting is used to enable/disable the ES110 digital piano's Bluetooth MIDI function. When enabled, the ES110 digital piano can be connected to smart phones, tablets, and other smart devices to facilitate wireless MIDI communication, allowing a wide range of music-related apps to be enjoyed using the instrument.

* Availability of Bluetooth function dependent on market location.

■ Bluetooth MIDI settings

Bluetooth MIDI	Explanation	Key
Off	Disables the instrument's Bluetooth MIDI function.	G#5
On (default)	Enables the instrument's Bluetooth MIDI function.	A#5

■ Changing the Bluetooth MIDI setting

Press and hold the FUNCTION button, then press the key assigned to the desired Bluetooth MIDI setting.

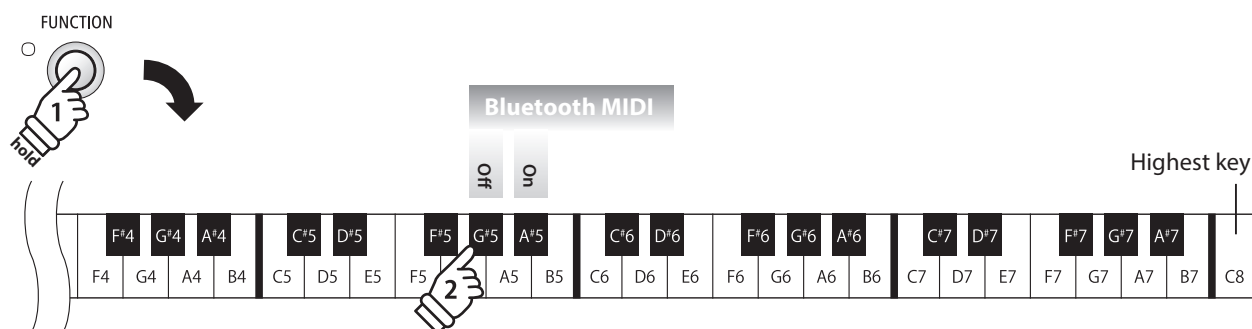

* Any changes made to the Bluetooth MIDI setting will remain until the power is turned off.

■ Connecting the ES110 digital piano to a smart device using Bluetooth MIDI

After enabling the Bluetooth MIDI function of the ES110 digital piano, enable Bluetooth communications on the smart device. After a few moments the ES110 should appear in the device list. Tap the ES110 entry to connect the instrument to the smart device. It should now be possible for MIDI apps to communicate with the ES110 digital piano.

- * When the ES110 digital piano is connected to a smart device via Bluetooth MIDI, the MIDI IN/OUT connectors will be disabled.
- * Please check for Bluetooth MIDI compatibility with the smart device manufacturer and app developer.
- * For a list of potential issues and recommended solutions when using Bluetooth communications, please refer to page 52 of this owner's manual.
- * For more detailed instructions regarding Bluetooth pairing, please refer to the supplementary *Bluetooth® Connectivity Guide* PDF manual, available from the Kawai Japan website: <http://www.kawai-global.com/support/manual/>

Memory Functions

1 Startup Setting

The Startup Setting function allows preferred panel settings to be stored in the instrument's memory, and automatically recalled as the default settings every time the ES110 digital piano is turned on.

■ Settings stored in Startup Setting memory

General	Settings
Selected sound	Keyboard and Sound Settings *
Dual Mode / Split Mode (Sounds, Volume balance)	MIDI Settings
Metronome (Beat, Tempo, Volume)	Speaker Settings
	Other Settings

- * The Transpose setting will not be stored to Startup Setting memory.
- * The Auto Power Off setting will be stored to Startup Setting memory automatically.

■ Storing current settings to Startup Setting memory

Press and hold the FUNCTION button, then press the key assigned to the Startup Setting function.

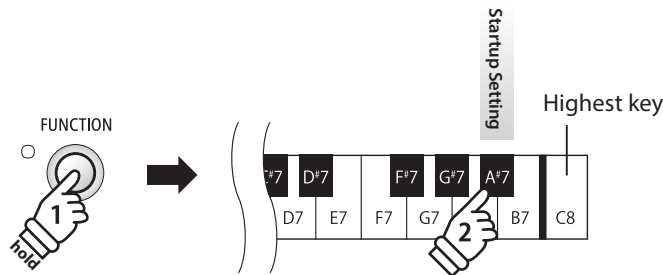

2 Factory Reset

The Factory Reset function clears any settings stored using the Startup Setting function, restoring the ES110 digital piano back to its factory default settings.

- * This function does not clear Registration memories or recorder songs stored in internal memory.

■ Restoring factory settings

Press and hold the FUNCTION button, then press the key assigned to the Factory Reset function.

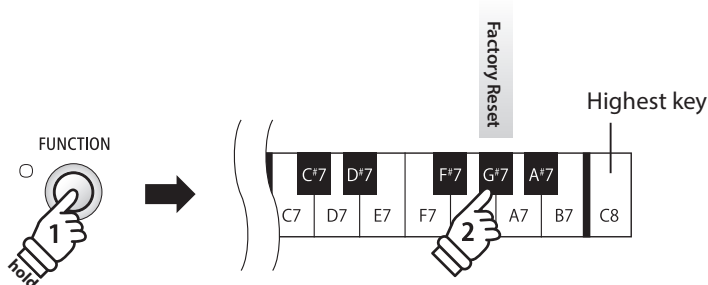

Connecting to Other Devices

The rear side of the ES110 digital piano features a variety of jacks that allow the instrument be connected to MIDI devices, computers, speakers, and mixers. The illustration below provides a visual overview of the instrument's connectors and typical applications.

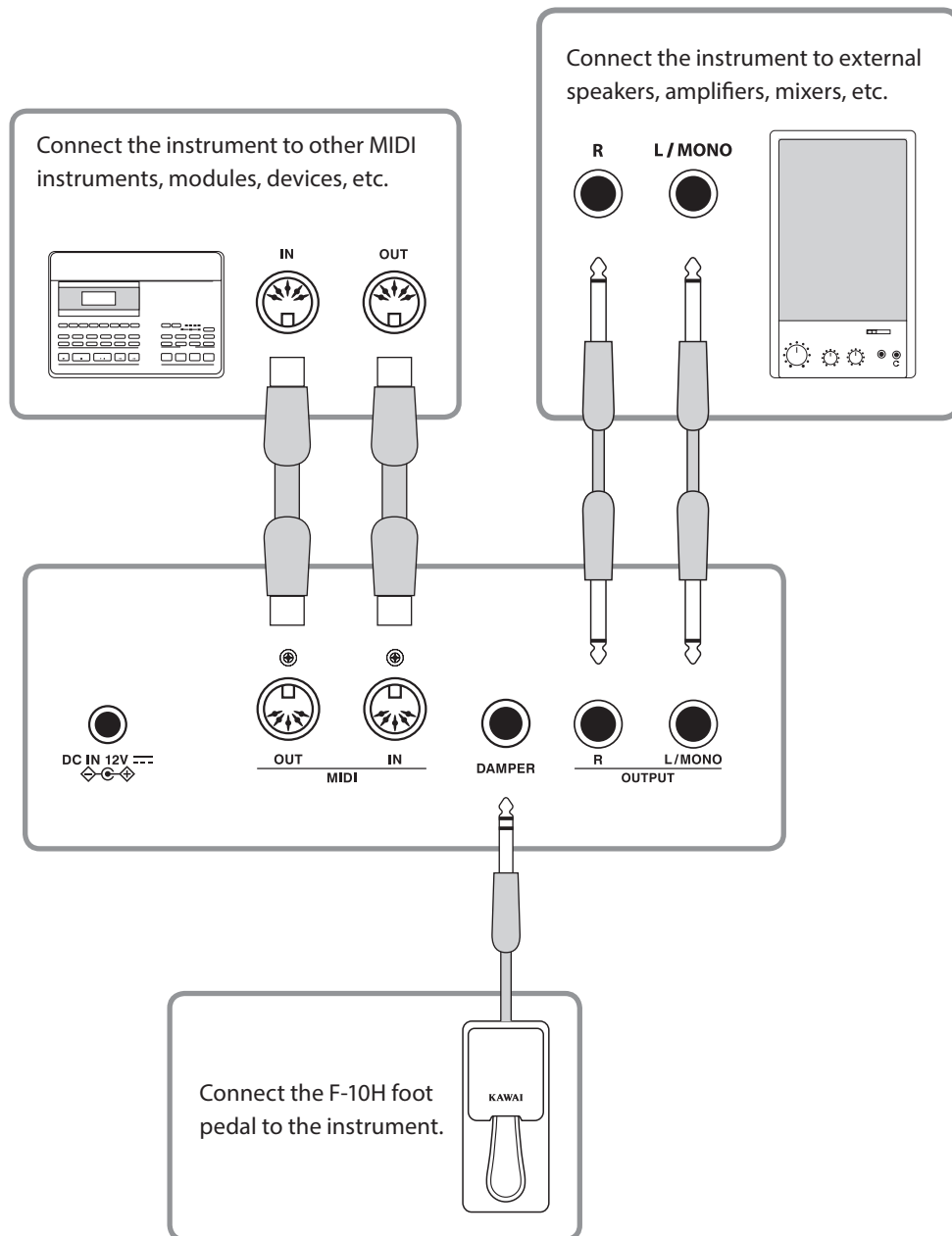

Before connecting the ES110 digital piano to other devices, ensure that the power to both the instrument and the other device is turned off. If connections are established while the power is turned on, extraneous noise that can damage the ES110 digital piano may activate the instrument's amplifier protection circuit, preventing any sound from being produced. If this occurs, turn the power off and then on again to reset the amplifier protection circuit.

Rear Connectors

■ DAMPER jack

This jack is used to connect the included F-10H foot pedal to the instrument.

* Please refer to page 11 for more information about pedal functions.

■ MIDI IN/OUT jacks

These jacks are used to connect the ES110 digital piano to external MIDI devices, and also to a computer with a MIDI interface.

* When the ES110 digital piano is connected to a smart device via Bluetooth MIDI, the MIDI IN/OUT connectors will be disabled.

* Please refer to page 39 for more information about MIDI.

■ LINE OUT jacks (1/4" phone jacks)

These jacks are used to connect the stereo output of the instrument's sound to external speakers, amplifiers, mixers, recording devices, and similar equipment. Mono signals will be output only if a cable is connected to the L/MONO jack. The MASTER VOLUME slider will affect the output level of the LINE OUT jacks.

* When using the LINE OUT jacks, it may also be desirable to disable both the instrument's built-in speakers and speaker EQ to ensure optimum sound quality.

* Please refer to pages 45 and 46 for more information about the Speakers On/Off and Speaker EQ settings.

Front Connectors

■ PHONES jacks (1/4" phone jack)

These jacks are used to connect stereo headphones to the ES110 digital piano. Two pairs of headphones can be connected and used simultaneously. When a pair of headphones is connected, sound will not be produced by the built-in speakers.

The built-in speaker can also be disabled by using the Speakers On/Off setting.

* Please refer to page 46 for more information about the Speakers On/Off setting.

Troubleshooting

The table below summarises issues that may be experienced with the ES110 digital piano, explaining the typical cause(s), and recommended solution(s).

	Issue	Possible Cause and Solution	Page no.	
Power	The instrument does not turn on.	Check that the AC power adaptor is firmly attached to the instrument, and connected to an AC outlet.	p. 12	
	The instrument turns itself off after a period of inactivity.	Check that the 'Auto Power Off' setting is not enabled.	p. 47	
Sound	The instrument is turned on, however no sound is produced when the keys are pressed.	Check that the MASTER VOLUME slider is not set to the lowest position.	p. 12	
		Check that a pair of headphones (or headphone adaptor plug) are not connected to the PHONES jacks.	p. 11	
		Check that the Local Control setting in the MIDI Settings menu is set to On.	p. 43	
		Check that the built-in speakers have not been disabled using the Speakers On/Off setting.	p. 46	
Sound	The sound distorts when playing at very loud volume levels.	Check that the MASTER VOLUME slider is set to an appropriate level, reducing the volume if excessive distortion is heard.	p. 12	
	Strange sounds or noises are heard when playing with piano sounds.	The ES110 digital piano attempts to reproduce the rich variety of tones created by an acoustic grand piano as accurately as possible. This includes damper resonances, damper noises, and other subtle characteristics that contribute to the overall piano playing experience.	p. 26	
		While these additional tones are intended to enhance the realism of the instrument, it is possible to reduce their prominence.		
MIDI	The top 18 notes of the keyboard sustain far longer than neighbouring notes, even when the damper pedal is not pressed.	This is the correct behaviour, and intended to reproduce the undamped notes (typically the top two octaves) of an acoustic grand piano.	–	
		MIDI data is not sent/received by the MIDI IN/OUT jacks.	Check that the MIDI channel is set correctly.	p. 42
		Check that the MIDI IN/OUT jacks are connected correctly.	p. 48	
Check that the ES110 digital piano is not connected to a smart device using Bluetooth MIDI.				
Bluetooth MIDI	The instrument cannot connect with the smart device/app.	<p>Ensure that the instrument's Bluetooth MIDI function is turned On.</p> <p>Ensure that the smart device/app's Bluetooth function is turned On.</p> <p>Try deleting the instrument's Bluetooth connection using the smart device's 'Forget Device' function.</p> <p>Try turning the instrument Off and then On, and/or restarting the smart device.</p> <p>* Please check for Bluetooth MIDI compatibility with the smart device manufacturer and app developer.</p>	p. 48	

Settings List

The table below lists settings/functions that can be adjusted from the ES110 digital piano's panel interface, in addition to available ranges/types, default settings, and Registration/Startup Setting storing capabilities.

Setting Name	Range / Type	Default Setting	Registration	Startup Setting
Normal Mode				
Sound	n/a	Concert Grand	●	●
Dual Mode				
Sound combination	n/a	n/a	●	–
Volume balance	0~8	4	●	●
Split Mode				
Sound combination	n/a	n/a	●	–
Volume balance	0~8	4	●	●
Metronome				
Time signature / Beat	1/4, 2/4, 3/4, 4/4, 5/4, 3/8, 6/8, Drum Rhythm	4/4	●	●
Volume	1~10	5	●	●
Tempo	10~300 bpm	120 bpm	●	●
Keyboard and Sound Settings				
Reverb	Off, Room, Small Hall, Concert Hall	Room	●	●
Damper Resonance	Off, Small, Medium, Large	Medium	●	●
Voicing	Normal, Mellow, Dynamic, Bright	Normal	●	●
Fall-back Noise	Off, Small, Normal, Large	Normal	●	●
Damper Noise	Off, Small, Normal, Large	Normal	●	●
Transpose	+/- 12 semi-tones	0	–	–
Brilliance	Off, -10~+10	Off	●	●
Touch	Off, Light, Normal, Heavy	Normal	●	●
Tuning	427~453 Hz	440.0 Hz	●	●
Temperament	Equal, Pure Major, Pure Minor, Pythagorean, Meantone, Werchmeister, Kimberger	Equal	●	●
Temperament Key	C~B	C	●	●
Effect On/Off	Off, On	See page 38	●	●
MIDI Settings				
Transmit PGM Change No.	Off, On	On	–	●
MIDI Channel	1ch~16ch	1ch	–	●
Local Control	Off, On	On	–	●
Multi-timbral Mode	Off, On	Off	–	●
Speaker Settings				
Speaker EQ	Normal, Table, Off	Normal	●	●
Speakers On/Off	Off, On	On	–	●
Other Settings				
Auto Power Off	Off, 30 min., 60 min., 120 min.	Off / 30min.*	–	●**
Bluetooth On/Off *	Off, On	Off	–	–
Memory Functions				
Startup Setting	n/a	n/a	–	–
Factory Reset	n/a	n/a	–	–

* Dependent on market location.

** Auto Power Off setting is stored to Startup Setting memory automatically.

Demo Song Lists

Key	Sound name	Song name	Composer
A0	Concert Grand	Suite Bergamasque I. Prélude	C. Debussy
B0	Concert Grand 2	Petit Chien	F. F. Chopin
C1	Studio Grand	Original	Kawai
D1	Mellow Grand	Sonata No.30 Op.109	L. v. Beethoven
E1	Classic E.Piano	Original	Kawai
F1	Modern E.Piano	Original	Kawai
G1	Jazz Organ	Original	Kawai
A1	Church Organ	Chorale Prelude "Wachet auf, ruft uns die Stimme"	J. S. Bach
B1	Slow Strings	Original	Kawai
C2	Electric Bass	Original	Kawai
D2	Harpsichord	French Suite No. 6	J. S. Bach
E2	Vibraphone	Original	Kawai

Drum Rhythm List

No.	Rhythm Name
1	8 Beat 1
2	8 Beat 2
3	8 Beat 3
4	16 Beat 1
5	16 Beat 2
6	16 Beat 3
7	16 Beat 4
8	16 Beat 5
9	16 Beat 6
10	Rock Beat 1
11	Rock Beat 2
12	Rock Beat 3
13	Hard Rock
14	Heavy Beat
15	Surf Rock
16	2nd Line
17	50 Ways
18	Ballad 1
19	Ballad 2
20	Ballad 3
21	Ballad 4
22	Ballad 5
23	Light Ride 1
24	Light Ride 2
25	Smooth Beat
26	Rim Beat
27	Slow Jam
28	Pop 1
29	Pop 2
30	Electro Pop 1
31	Electro Pop 2
32	Ride Beat 1
33	Ride Beat 2
34	Ride Beat 3
35	Ride Beat 4
36	Slip Beat
37	Jazz Rock
38	Funky Beat 1
39	Funky Beat 2
40	Funky Beat 3
41	Funk 1
42	Funk 2
43	Funk 3
44	Funk Shuffle 1
45	Funk Shuffle 2
46	Buzz Beat
47	Disco 1
48	Disco 2
49	Hip Hop 1
50	Hip Hop 2

No.	Rhythm Name
51	Hip Hop 3
52	Hip Hop 4
53	Techno 1
54	Techno 2
55	Techno 3
56	Heavy Techno
57	8 Shuffle 1
58	8 Shuffle 2
59	8 Shuffle 3
60	Boogie
61	16 Shuffle 1
62	16 Shuffle 2
63	16 Shuffle 3
64	T Shuffle
65	Triplet 1
66	Triplet 2
67	Triplet 3
68	Triplet 4
69	Triplet Ballad 1
70	Triplet Ballad 2
71	Triplet Ballad 3
72	Motown 1
73	Motown 2
74	Ride Swing
75	H.H. Swing
76	Jazz Waltz 1
77	Jazz Waltz 2
78	5/4 Swing
79	Fast 4 Beat
80	H.H. Bossa Nova
81	Ride Bossa Nova
82	Beguine
83	Mambo
84	Cha Cha
85	Samba
86	Light Samba
87	Surdo Samba
88	Latin Groove
89	Afro Cuban
90	Songo
91	Bembe
92	Merenge
93	Reggae
94	Tango
95	Habanera
96	Waltz
97	Ragtime
98	Country & Western
99	March
100	6/8 March

Lesson Function Song Lists

Alfred's Basic Piano Library Lesson Book Level 1A

A0	Right & Left
B0	Left & Right
C1	Merrily We Roll Along/O'er the Deep Blue Sea
D1	Hand-Bells
E1	Jolly Old Saint Nicholas
F1	Old MacDonald
G1	Batter Up!
A1	My Clever Pup
B1	The Zoo
C2	Playing in a New Position
D2	Sailing
E2	Skating
F2	Wishing Well
G2	Rain, Rain!
A2	A Happy Song
B2	Position C
C3	A Happy Song
D3	See-Saws
E3	Just a Second!
F3	Balloons
G3	Who's on Third?
A3	Mexican Hat Dance
B3	Rock Song
C4	Rockets
D4	Sea Divers
E4	Play a Fourth
F4	July the Fourth!
G4	Old Uncle Bill
A4	Love Somebody
B4	My Fifth
C5	The Donkey
D5	Position G
E5	Jingle Bells!
F5	Willie & Tillie
G5	A Friend Like You
A5	My Robot
B5	Rockin' Tune
C6	Indian Song
D6	Raindrops
E6	It's Halloween!
F6	Horse Sense

Alfred's Basic Piano Library Lesson Book Level 1B

A0	Step Right Up!
B0	The Carousel
C1	Hail to Thee, America!
D1	Brother John
E1	Good Sounds
F1	The Cuckoo
G1	Money Can't Buy Ev'rything!
A1	Ping-Pong
B1	Grandpa's Clock
C2	When the Saints Go Marching In
D2	G's in the "BAG"
E2	Join the Fun
F2	Oom-Pa-pa!
G2	The Clown
A2	Thumbs on C!
B2	Waltz Time
C3	Good King Wenceslas
D3	The Rainbow
E3	Good Morning to You!
F3	Happy Birthday to You!
G3	Yankee Doodle
A3	The Windmill
B3	Indians
C4	New Position G
D4	Pedal Play
E4	Harp Song
F4	Concert Time
G4	Music Box Rock
A4	A Cowboy's Song
B4	The Magic Man
C5	The Greatest Show on Earth!
D5	The Whirlwind
E5	The Planets
F5	C Major Scale Piece
G5	G Major Scale Piece
A5	Carol in G Major
B5	The Same Carol in C Major
C6	French Lullaby
D6	Sonatina
E6	When Our Band Goes Marching By!

Burgmüller 25 (25 Etudes Faciles, Opus 100)

A0	La candeur
B0	Arabesque
C1	Pastorale
D1	Petite réunion
E1	Innocence
F1	Progrès
G1	Courant Limpide
A1	La gracieuse
B1	La chasse
C2	Tendre fleur
D2	La bergeronnette
E2	Adieu
F2	Consolation
G2	La styrienne
A2	Ballade
B2	Douce plainte
C3	Babillarde
D3	Inquiétude
E3	Ave Maria
F3	Tarentelle
G3	Harmonie des anges
A3	Barcarolle
B3	Retour
C4	L'hirondelle
D4	La chevaleresque

■ Lesson Function song book availability

Alfred's Basic Piano Library, Burgmüller: *Etudes Faciles*, lesson song books are sold separately.

Please check your local dealer for more information. Alfred's international offices may also be contacted directly:

USA / Canada

Alfred Music Publishing
PO Box 10003
Van Nuys, CA 91410
Tel: +1 (800) 292-6122
Email: sales@alfred.com
Website: <http://www.alfred.com>

Australia

Alfred Publishing Australia
PO Box 2355
Taren Point NSW 2229
Tel: +61 (02) 9524 0033
Email: sales@alfredpub.com.au

Specifications

■ Kawai ES110 digital piano

Keyboard	88 weighted keys Responsive Hammer Compact (RHC) weighted-key keyboard action			
Sound Source	Harmonic Imaging™ (HI), 88-key piano sampling			
Internal Sounds	19 voices	PIANO	E.PIANO / ORGAN	OTHERS
		Concert Grand Concert Grand 2 Studio Grand Studio Grand 2 Mellow Grand Mellow Grand 2 Modern Piano Rock Piano	Classic E.Piano 60's E.Piano Modern E.Piano Jazz Organ Church Organ	Slow Strings String Ensemble Wood Bass Electric Bass Harpsichord Vibraphone
Polyphony	max. 192 notes			
Keyboard Modes	Dual Mode, Split Mode			
Reverb	Room, Small Hall, Concert Hall			
Settings	Touch Curve, Voicing, Damper Resonance, Damper Noise, Fall-back Noise, Temperament, Temperament Key, Effect On/Off			
Internal Recorder	3 song, recorder – approximately 15,000 note memory capacity			
Metronome	1/4, 2/4, 3/4, 4/4, 5/4, 3/8, 6/8 (Volume/Tempo adjustable)			
Rhythm	100 rhythms			
Demo Songs	12 sound demo songs			
Other Functions	Transpose, Tuning, Split Balance, Dual Balance, MIDI Channel, Local Control, Transmit PGM#, Multi-timbral Mode, Speaker EQ, Speakers On/Off, Auto Power Off, Bluetooth MIDI, Startup Setting, Factory Reset			
Bluetooth	Bluetooth (Ver. 4.0; GATT compatible) Bluetooth Low Energy MIDI Specification compliant			
Connectors	MIDI (IN/OUT), LINE OUT (L/MONO, R), DAMPER (for F-10H), Headphones x 2			
Speaker System	Speakers:	12 cm x 2		
	Output Power:	7 W x 2		
Power Consumption	9 W			
Dimensions	1312 (W) x 286 (D) x 148 (H) mm			
Weight	12.0 kg			
Finish	Black, White			

Specifications are subject to change without notice.

MIDI Implementation Chart

■ Kawai ES110 digital piano

Date : July 2016 Version : 1.0

Function	Transmit	Receive	Remarks	
Basic channel	At power-up Settable	1 1 - 16	1 1 - 16	
Mode	At power-up Message Alternative	Mode 3 X *****	Mode 1 Mode 1, 3** X	** Omni mode is on at power-up. Omni mode can be turned off through MIDI channel setting operations.
Note number	Range	9 - 120* *****	0 - 127 0 - 127	* 9 - 120, including transpose
Velocity	Note on Note off	0 0	0 0	
After touch	Key specific Channel specific	X X	X X	
Pitch bend		X	X	
Control change	0, 32 7 64 66 67	0 X 0 (Right pedal) 0 (Middle pedal) 0 (Left pedal)	0 0 0 0 0	Bank select Volume Sustain pedal Sostenuto pedal Soft pedal
Program change settable range		0 (0 - 127) *****	0 (0 - 127)	
Exclusive		0	0	Transmission can be selected
Common	Song position Song select Tune	X X X	X X X	
Real time	Clock Commands	X X	X X	
Other functions	Local On / Off All notes Off Active sensing Reset	X X X X	0 0 0 X	
Remarks				

Mode 1: omni mode On, Poly Mode 2: omni mode On, Mono
Mode 3: omni mode Off, Poly Mode 4: omni mode Off, Mono

O : Yes
X : No

SOUND SELECT

PIANO  +

Dual / Split Balance

Dual **Split** **+** **-**

A0	B0	C1	D1	E1	F1	G1	A1	B1
A0	B0	C1	D1	E1	F1	G1	A1	B1

Rock Piano
Modern Piano
Mellow Grand 2
Mellow Grand
Studio Grand 2
Studio Grand
Concert Grand 2
Concert Grand

Sound Select

E.PIANO / ORGAN  +

Dual / Split Balance

Dual **Split** **+** **-**

A0	B0	C1	D1	E1	F1	G1	A1	B1
A0	B0	C1	D1	E1	F1	G1	A1	B1

Church Organ
Jazz Organ
Modern E.Piano
60's E.Piano
Classic E.Piano

Sound Select

OTHERS  +

Dual / Split Balance



Dual **Split** **+** **-**

A0	B0	C1	D1	E1	F1	G1	A1	B1
A0	B0	C1	D1	E1	F1	G1	A1	B1

Vibraphone
Harpischord
Electric Bass
Wood Bass
String Ensemble
Slow Strings

Sound Select

SOUND EDIT

PIANO  **or** **E.PIANO / ORGAN**  **or** **OTHERS**  +

Dual / Split Balance

Split **+** **-**

A0	B0	C1	D1	E1	F1	G1	A1	B1
A0	B0	C1	D1	E1	F1	G1	A1	B1

Effect

Off On

Tuning

440.0 Hz +0.5 Hz -0.5 Hz

Touch

Off Normal Light Heavy

Brightness

Off + -

Transpose

Off + -

Dual / Split Balance

Split **+** **-**

A0	B0	C1	D1	E1	F1	G1	A1	B1
A0	B0	C1	D1	E1	F1	G1	A1	B1

Effect

Off On

Tuning

440.0 Hz +0.5 Hz -0.5 Hz

Touch

Off Normal Small Large

Brightness

Off Large Medium Small

Transpose

Off + -

Concert Hall
Small Hall
Room

Temperament

Temperament Key

C D E F G A B

Kimberger
Werkmeister
Meantone
Pythagorean
Pure Minor
Pure Major
Equal

Damper Noise
(For piano sound only)

Off Large Small Normal

Fall-back Noise
(For piano sound only)

Off Large Small Normal

Voicing
(For piano sound only)

Off Dynamic Mellow Normal

Damper Resonance
(For piano sound only)



Off Large Medium Small

Reverb

Off Concert Hall Small Hall Room

Sound Select

METRONOME

LESSON  + **PIANO**  + **METRONOME** 

Time Signature

1/4 2/4 3/4 4/4 5/4 3/8 6/8

Tempo + **Tempo -**

A0	B0	C1	D1	E1	F1	G1	A1	B1
A0	B0	C1	D1	E1	F1	G1	A1	B1

Metronome Volume

1 2 3 4 5 6 7 8 9 10

Metronome Tempo (2 or 3 digits)

1 2 3 4 5 6 7 8 9 0

Rhythm + **Rhythm -**

1 2 3 4 5 6 7 8 9 0

Rhythm Selection (2 or 3 digits)

KAWAI

THE FUTURE OF THE PIANO

