

KAWAI

NOVUS

NV10

Owner's Manual

Introduction

Playing the Piano

Recorder

Music Screen

Favorite Screen

Settings

Appendix

EN

Thank you for purchasing this Kawai *NOVUS* NV10 hybrid digital piano.

This owner's manual contains important information regarding the instrument's usage and operation.

Please read all sections carefully, keeping this manual handy for future reference.

■ About this Owner's Manual

Before attempting to play this instrument, please read the **Introduction** section (page 10) of this owner's manual. This section explains the name and function of each part, how to connect the power cable, and how to turn on the power.

The **Playing the Piano** section (page 22) provides an overview of the instrument's commonly used functions, allowing the NV10 hybrid digital piano to be enjoyed almost immediately after being connected, while the **Recorder** section (page 39) provides instructions on how to record pieces both to the instrument's internal memory, and to a USB memory device.

The **Music Screen** section (page 52) includes information regarding the built-in demonstration songs, Piano Music pieces, Lesson and Finger Exercise features, and Concert Magic function. This section also explains how to playback songs recorded to internal memory, or stored on a USB memory device.

The **Favorite Screen** section (page 80) provides instructions on how to store, select, and manage favourite sounds, while the **Settings** section (page 88) details the various options and settings that can be used to adjust the sound and operation of the instrument.

Finally, the **Appendix** section (page 149) includes lists for all internal sounds, songs, and drum rhythms, assembly instructions for the NV10 model, MIDI reference information, and full specification details.

Important Safety Instructions

SAVE THESE INSTRUCTIONS

INSTRUCTIONS PERTAINING TO A RISK OF FIRE, ELECTRIC SHOCK, OR INJURY TO PERSONS



WARNING

TO REDUCE THE RISK OF FIRE OR ELECTRIC SHOCK, DO NOT EXPOSE THIS PRODUCT TO RAIN OR MOISTURE.

AVIS : RISQUE DE CHOC ELECTRIQUE - NE PAS OUVRIR.

TO REDUCE THE RISK OF ELECTRIC SHOCK, DO NOT REMOVE COVER (OR BACK). NO USER-SERVICEABLE PARTS INSIDE. REFER SERVICING TO QUALIFIED SERVICE PERSONNEL.



The lightning flash with arrowhead symbol, within an equilateral triangle, is intended to alert the user to the presence of uninsulated "dangerous voltage" within the product's enclosure that may be of sufficient magnitude to constitute a risk of electric shock to persons.



The exclamation point within an equilateral triangle is intended to alert the user to the presence of important operating and maintenance (servicing) instructions in the literature accompanying the product.

Examples of Picture Symbols



denotes that care should be taken.
The example instructs the user to take care not to allow fingers to be trapped.



denotes a prohibited operation.
The example instructs that disassembly of the product is prohibited.





denotes an operation that should be carried out.
The example instructs the user to remove the power cord plug from the AC outlet.

Read all the instructions before using the product.

- 1) Read these instructions.
- 2) Keep these instructions.
- 3) Heed all warnings.
- 4) Follow all instructions.
- 5) Do not use this apparatus near water.
- 6) Clean only with dry cloth.
- 7) Do not block any ventilation openings. Install in accordance with the manufacturer's instructions.
- 8) Do not install near any heat sources such as radiators, heat registers, stoves, or other apparatus (including amplifiers) that produce heat.
- 9) Do not defeat the safety purpose of the polarized or grounding-type plug. A polarized plug has two blades with one wider than the other. A grounding type plug has two blades and a third grounding prong. The wide blade or the third prong are provided for your safety. If the provided plug does not fit into your outlet, consult an electrician for replacement of the obsolete outlet.
- 10) Protect the power cord from being walked on or pinched particularly at plugs, convenience receptacles, and the point where they exit from the apparatus.
- 11) Only use attachments/accessories specified by the manufacturer.
- 12) Use only with the cart, stand, tripod, bracket, or table specified by the manufacturer, or sold with the apparatus. When a cart is used, use caution when moving the cart/apparatus combination to avoid injury from tip-over. 
- 13) Unplug this apparatus during lightning storms or when unused for long periods of time.
- 14) Refer all servicing to qualified service personnel. Servicing is required when the apparatus has been damaged in any way, such as power-supply cord or plug is damaged, liquid has been spilled or objects have fallen into the apparatus, the apparatus has been exposed to rain or moisture, does not operate normally, or has been dropped.

Règles de sécurité (Supplémentaires pour le Canada)

CONSERVEZ CES INSTRUCTIONS

	CAUTION RISK OF ELECTRIC SHOCK DO NOT OPEN		AVERTISSEMENT POUR REDUIRE LES RISQUES D'INCENDIE OU D'ELECTROCUTION, PROTEGEZ CET APPAREIL DE LA PLUIE OU DE L'HUMIDITE.
---	---	---	--

AVIS : RISQUE DE CHOC ELECTRIQUE - NE PAS OUVRIR.

POUR REDUIRE LES RISQUES D'INCENDIE OU D'ELECTROCUTION, NE DEMONTEZ PAS LE COUVERCLE (OU L'ARRIERE). A L'INTERIEUR, AUCUNE PARTIE N'EST REPARABLE PAR L'UTILISATEUR. POUR LA MAINTENANCE, ADRESSEZ-VOUS A DU PERSONNEL QUALIFIE.





Le symbole de l'éclair avec une pointe de flèche à l'intérieur d'un triangle équilatéral met en garde l'utilisateur contre la présence de tension dangereuse, non isolée, à l'intérieur de l'appareil, dont l'amplitude peut être suffisante pour induire un risque d'électrocution d'une personne.



Le point d'exclamation à l'intérieur d'un triangle équilatéral alerte l'utilisateur de la présence de règles d'utilisation et d'entretien importantes dans la notice qui accompagne l'appareil.

Exemples de symboles graphiques

	Indique que des précautions doivent être prises. L'exemple indique à l'utilisateur qu'il doit faire attention à ne pas se faire coincer les doigts.
	Indique une manipulation interdite. L'exemple indique que le démontage de l'appareil est interdit.
	Indique qu'une manipulation doit être effectuée. L'exemple indique à l'utilisateur qu'il doit débrancher le câble d'alimentation de la prise secteur.



AVERTISSEMENT

Indique un risque potentiel qui peut entraîner la mort, ou de graves lésions, si l'appareil n'est pas manipulé correctement.

Faite attention de ne pas introduire un produit étranger à l'intérieur de l'appareil.

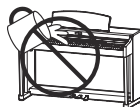

L'introduction d'eau, d'aiguilles ou d'épingles à cheveux, peut provoquer une panne ou un court-circuit. Ce produit doit être mis à l'abri des écoulements ou projections d'eau. Ne jamais placer sur le produit des objets contenant des liquides, tels que des vases ou autres récipients.

Ce produit n'est pas totalement déconnecté du circuit électrique lorsqu'il est mis hors tension par le bouton d'arrêt. Si l'appareil ne doit pas être utilisé pendant une longue période, débranchez le câble d'alimentation de la prise secteur.



- Si vous ne le faisiez pas la foudre pourrait provoquer un incendie.
- Si vous ne le faisiez pas, la surchauffe de l'appareil pourrait provoquer un incendie.

Il est recommandé de placer l'instrument à proximité de la prise de courant et de positionner le câble d'alimentation secteur de sorte qu'il puisse être débranché rapidement en cas d'urgence, le courant électrique étant toujours présent tant que la prise est branchée même si le bouton de mise en marche est en position Arrêt.

[Seuls les produits avec 3P fiche]

INSTRUCTIONS DE MISE À LA TERRE

Ce produit doit être mis à la terre. En cas de défaillance matérielle ou de panne, la mise à la terre fournit un chemin de moindre résistance au courant électrique afin de réduire le risque d'électrocution. Ce produit est équipé d'un câble avec un conducteur de protection et une fiche de mise à la terre. La fiche doit être branchée dans une prise appropriée correctement installée et mise à la terre conformément à tous les codes et règlements locaux.

DANGER - La connexion incorrecte du conducteur de protection peut présenter un risque d'électrocution.

Consultez un électricien ou un réparateur qualifié si vous avez des doutes en ce qui concerne la mise à la terre du produit. Ne modifiez pas la fiche fournie avec le produit – si elle n'est pas adaptée à la prise, faites installer une prise correcte par un électricien qualifié.



PRECAUTION

Indique un risque potentiel qui peut entraîner la détérioration, ou des dommages, pour l'appareil ou ses propriétés, si celui-ci n'est pas manipulé correctement.

Description de la l'emplacement de la référence (Le cas échéant):

Anglais phrase: The nameplate label is located on the underside of the instruments, as indicated below.

Français phrase: La référence commerciale est inscrite sur une étiquette en dessous de votre instrument, conformément à l'indication ci-dessous.

Votre piano doit être placé à un endroit tel que sa position n'altère pas sa propre ventilation. Gardez une distance minimum de 5 cm autour de l'instrument pour une aération suffisante.

WARNING - When using electric products, basic precautions should always be followed, including the following.



WARNING

Indicates a potential hazard that could result in death or serious injury if the product is handled incorrectly.

The product should be connected to an AC outlet of the specified voltage.

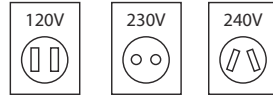

- If you are going to use an AC power cord, make sure that its has the correct plug shape and conforms to the specified power voltage.
- Failure to do so may result in fire.

Do not insert or disconnect the power cord plug with wet hands.



Doing so may cause electric shock.

Take care not to allow any foreign matter to enter the product.

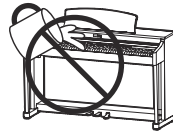

Entry of water, needles or hair pins may result in breakdown or short-circuit. The product shall not be exposed to dripping or splashing. No objects filled with liquids, such as vases, shall be placed on the product.

The chair must be used properly (it must be used only when playing the product).

- Do not play with it or stand on it.
- Only one person is allowed to sit on it.
- Do not sit on it when opening the lid.
- Re-tighten the bolts occasionally.

Doing so may cause the chair to fall over or your fingers to be trapped, resulting in injury.

When using the headphones, do not listen for long periods of time at high volume levels.

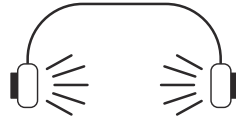

Doing so may result in hearing problems.

Do not lean against the keyboard.

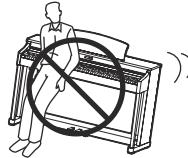

Doing so may cause the product to fall over, resulting in injury.

Do not disassemble, repair or modify the product.

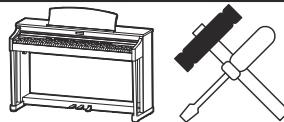

Doing so may result in product breakdown, electric shock or short-circuit.

When disconnecting the AC power cord's plug, always hold the plug and pull it to remove it.



- Pulling the AC power cord itself may damage the cord, causing a fire, electric shock or short-circuit.

The product is not completely disconnected from the power supply even when the power switch is turned off. If the product will not be used for a long time, unplug the AC power cord from the AC outlet.



- Failure to do so may cause fire in case of lightning.
- Failure to do so may over-heat the product, resulting in fire.

This product may be equipped with a polarized line plug (one blade wider than the other). This is a safety feature. If you are unable to insert the plug into the outlet, contact an electrician to replace your obsolete outlet. Do not defeat the safety purpose of the plug.

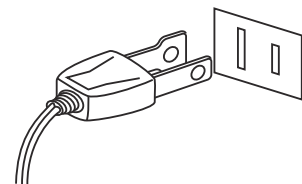

This product shall be near the AC outlet and the power cord plug in a position so that it can readily be disconnected in an emergency because electricity is always charging while the plug is in the AC outlet even in a power switch off condition.



CAUTION

Indicates a potential hazard that could result in injury or damage to the product or other property if the product is handled incorrectly.

Do not use the product in the following areas.

- Areas, such as those near windows, where the product is exposed to direct sunlight
- Extremely hot areas, such as near a heater
- Extremely cold areas, such as outside
- Extremely humid areas
- Areas where a large amount of sand or dust is present
- Areas where the product is exposed to excessive vibrations

Using the product in such areas may result in product breakdown. Use the product only in moderate climates (not in tropical climates).

When you close the keyboard cover, close it gently.

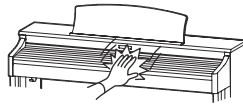

Closing it roughly may trap your fingers, resulting in injury.

Before connecting cords, make sure that the power to this product and other devices is turned OFF.

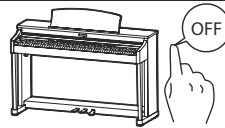

Failure to do so may cause breakdown of this product and other devices.

Do not drag the product on the floor. Take care not to drop the product.

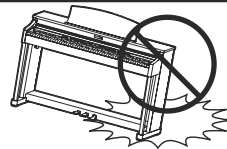

Please lift up the product when moving it. Please note that the product is heavy and must be carried by more than two persons. Dropping the product may result in breakdown.

Do not place the product near electrical appliances such as TVs and radios.

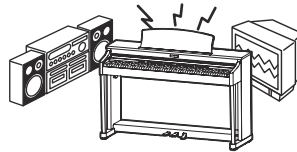

- Doing so may cause the product to generate noise.
- If the product generates noise, move the product sufficiently away from the electrical appliance or connect it to another AC outlet.

When connecting the AC power cord and other cords, take care not to get them tangled.



Failure to do so may damage them, resulting in fire, electric shock or short-circuit.

Do not wipe the product with benzene or thinner.



- Doing so may result in discoloration or deformation of the product.
- When cleaning the product, put a soft cloth in lukewarm water, squeeze it well, then wipe the product.

Do not stand on the product or exert excessive force.



- Doing so may cause the product to become deformed or fall over, resulting in breakdown or injury.

Do not place naked flame, such as lighted candles on the product.

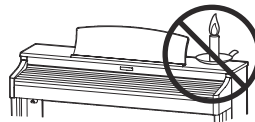

Doing so may cause the illumination to fall over, resulting in fire.

Ensure that the ventilation is not impeded by covering the ventilation openings with items, such as newspaper, table-cloths, curtains, etc.

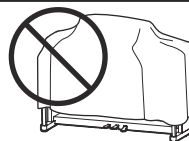

Failure to do so may over-heat the product, resulting in fire.

The product should be located so that its location or position does not interfere with its proper ventilation. Ensure a minimum distance of 5cm around the product for sufficient ventilation.

The product should be serviced by qualified service personnel when:

- The power supply cord or the plug has been damaged.
- Objects have fallen, or liquid has been spilled into the product.
- The product has been exposed to rain.
- The product does not appear to operate normally or exhibits a marked change in performance.
- The product has been dropped, or the enclosure damaged.

Notes on Repair

Should an abnormality occur in the product, immediately turn the power OFF, disconnect the power cord plug, and then contact the shop from which the product was purchased.

CAUTION:

To prevent electric shock, match wide blade of plug to wide slot, fully insert.

ATTENTION:

Pour éviter les chocs électriques, introduire la lame la plus large de la fiche dans la borne correspondante de la prise et pousser jusqu'au fond.



An information on Disposal for users

If your product is marked with this recycling symbol it means that, at the end of its life, you must dispose of it separately by taking it to an appropriate collection point.

You should not mix it with general household waste. Disposing of this product correctly will prevent potential negative effects on the environment and human health which could otherwise arise due to inappropriate waste handling.

For further details, please contact your local authority.
(European Union only)

Instruction for AC power cord (U.K.)

IMPORTANT

THE WIRES IN THIS MAINS LEAD ARE COLOURED IN ACCORDANCE WITH THE FOLLOWING CODE.

BLUE : NEUTRAL
BROWN : LIVE

As the colours of the wires in the mains lead of this apparatus may not correspond with the coloured markings identifying the terminals in your plug, proceed as follows:

The wire which is coloured BLUE must be connected to the terminal which is marked with the letter N or coloured BLACK.

The wire which is coloured BROWN must be connected to the terminal which is marked with the letter L or coloured RED.

Do not plug either terminal of the power cord to the the ground od AC outlet on the wall.

FCC Information (U.S.A)

CAUTION : Changes or modifications not expressly approved by the party responsible for compliance could void the user's authority to operate the equipment.

NOTE : This equipment has been tested and found to comply with the limits for a Class B digital device, pursuant to Part 15 of the FCC Rules. These limits are designed to provide reasonable protection against harmful interference in a residential installation. This equipment generates, uses and can radiate radio frequency energy and, if not installed and used in accordance with the instructions, may cause harmful interference to radio communications. However, there is no guarantee that interference will not occur in a particular installation. If this equipment does cause harmful interference to radio or television reception, which can be determined by turning the equipment off and on, the user is encouraged to try to correct the interference by one or more of the following measures:

- Reorient or relocate the receiving antenna.
- Increase the separation between the equipment and receiver.
- Connect the equipment into an outlet on a circuit different from that to which the receiver is connected.
- Consult the dealer or an experienced radio/TV technician for help.

Declaration of Conformity

Products :	Electronic Piano
Model Number :	NV10
Responsible Party Name :	Kawai America Corporation
Address :	2055 East University Drive Rancho Dominguez, CA 90220
Telephone	310-631-1771

This device complies with Part 15 of the FCC Rules.

Operation is subject to the following two conditions:

- (1) this device may not cause harmful interference, and
- (2) this device must accept any interference received, including interference that may cause undesired operation.

This applies only to products distributed by Kawai America Corporation.

The nameplate label is located on the underside of the instrument, as indicated below.

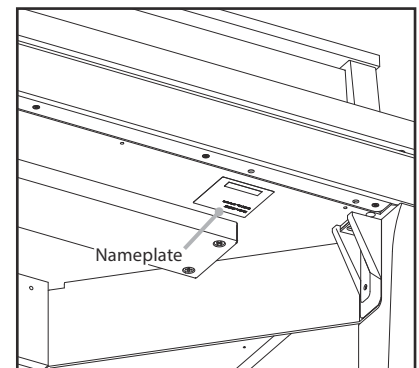

About Bluetooth

- The Bluetooth® word mark and logos are registered trademarks owned by the Bluetooth SIG, Inc. and any use of such marks by Kawai Musical Instruments Mfg. Co., Ltd. is under license. Other trademarks and trade names are those of their respective owners.
- Frequency Band of Radio: 2400~2483.5 MHz Maximum Transmit Power: 2.5 mW (BLE), 4.5mW (A2DP)
- Availability of Bluetooth function dependent on market location.



Table of Contents

Important Safety Instructions	3
Table of Contents	8

Introduction

Welcome to the NOVUS NV10	10
Feature Highlights	10
Part Names and Functions	12
Setting Up the Piano	14
1. Power	14
2. Key cover and music rest	15
3. Volume and headphones	16
4. Pedals	17
5. Touchscreen Operations	18
6. User Interface Overview	19

Playing the Piano

Pianist mode screen	22
1. Rendering character and Resonance depth ...	23
2. Pianist mode menu	24
Sound mode screen	26
1. Single	27
2. Dual	27
3. Split	29
4. 4Hands	31
5. Reverb	33
6. Effects	34
Metronome / Drum Patterns	36
Metronome settings	37
Drum rhythms	38

Recorder

About the Recorder	39
Song Recorder (Internal memory)	40
1. Recording a song: Pianist mode	40
2. Recording a song: Sound mode	43

Audio Recorder (USB memory)	49
1. Recording an audio file: Pianist and Sound mode	49

Music Screen

About the Music Screen	52
Demo Songs	53
Piano Music	55
Lesson Songs	57
Concert Magic	63
1. Concert Magic song playback	65
2. Concert Magic song performance	67
Recorder Playback	69
USB Memory Player	75

Favorite Screen

About the Favorite Screen	80
1. Storing and Selecting Favorite memories ...	82
2. Editing Favorite memories	84

Settings

About Settings	88
1. Pianist mode menu	88
2. Sound mode menu	92
Virtual Technician	98
1. Touch Curve	102
User Touch Curve	103
2. Voicing	104
User Voicing	105
3. Damper Resonance	106
4. Damper Noise	106
5. String Resonance	107
6. Undamped String Resonance	108
7. Cabinet Resonance	109
8. Key-off Effect	110
9. Fall-back Noise	111

10. Hammer Delay	112
11. Topboard Simulation	113
12. Decay Time	114
13. Minimum Touch	114
14. Stretch Tuning	115
User Tuning	116
15. Temperament	117
User Temperament	118
16. Temperament Key	119
17. Key Volume	120
User Key Volume	121
18. Half-Pedal Adjust	122
19. Soft Pedal Depth	122
Sound Settings	123
1. Tuning	124
2. Damper Hold	124
3. Tone Control	125
User Tone Control	126
4. Speaker Volume	127
5. Line In Level	128
6. Wall EQ	129
7. SHS Mode	130
8. Phones Type	131
9. Phones Volume	132
System Settings	133
1. Bluetooth® MIDI	134
2. Bluetooth® Audio	135
3. Bluetooth® Audio Level	136
4. Rename File	137
5. Delete File	138
6. USB Format	139
MIDI Overview	140
7. MIDI Channel	142
8. Send Program Change Number	143
9. Local Control	143
10. Transmit Program Change Numbers	144
11. Multi-timbral Mode	145
12. Channel Mute	145

13. LCD Contrast	146
14. Auto Display Off	146
15. Auto Power Off	147
16. Factory Reset	148

Appendix

Assembly Instructions	149
Connecting to Other Devices	154
Jack Panel	155
Headphone Panel	155
USB MIDI (USB to Host connector)	156
Troubleshooting	157
Demo Song List	160
Sound List (Sound mode)	161
Program Change Number List	162
Drum Rhythm List	170
Specifications	171
MIDI Exclusive Data Format	172
MIDI Implementation Chart	173

Welcome to the NOVUS NV10

Feature Highlights

Millennium III Hybrid grand piano keyboard action, with optical hammer sensing system

The NOVUS NV10 is the first digital piano to incorporate Kawai's leading acoustic grand piano keyboard action technology, renowned for its extended spruce key sticks, and innovative ABS Carbon components that are stronger, lighter, and more dimensionally stable than conventional wooden parts.

The specially adapted *Millennium III Hybrid* keyboard action utilised by the NV10 replaces traditional felt hammers with new ABS equivalents that are individual graded in weight from bass to treble, while high-precision optical sensors take the place of metal strings, accurately reading the subtle movements of each hammer as the corresponding keys are played.

Grand Piano Damper Mechanism for authentic pedal control

In addition to featuring a full acoustic grand piano keyboard action, the NOVUS NV10 is the first hybrid instrument to also incorporate a real grand piano damper mechanism. While there are no strings inside the NV10 to require physical damping, this unique feature replicates the true weighting of a grand piano damper pedal, while also mechanically easing the keyboard action's touch weight as the pedal is pressed.

Shigeru Kawai SK-EX concert grand piano reproduced with latest SK-EX Rendering sound technology

The magnificent tone of Kawai's flagship Shigeru Kawai *SK-EX* full concert grand piano is at the heart of the NOVUS NV10 hybrid digital piano. Widely regarded as the 'premier pianos of Japan', Shigeru Kawai instruments grace the stages of concert halls and musical institutions throughout the world, and are prized for their tonal clarity and exceptional dynamic range.

In order to faithfully reproduce the stunning sound of a Shigeru digitally, Kawai has developed *SK-EX Rendering* – a brand new piano sound engine that blends multi-channel, 88-key sampling with the latest resonance modelling technology. Multi-channel sampling captures the sound from different points of the Shigeru Kawai concert grand piano, allowing a broader range of tonal characteristics to be reproduced, and providing a more lively, authentic response to changes in dynamics. This naturally expressive sound is further enriched by newly developed resonance algorithms, which physically model the complex tonal interactions produced by the strings, pedals, and various other parts of an acoustic piano, giving players the impression that they're sitting at a living, breathing instrument.

Alternative acoustic piano sounds and a strong selection of additional instrument voices

In addition to the latest *SK-EX Rendering* piano sound engine, the NOVUS NV10 hybrid digital piano also incorporates Kawai's highly regarded *Harmonic Imaging XL* technology, showcasing a variety of alternative acoustic piano sounds and a strong selection of additional instrument voices. The Kawai EX full concert grand piano has frequently been selected by professional pianists in such prestigious events as the Chopin, Tchaikovsky, and Rubinstein international piano competitions, while the Shigeru Kawai SK-5 chamber grand and Kawai K-60 upright, allow performers to enjoy the contrasting tonal characteristics of various different piano sizes and voicing configurations.

Supplementing these realistic acoustic piano voices, the NOVUS NV10 hybrid digital piano also features an excellent selection of additional instrument sounds, ranging from electric pianos and drawbar and church organs, to strings, human choirs, and even atmospheric synth-style pads, inviting musicians to add greater variety to their performances. Furthermore, the *Dual* playing mode also allows two different sounds, such as grand piano and strings, to be layered together, while the *Split* and *4Hands* playing modes divide the keyboard into two independent sections.

Virtual Technician adjustments to personalise the instrument's character

The NOVUS NV10 hybrid digital piano's *Virtual Technician* feature allows various characteristics of the selected acoustic piano, electric piano, or harpsichord sound to be shaped from the instruments' touchscreen display, with settings to adjust voicing and regulation, string, damper, and cabinet resonances, and subtle hammer, damper, and key release noises. It is even possible to adjust the precise tuning and volume of individual notes, before storing one's favorite instrument configuration to memory.

Integrated Bluetooth® MIDI and Audio connectivity

In addition to standard MIDI jacks for connecting to other instruments, the NOVUS NV10 hybrid digital piano also boasts integrated *Bluetooth* MIDI and Audio technology that allows the instrument to communicate with supported smart devices wirelessly. Once connected to a phone, tablet, or laptop, NV10 owners can enjoy a wide variety of exciting music-related apps that enhance their learning and playing experience, or stream audio from songs and videos through the instrument's speakers without any additional cables.

* Availability of Bluetooth function dependent on market location.

USB to Device functionality, with MP3/WAV file recording and playback

The NOVUS NV10 hybrid digital piano is equipped with USB connectors that not only allow the instrument to be connected to a computer for MIDI use, but also to load and save data to USB memory devices directly. This '*USB to Device*' feature allows recorded songs stored in internal memory to be saved to USB for posterity, or standard MIDI files (SMF) downloaded from the internet to be conveniently played back without additional hardware.

USB memory devices can also be used to play back MP3 or WAV audio files, allowing musicians to learn the chords or melody for a new piece, or to simply play along with their favorite songs. It is even possible to save performances as MP3 or WAV files for emailing to friends and family, listening to on the move, or for further editing using an audio workstation.

Premium audio hardware, powered by Onkyo

Developed in collaboration with Onkyo, one of Japan's leading premium audio equipment manufacturers, the NOVUS NV10 hybrid digital piano is one of the first Kawai musical instruments to utilise specialist components designed for high-end audio reproduction.

With cutting-edge technologies such as 1-bit processing, dual DAC signal conversion, and Onkyo's DIRDC filtering, the NV10's optimised power amplifiers reproduce the Shigeru Kawai grand piano sound with stunning clarity, richness, and power, while the high-performance Discrete Spectra Module headphone amplifier ensures the finest quality listening experience, even when playing in privacy.

Full-colour touchscreen display for intuitive, button-less operation

The NOVUS NV10 is the first instrument of its kind to feature a full-colour 5" touchscreen display. Discreetly embedded within the left cheekblock, this high resolution touchscreen allows sounds and settings to be selected from an attractive user interface with the swipe of a finger. The display can also be set to turn off automatically while playing, thus preserving the NV10's acoustic piano-like appearance, and minimising any visual distraction to the pianist.

Part Names and Functions

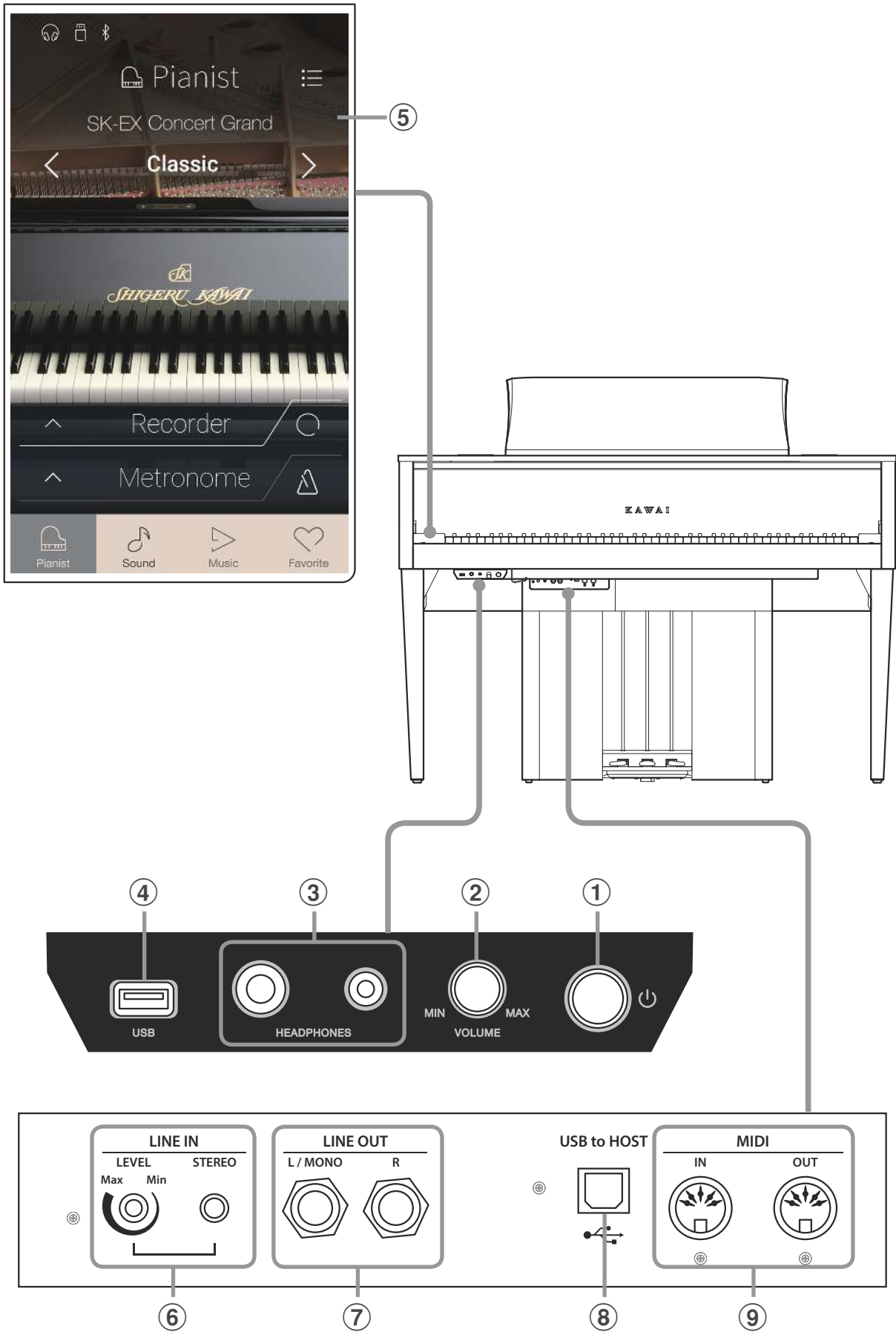

① POWER button

This button is used to turn the instrument on/off. Be sure to turn off the instrument after playing.

* The NV10 hybrid digital piano features a power saving mode that can turn off the instrument automatically after a specified period of inactivity. For more information, please refer to the 'Auto Power Off' setting on page 147.

② MASTER VOLUME knob

This knob controls the master volume level of the instrument's built-in speakers or headphones, if connected.

* The MASTER VOLUME knob will also affect the volume level of the LINE OUT connectors.

③ PHONES jacks

These jacks are used to connect stereo headphones to the NV10 hybrid digital piano. 1/4" and 1/8" connectors are provided for convenience, and both can be used simultaneously, allowing two pairs of headphones to be connected at the same time.

④ USB to DEVICE connector

This port is used to connect a FAT or FAT32 formatted USB memory device to the instrument in order to load/save recorded song data, and MP3/WAV/SMF files etc.

⑤ TOUCHSCREEN display

The touchscreen display provides useful information such as the currently selected mode, sound name, settings values, and the status of various functions. The touchscreen is also used to interact with the instrument by gently tapping on buttons and icons that appear, or by swiping left and right, or up and down.

* A protective plastic film is attached to the display during production. Please remove this film before attempting to play the instrument.

* The display can be set to turn off automatically after a period of inactivity. For more information, please refer to the 'Auto Display Off' setting on page 146.

⑥ LINE IN STEREO jack

This jack is used to connect the 1/8" stereo output from smart phones, tablets, computers, or other electronic audio equipment to the NV10 hybrid digital piano's amplifier and speakers.

The input level can be adjusted by using the LEVEL knob.

⑦ LINE OUT jacks

These jacks are used to connect the stereo output (Left/Right 1/4" phone plug) of the NV10 hybrid digital piano to external amplifiers, mixers, recording devices, and similar equipment.

⑧ USB to HOST port

This port is used to connect the NV10 hybrid digital piano to a computer using a USB 'B to A' type cable in order to send and receive MIDI data.

⑨ MIDI IN / OUT jacks

These jacks are used to connect the NV10 hybrid digital piano to external MIDI devices such as other musical instruments or a computer in order to send and receive MIDI data.

* For more information about the instrument's connectors and jacks, please refer to 'Connecting to Other Devices' on page 154.

Setting Up the Piano

1 Power

1. Connecting the power cable to the instrument

Connect the included power cable to the AC IN terminal located on the back side of the pedal base, in the bottom left corner.

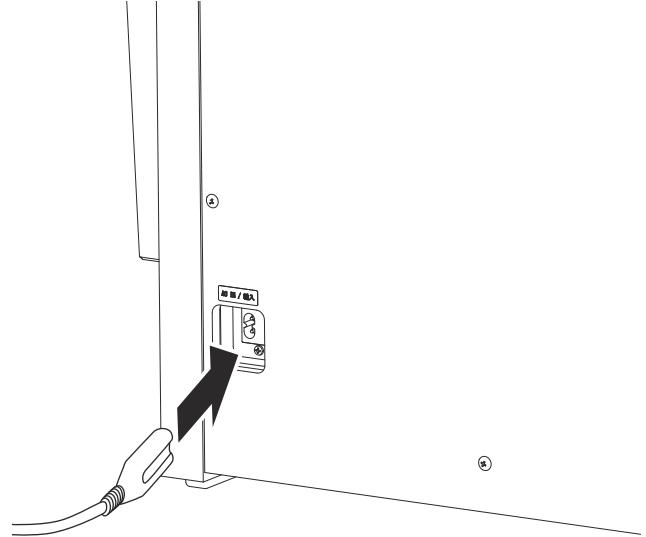

2. Connecting the power cable to an outlet

Connect the included power cable to the AC IN terminal located on the back side of the pedal base, in the bottom left corner.

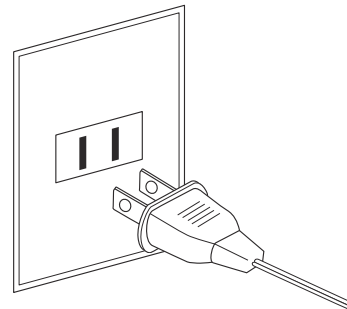

3. Turning on the power

Press the POWER button located on the right hand side of the control box.

The instrument will turn on and the KAWAI logo will appear in the touchscreen display. After a short period, the Pianist mode screen will appear, indicating that the instrument is ready to be played. To turn off the power, press and hold the POWER button again for 1~2 seconds.

* Please do not turn off the instrument while the initial KAWAI logo is displayed.

* The NV10 hybrid digital piano features a power saving mode that can turn off the instrument automatically after a specified period of inactivity. For more information, please refer to the 'Auto Power Off' setting on page 147.

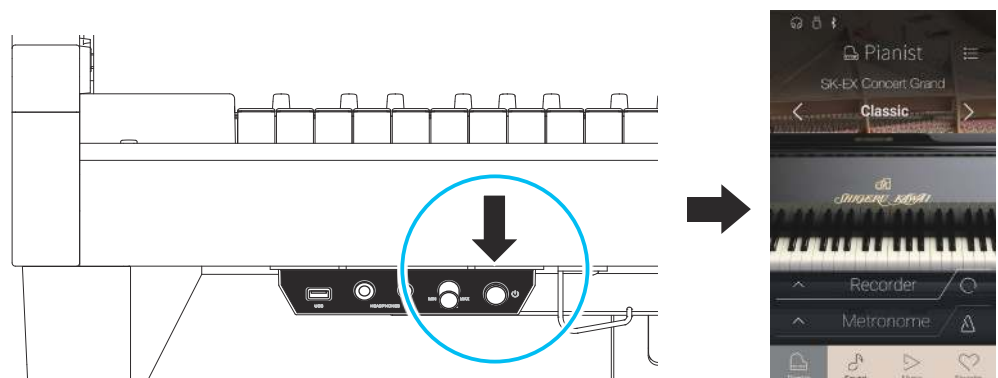

2 Key cover and music rest

■ Opening the key cover

Gently lift the key cover with both hands.

To close the key cover, slowly push or pull it forwards. The Soft Fall system will gently lower the key cover naturally.

* Please do not apply additional force on the key cover while it is closing.

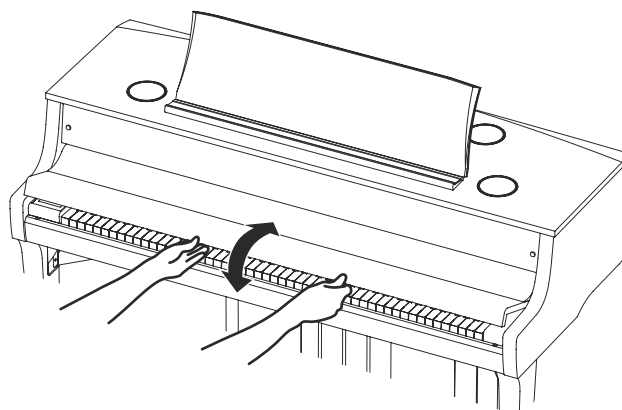

■ Adjusting the music rest

Lift the music rest, then lower the metal prop (rear side) into the recessed holder to set the desired music rest angle.

* The music rest can be set to one of six different angle positions.

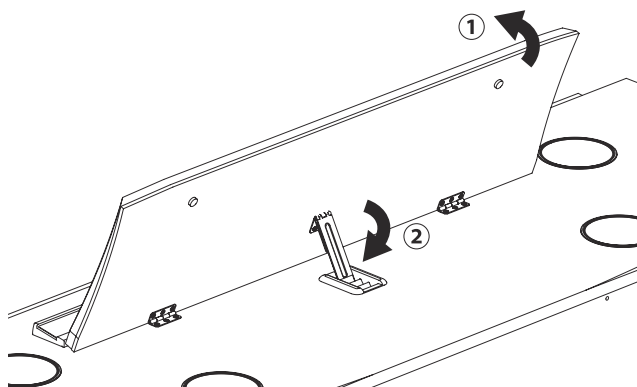
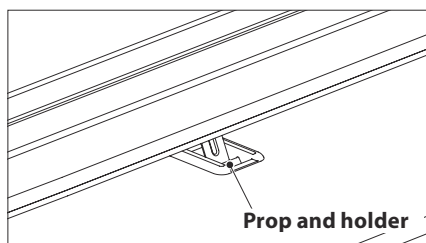

To lower the music rest, gently lift the prop from the recessed holder, then lower the music rest.

* Please lower the music rest slowly in order to avoid injury.

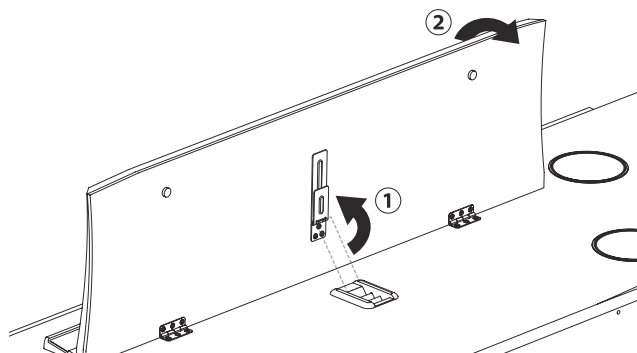

3 Volume and headphones

■ Adjusting the volume

The MASTER VOLUME knob controls the volume level of the instrument's speakers, or headphones if connected.

Turn the knob clockwise to increase the volume, and anti-clockwise to decrease the volume.

Use this knob to set the volume to a comfortable listening level - the middle is often a good starting point.

- * The MASTER VOLUME knob will also affect the volume level of the LINE OUT connectors.
- * The maximum volume level of the speakers can be reduced by using the 'Speaker Volume' setting. Please refer to page 127 for more information.

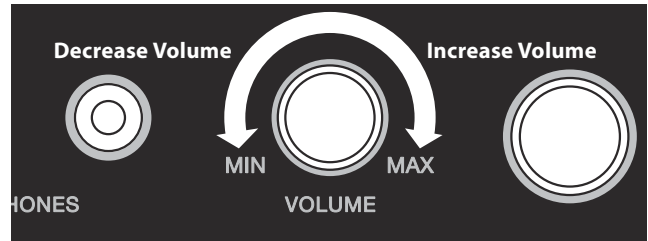

■ Using headphones

Use the jacks located beneath the keyboard on the left hand side to connect stereo headphones to the NV10 hybrid digital piano. 1/4" and 1/8" connectors are provided for convenience.

Two pairs of headphones can be connected and used simultaneously.

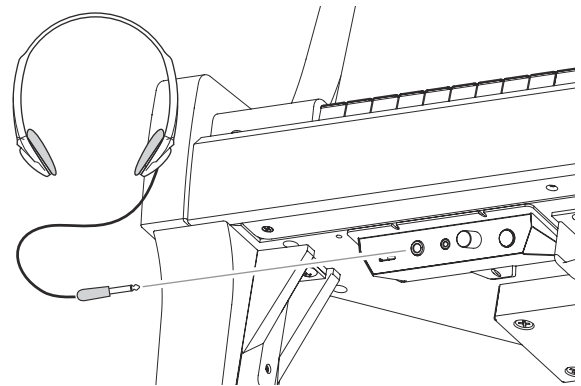

When a pair of headphones is connected, sound will not be produced by the speakers. In addition, the headphones icon will appear in the status bar of the touchscreen display.

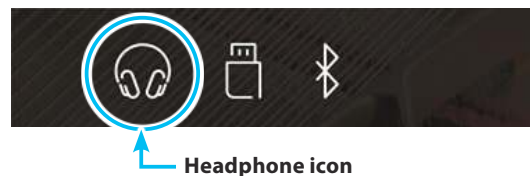

- * The maximum volume level of the headphones output and other headphone characteristics can be adjusted by using the settings in the 'Sound Settings' menu. Please refer to pages 130~132 for more information.

■ Attaching the headphone hook (optional)

A headphone hook is included with the NV10 hybrid digital piano and can be used to hang headphones when not in use.

If desired, attach the headphone hook to the underside of the keyboard as shown in the illustration.

- * For more information, please refer to the 'Assembly Instructions' on page 149.

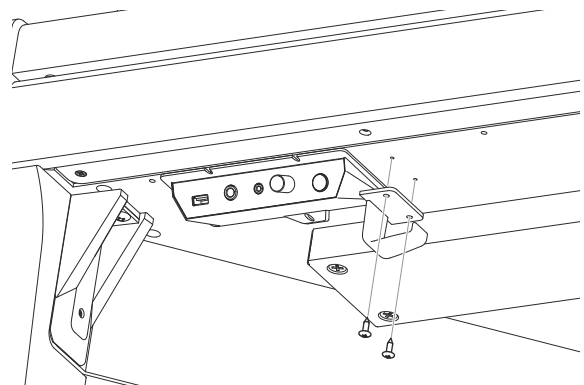

4 Pedals

As with a grand piano, the NV10 hybrid digital piano features three pedals: damper, sostenuto, and soft.

■ Damper pedal (right pedal)

Depressing this pedal sustains the sound after one's hands have been lifted from the keyboard – greatly enriching the piano sound, while also assisting smooth 'legato' passages.

The damper pedal is capable of responding to half pedaling.

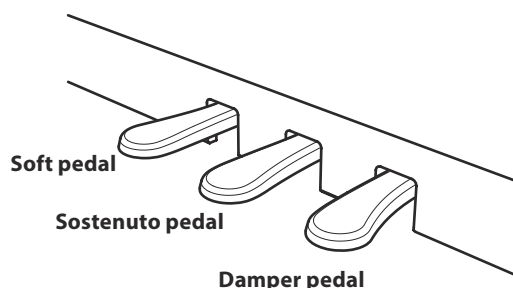

■ Soft pedal (left pedal)

Depressing this pedal softens the sound, reducing its volume.

When the rotary speaker effect is selected, the soft pedal is also used to alternate the speed of the rotary simulation between 'Slow' and 'Fast' effect modes.

■ Sostenuto pedal (centre pedal)

Depressing this pedal after playing the keyboard and before releasing the keys, sustains the sound of only those notes that have been played. Any keys that are subsequently played after the sostenuto pedal is depressed will not be sustained.

■ Pedal support bolt

A pedal support bolt is attached to the base of the pedal board to aid stability when the pedals are pushed.

Turn the bolt anti-clockwise until it makes contact with the floor and supports the pedals firmly. If the pedal support bolt does not make proper contact with the floor, the pedal board may become damaged.

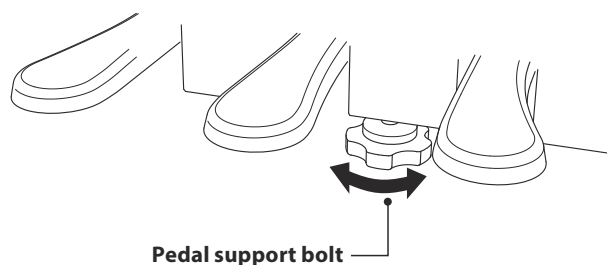

When moving the instrument, always adjust or remove the pedal support bolt, then readjust when the instrument is in its new position.

■ Caring for the pedals

If the surface of the pedals becomes dirty, clean the pedals using a dry dish-washing sponge. Do not attempt to clean the pedals using rust-removing solvents, abrasives or files.

■ Grand Feel Pedal System

The NV10 hybrid digital piano features the Grand Feel Pedal System, which replicates the position and individual weighting of the damper, soft, and sostenuto pedals of a Shigeru Kawai SK Concert Grand piano. It is also possible to adjust the sensitivity of the damper pedal, and the effectiveness of the soft pedal using the 'Half-Pedal Adjust' and 'Soft Pedal Depth' settings.

* For more information, please refer to page 122.

5 Touchscreen Operations

The NV10 hybrid digital piano's touchscreen display is used to provide useful information about the currently selected sound mode/name, function, and setting. The display is also used to control the instrument's various features by tapping on buttons and icons, swiping in different directions, or tapping and holding onscreen elements.

The explanations below outline the different methods of interacting with the touchscreen, and how these operations are referenced in this owner's manual.

■ Tap

This operation is the most common method of selecting sounds and functions, and is performed by momentarily touching areas of the screen (typically buttons and icons) with a single finger.

In this owner's manual, this operation will be referred to as "tap the xxxx button".

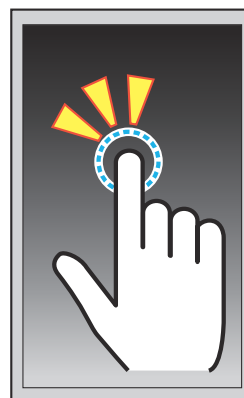

■ Swipe

This operation is frequently used to cycle through lists of sounds, songs, and settings. The operation is performed by touching the screen with a single finger, then sliding up, down, left, or right while lifting the finger from the screen.

In this owner's manual, this operation will be referred to as "swipe left" or "swipe up", etc.

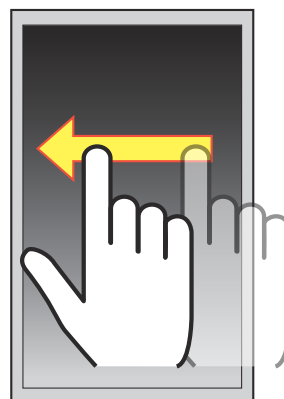

■ Long press

This operation is used when entering numeric values such as the metronome tempo, and is performed by touching and holding a button or icon with a single finger for more than two seconds.

In this owner's manual, this operation will be referred to as "long press the xxxx button".



6 User Interface Overview

The NV10 hybrid digital piano's user interface is arranged into four different screens, which are selected by tapping the corresponding icons shown at the bottom of the touchscreen display.

Screen	Explanation
Pianist mode	The instrument's primary SK-EX Rendering sound engine, recommended for solo piano performance. This screen will appear automatically when the NV10 hybrid digital piano is turned on.
Sound mode	The instrument's secondary sound engine, featuring a broad selection of high quality acoustic piano, electric piano, organ, strings and other sounds that can be layered, split, etc.
Music	The instrument's built-in demonstration songs, piano music pieces, and classical and contemporary lesson songs. This screen is also used to playback internal recorder songs and audio files stored on USB memory devices.
Favorite	Favorite sounds and settings that can be recalled immediately with a single tap.

Typical screen layout

An example of a typical screen (in this case, Pianist mode) and its main components is shown and explained below.

① Status bar

This area indicates the status of connected devices (headphones, USB, Bluetooth), and important functions (transpose, effects, reverb).

② Menu button

This button is used to display the function/settings menu for the current screen.

③ Sound adjustment/selection area

This area is used to change the rendering character and resonance depth of the SK-EX concert grand piano sound (Pianist mode screen), or to select the instrument sound for Single/Dual/Split/4Hands keyboard modes (Sound mode screen).

④ Recorder bar

This area is used to start and stop the instrument's recorder, and change recorder settings.

* For more information about the Recorder function, please refer to page 39.

⑤ Metronome bar

This area is used to start and stop the instrument's built-in metronome/drum rhythms, and change recorder settings.

* For more information about the Metronome function, please refer to page 36.

⑥ Screen bar

This area is used to select the main Pianist mode, Sound mode, Music, and Favorite screens.

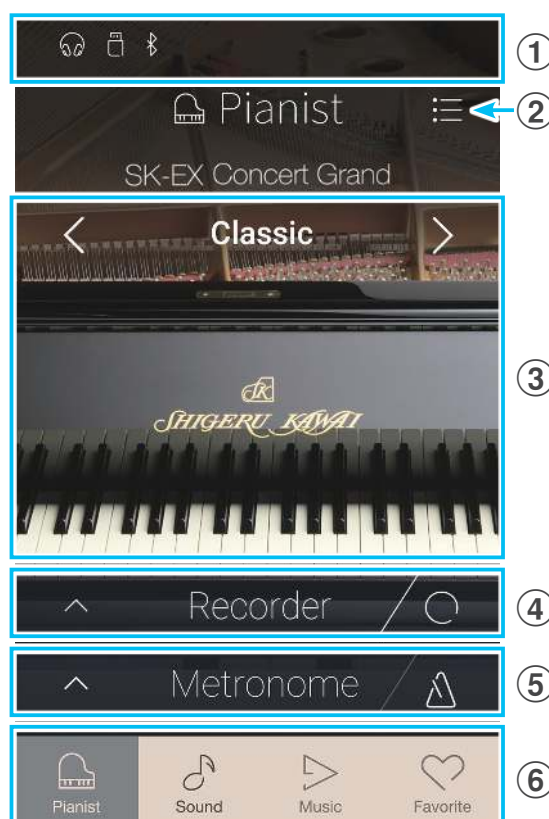

The Status bar, Menu button, Recorder bar, Metronome bar, and Screen bar components are shown on most screens, however their functionality may vary slightly depending on the selected screen.

Setting Up the Piano

■ Status bar

- ① Headphone icon**
Appears when headphones are connected to the instrument, disabling the built-in speakers.
- ② USB Device icon**
Appears when a USB memory device is connected to the instrument.
- ③ Bluetooth icon**
Appears when Bluetooth MIDI or Bluetooth Audio is enabled.
- ④ Transpose icon**
Appears when the Key Transpose setting is changed.
- ⑤ Effects icon**
Appears when the Effects function is turned on (Sounds screen).
- ⑥ Reverb icon**
Appears when the Reverb function is turned on (Sounds screen).



■ Recorder bar

- ① Open Recorder button**
Tap to expand the Recorder bar and show additional recorder settings.
- ② Recorder status**
Indicates the current Recorder status.
- ③ Record Start/Stop button**
Tap to place the Recorder in Standby, then tap again to Start/Stop recording.

* For more information about the Recorder function, please refer to page 39.

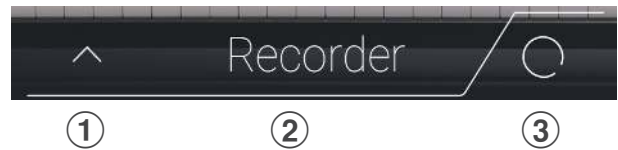

■ Metronome bar

- ① Open Metronome button**
Tap to expand the Metronome bar and show additional metronome/rhythm settings.
- ② Metronome status**
Indicates the current Metronome status.
- ③ Metronome Start/Stop button**
Tap to Start/Stop the Metronome.

* For more information about the Metronome function, please refer to page 36.



■ Screen bar

① Pianist button

Show the Pianist mode screen, utilising the SK-EX Rendering piano sound engine.

② Sound button

Show the Sound mode screen, utilising the multi-instrument sound engine.

③ Music button

Show the Music screen, used for accessing the built-in demonstration songs, piano music pieces, lesson songs, recorder songs, and the USB audio player.

④ Favorite button

Show the Favorite screen, used for recalling favorite sounds and settings.

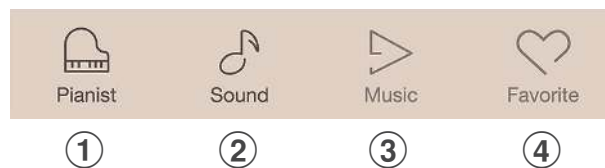

Pianist mode screen

The Pianist mode screen utilises the NV10 hybrid digital piano's new SK-EX Rendering piano sound engine. This mode delivers the most realistic acoustic piano playing experience possible, and is therefore recommended for solo piano performance.

Tap the [Pianist] button to show the Pianist mode screen.

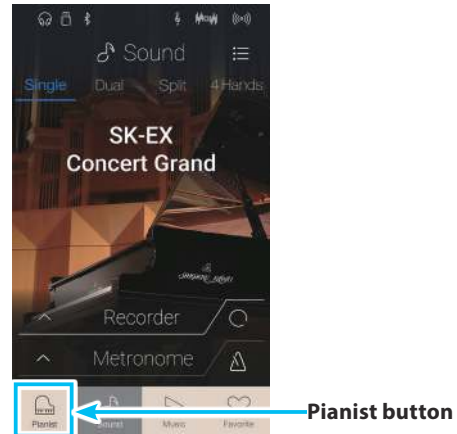

- ① **Menu button**
Tap to display the function/settings menu for the Pianist mode screen.
- ② **Rendering character**
Swipe left/right or tap the arrow buttons to change the rendering character used for the SK-EX Rendering piano sound engine.
- ③ **Resonance depth**
Long press and drag up/down to adjust the resonance depth of the SK-EX Rendering piano sound engine.

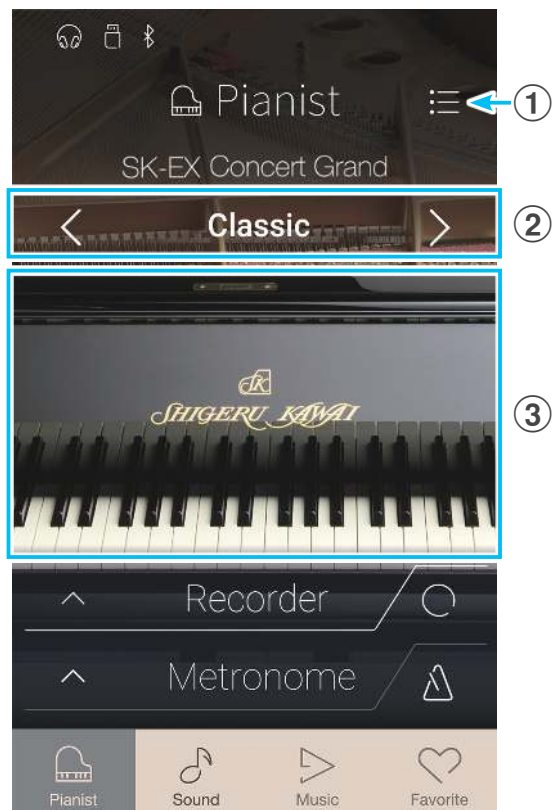

1 Rendering character and Resonance depth

The SK-EX Rendering piano sound engine combines high resolution multi-channel sampling with advanced modelling algorithms to reproduce 10 different acoustic piano rendering characters, suitable for a variety of musical genres.

Rendering character	Description
Classic	A standard grand piano sound with a broad dynamic range.
Romantic	A mellow grand piano sound with soft hammers.
Full	A big grand piano sound with a strong bass and bright character.
Jazz	A clean grand piano sound that is suitable for jazz.
Brilliant	A bright grand piano sound with emphasised treble.
Rich	A rich grand piano sound with emphasised resonances.
Ballad	A clear, light grand piano sound that is suitable for ballads.
Pop	A strong grand piano sound with emphasised attack that is suitable for pop music.
Vintage	A soft grand piano sound with a vintage character.
Boogie	A small grand piano with a detuned character.

■ Selecting the Rendering character

Swipe the Rendering character name left or right, or tap the arrow buttons to cycle through the available rendering characters used for the SK-EX Rendering piano sound engine.

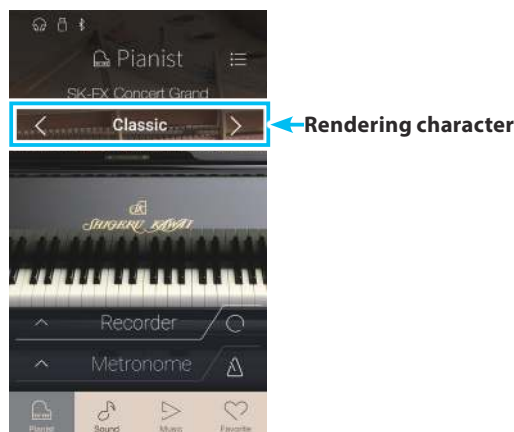

■ Adjusting the Resonance depth

Long press and drag up and down to adjust the Resonance depth of the SK-EX Rendering piano sound engine.

* The Resonance depth can be set to one of 10 levels.



2 Pianist mode menu

The Pianist mode menu contains settings and functions related to the Pianist mode screen.

Tap the [Menu] button to show the Pianist mode menu.

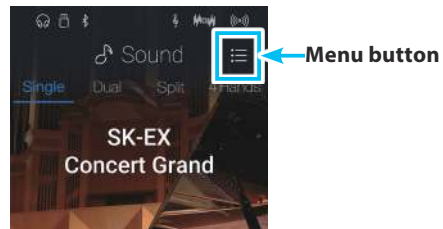

■ Pianist mode menu

① Ambience type

Swipe left/right or tap the arrow buttons to change the ambience type used for the SK-EX Rendering piano sound engine.

Ambience refers to the sense of sound moving around in a virtual room.

* The Ambience type can be set to one of 10 types, listed below.

② Ambience depth

Long press and drag the slider to adjust the depth/strength of the ambience.

③ Pianist Demos

Tap to open the Pianist Demos screen, which performs pieces that demonstrate the SK-EX Rendering piano sound engine.

* Please refer to the table below for more information regarding the pieces of music played on this screen.

④ Virtual Technician

Tap to open the Virtual Technician menu.

This menu is used to adjust various characteristics of the acoustic piano sound.

* For more information about the Virtual Technician menu, please refer to page 98.

⑤ Sound Settings

Tap to open the Sound Settings menu.

This menu is used to adjust various settings of the sound.

* For more information about the Sound Settings menu, please refer to page 123.

⑥ System Settings

Tap to open the System Settings menu.

This menu is used to adjust various system settings.

* For more information about the System Settings menu, please refer to page 133.

⑦ Store to Favorite

Tap to store the current piano sound and associated settings to a Favorite memory.

* For more information about the Favorite function, please refer to page 80.

⑧ Close Menu

Tap to close the menu and return to the Pianist mode screen.

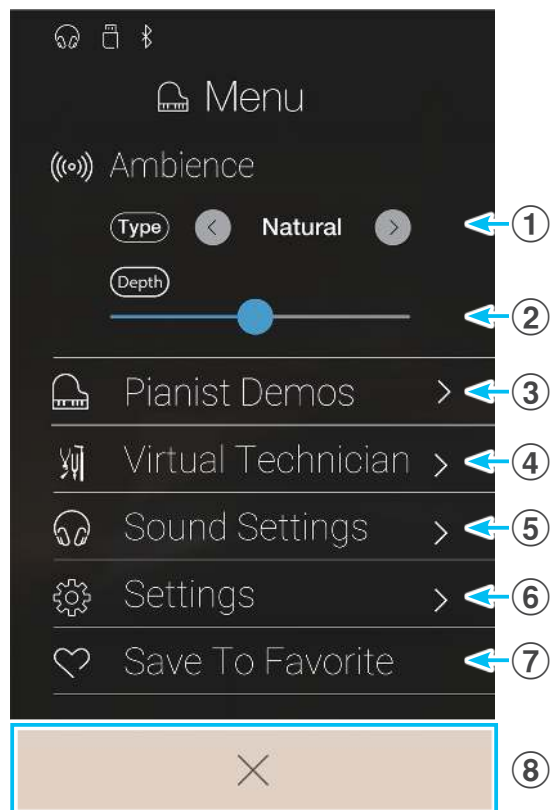

■ Ambience types

Ambience Type	Description
Natural	Simulates the ambience of a natural environment.
Small Room	Simulates the ambience of a small room.
Medium Room	Simulates the ambience of a medium-sized room.
Large Room	Simulates the ambience of a large room.
Studio	Simulates the ambience of a recording studio.
Wood Studio	Simulates the ambience of a wooden recording studio.
Mellow Lounge	Simulates the soft ambience of a lounge.
Bright Lounge	Simulates the bright ambience of a lounge.
Live Stage	Simulates the ambience of a live stage.
Echo	Simulates the ambience of an echo chamber.

■ Pianist Demos pieces

	Piece name	Composer
1	Polonaise in A-flat major, Op. 53	Frédéric Chopin
2	Suite bergamasque - Prélude	Claude Debussy
3	Turkish March	Wolfgang Amadeus Mozart

Sound mode screen

The Sound mode screen utilises the NV10 hybrid digital piano's secondary sound engine. This mode features a wide selection of realistic instrument sounds suitable for various musical styles. These instrument sounds are arranged into eight categories, with several sounds assigned to each category. In addition to playing instrument sounds individually, it is also possible to play two sounds simultaneously, either by layering (Dual) or splitting the keyboard into two sections (Split/4Hands).

* For a complete listing of available instrument sounds, please refer to page 161 of this owner's manual.

Tap the [Sound] button to show the Sound mode screen.

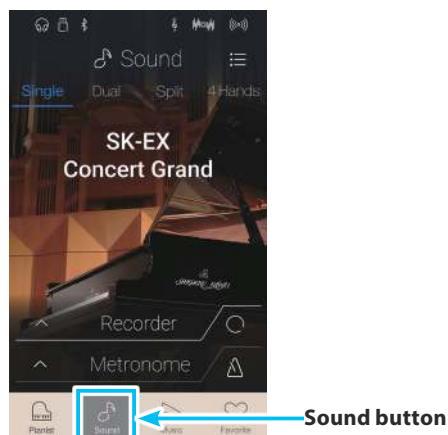

① Menu button

Tap to display the function/settings menu for the Sound mode screen.

② Single

Tap to select the Single keyboard mode. This is the standard mode for playing one sound across the entire length of the keyboard.

③ Dual

Tap to select the Dual keyboard mode. This mode allows two sounds to be layered together.

④ Split

Tap to select the Split keyboard mode. This mode divides the keyboard into two sections, and allows different sounds to be played in each.

⑤ 4Hands

Tap to select the 4Hands keyboard mode. This mode divides the keyboard into two 44-key sections with the same playing range.

⑥ Sound selection area

Tap to open the sound selection pop-up.

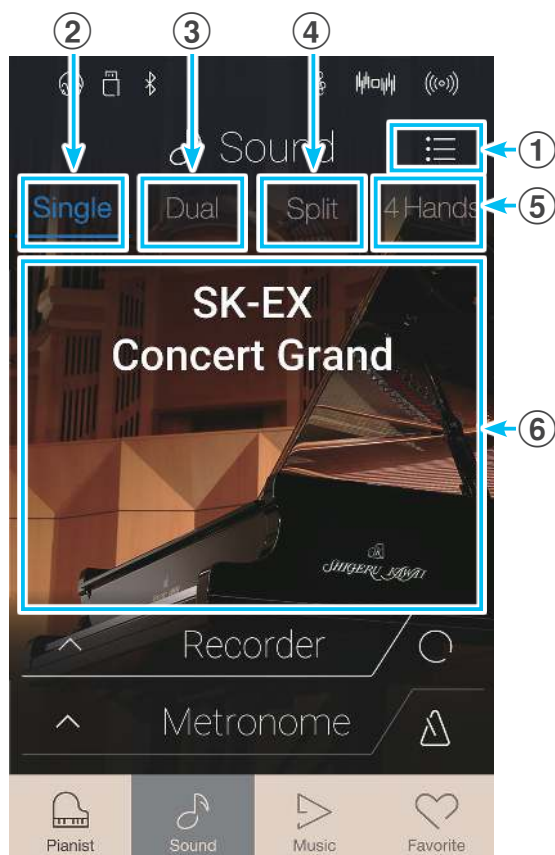

1 Single

By default, the SK-EX Concert Grand piano sound will be selected in Single keyboard mode, meaning that one sound is used across the full width of the keyboard.

■ Selecting sounds

1. Tap the sound selection area to enter sound selection mode.
2. Swipe left or right to cycle through the different instrument sounds in the current category, or up and down to cycle through the different instrument categories.

* The sound selection mode will close automatically after approximately 5 seconds of inactivity.

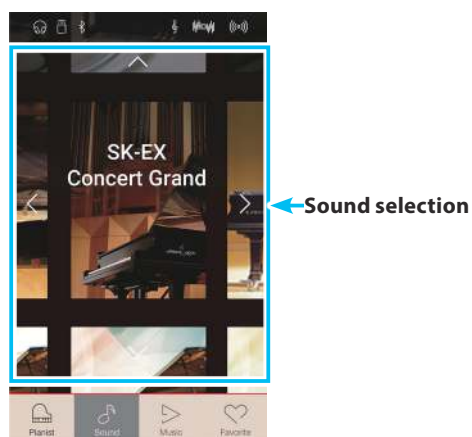

2 Dual

The Dual keyboard mode allows two sounds to be layered together, creating a more complex sound. For example, a piano sound layered with strings, or a church organ combined with a choir, etc.

■ Selecting Dual keyboard mode

Tap the [Dual] button to select Dual keyboard mode.

The sound selection area of the Sound mode screen will divide into two halves. The top half indicates the main sound, while the bottom half indicates the layered sound. By default, Slow Strings will be used for the layered sound.

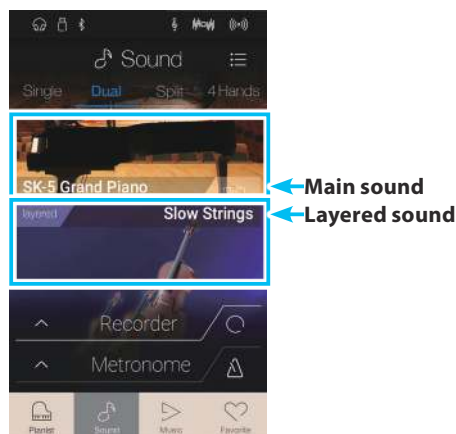

■ Selecting sounds

Selecting sounds in Dual keyboard mode is identical to that of Single keyboard mode.

1. Tap the main or layered sound area to enter sound selection mode.
2. Swipe left/right to change the instrument sound, and up/down to change the instrument category.

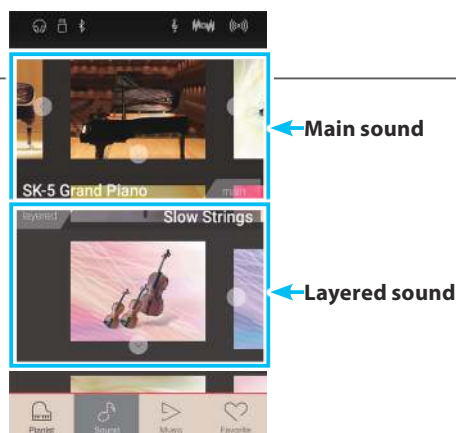

Sound mode screen

■ Dual keyboard mode settings

Dual setting	Description	Default Setting
Balance	Adjust the volume balance between the main and layered sounds.	9 - 9
Layer Octave Shift	Raise/lower the pitch of the layered sound in octave steps.	0
Dynamics	Adjust the dynamic sensitivity of the layered sound relative to the main sound.	10

Tap the [Menu] button to show the Sound mode menu.

Next, tap [Keyboard Settings] to show the Dual keyboard mode settings.

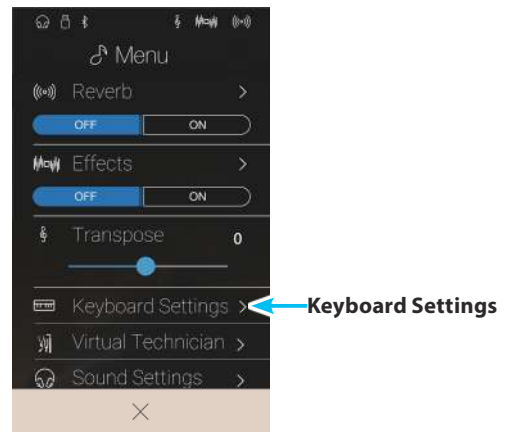

① Back button

Tap to return to the Sound mode menu

② Balance

Long press and drag the slider to adjust the volume balance between the main and layered sounds.

③ Layer Octave Shift

Long press and drag the slider to adjust the pitch of the layered sound in octave steps.

④ Dynamics

Long press and drag the slider to adjust the dynamic sensitivity of the layered sound relative to the main sound.

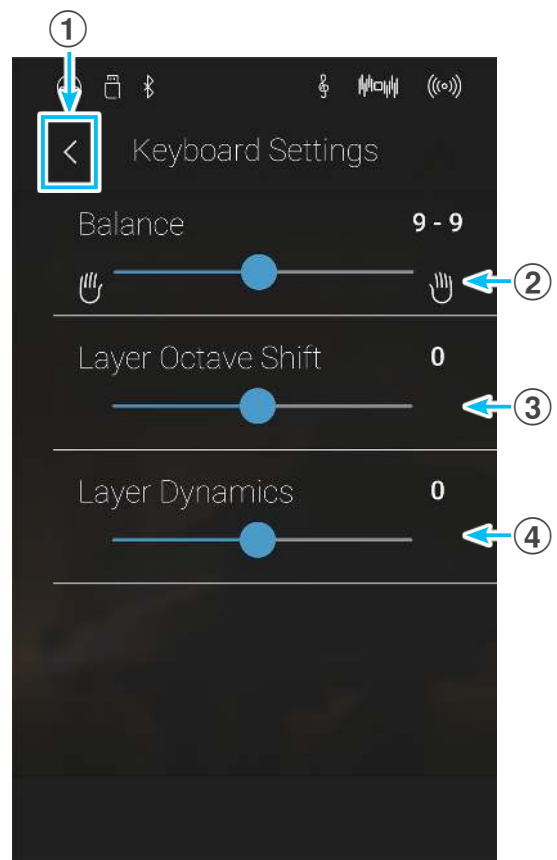

3 Split

The Split keyboard mode function divides the keyboard into two sections, allowing each section to be played with a different sound. For example, a bass sound in the lower section, and a piano sound in the upper section.

■ Selecting Split keyboard mode

Tap the [Split] button to select Split keyboard mode.

The keyboard will divide into upper and lower sections at key C4.

The sound selection area will divide into two halves. The top half indicates the upper section sound, while the bottom half indicates the lower section sound. By default, Wood Bass will be used for the lower section sound.

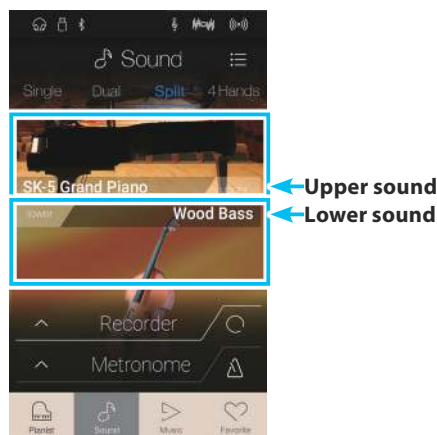

■ Selecting sounds

Selecting sounds in Split keyboard mode is identical to that of Single and Dual keyboard modes.

1. Tap the upper or lower section sound area to enter sound selection mode.
2. Swipe left/right to change the instrument sound, and up/down to change the instrument category.

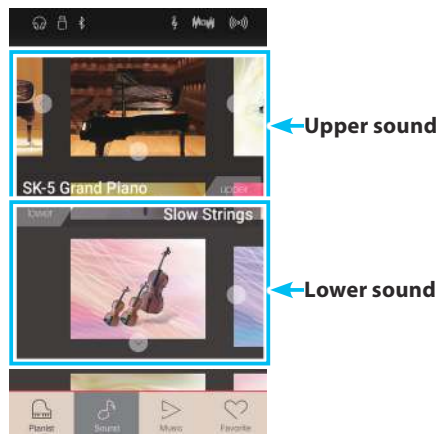

■ Split keyboard mode settings

Split setting	Description	Default Setting
Balance	Adjust the volume balance between the upper section and lower section sounds.	9 - 9
Lower Octave Shift	Raise/lower the pitch of the lower section sound in octave steps.	0
Lower Pedal	Enable/disable the damper pedal for the lower section sound.	Off
Split Point	Set the point on the keyboard that divides the upper and lower sections.	C4

Sound mode screen

Tap the [Menu] button to show the Sound mode menu.

Next, tap [Keyboard Settings] to show the Split keyboard mode settings.

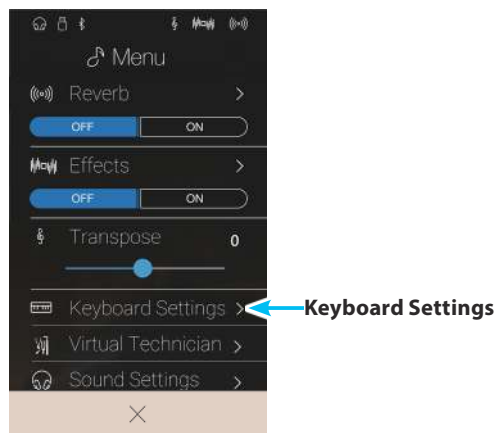

① Back button

Tap to return to the Sound mode menu

② Balance

Long press and drag the slider to adjust the volume balance between the upper section and lower section sounds.

③ Lower Octave Shift

Long press and drag the slider to adjust the pitch of the lower section sound in octave steps.

④ Lower Pedal

Tap to enable/disable the damper pedal for the lower section sound.

⑤ Split Point

Tap to set the point on the keyboard that divides the upper and lower sections.

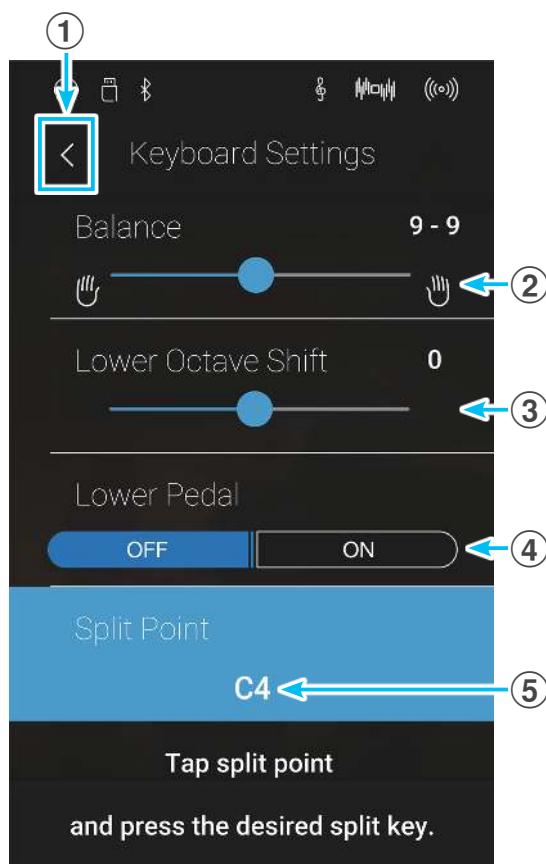

■ Changing the Split point

Tap the [Split Point] setting. A message will appear prompting to press a key.

Press the desired split key on the keyboard.

The pressed key will become the new split point.

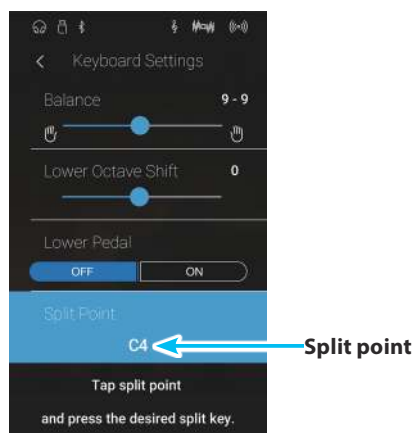

4 Hands

The 4Hands keyboard mode function divides the keyboard into two sections in a similar way to that of the Split keyboard mode. However, with 4Hands keyboard mode enabled, the octave/pitch of each section is automatically adjusted to create two separate 44-key instruments with the same playing range. Furthermore, the damper (right) pedal and soft (left) pedal act as separate damper pedals for the respective upper and lower sections, allowing two people to perform piano duets using a single instrument.

■ Selecting 4Hands keyboard mode

Tap the [4Hands] button to select 4Hands keyboard mode.

The keyboard will divide into right and left sections at key F4.

The sound selection area will divide into two halves. The top half indicates the right section sound, while the bottom half indicates the left section sound. By default, the SK-EX Concert Grand sound will be used for both the right and left sections.

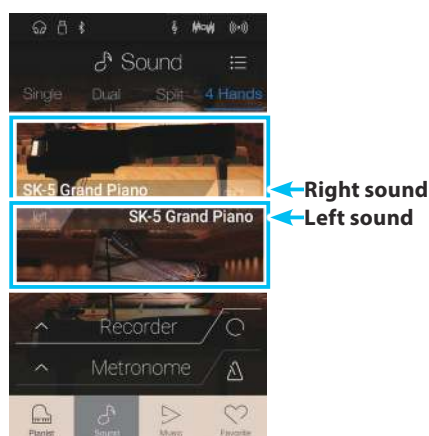

■ Selecting sounds

Selecting sounds in 4Hands keyboard mode is identical to that of Single, Dual, and Split keyboard modes.

1. Tap the right or left section sound area to enter sound selection mode.
2. Swipe left/right to change the instrument sound, and up/down to change the instrument category.

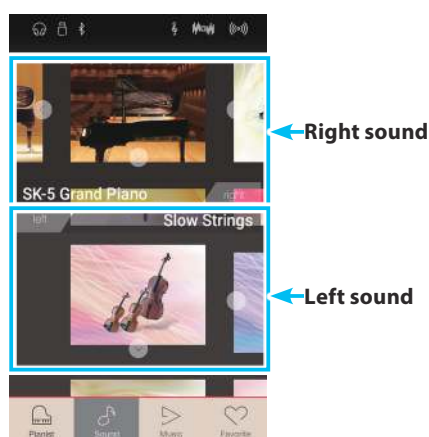

■ 4Hands keyboard mode settings

4Hands setting	Description	Default Setting
Balance	Adjust the volume balance between the right section and left section sounds.	9 - 9
Right Octave Shift	Raise/lower the pitch of the right section sound in octave steps.	0
Left Octave Shift	Raise/lower the pitch of the left section sound in octave steps.	Off
Split Point	Set the point on the keyboard that divides the right and left sections.	F4

Sound mode screen

Tap the [Menu] button to show the Sound mode menu.

Next, tap [Keyboard Settings] to show the 4Hands keyboard mode settings.

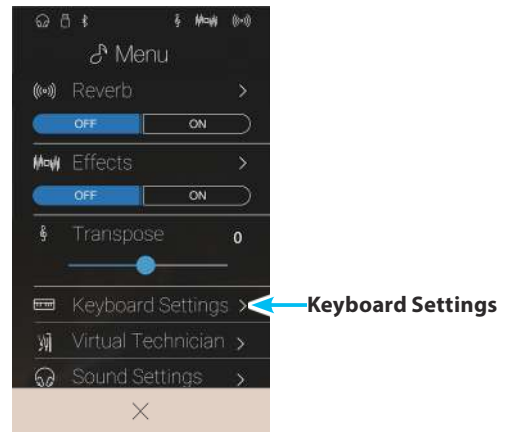

- ① **Back button**
Tap to return to the Sound mode menu
- ② **Balance**
Long press and drag the slider to adjust the volume balance between the right section and left section sounds.
- ③ **Right Octave Shift**
Long press and drag the slider to adjust the pitch of the right section sound in octave steps.
- ④ **Left Octave Shift**
Long press and drag the slider to adjust the pitch of the left section sound in octave steps
- ⑤ **Split Point**
Tap to set the point on the keyboard that divides the right and left sections.

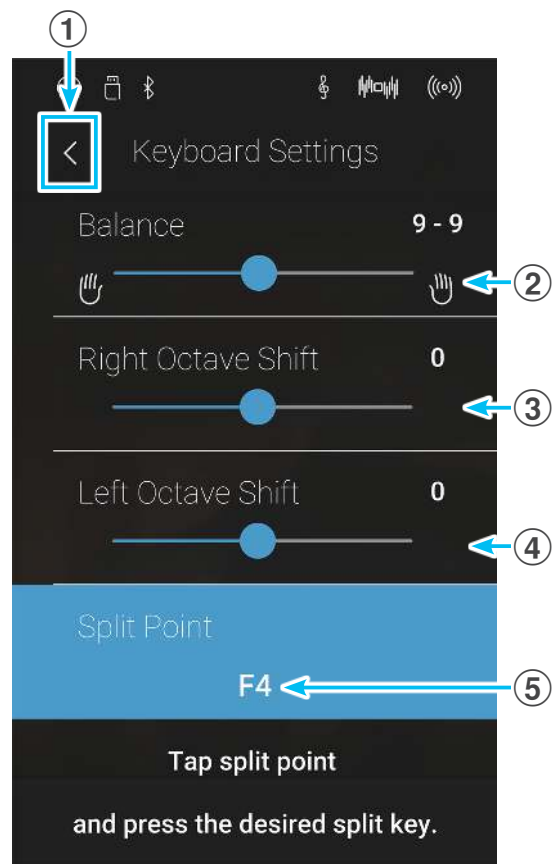

■ Changing the Split point

Tap the [Split Point] setting. A message will appear prompting to press a key.

Press the desired split key on the keyboard.

The pressed key will become the new split point.

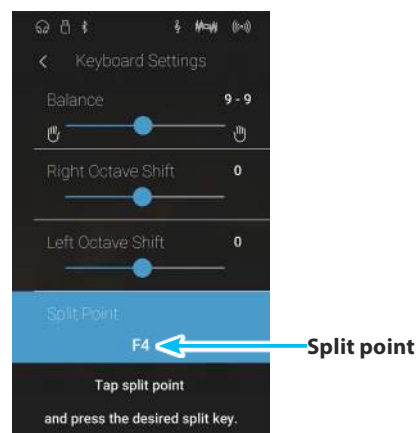

5 Reverb

Reverb adds reverberation to the sound, simulating the acoustic environment of a recital room, stage, or concert hall. Some sound types, such as acoustic pianos, enable reverb automatically in order to improve acoustic realism. The NV10 hybrid digital piano features six different reverb types, which can be adjusted via the Sound mode menu.

■ Turning Reverb on/off

Tap the [Menu] button to show the Sound mode menu.

Next, tap the Reverb [ON/OFF] buttons to turn Reverb on/off.

* When Reverb is turned on, the Reverb icon will be shown in the status bar.



■ Reverb settings

Reverb setting	Description	Range
Type	Change the type of environment.	-
Depth	Adjust the depth of the environment (i.e. amount of reverberation to apply).	1~10
Time	Adjust the decay length/speed of the reverberation.	1~10

* Reverb settings are independent for each sound variation.

Tap the [Menu] button to show the Sound mode menu.

Next, tap [Reverb] to show the Reverb settings.

① Back button

Tap to return to the Sound mode menu

② Type

Swipe left/right or tap the arrow buttons to change the reverb type.

③ Depth

Long press and drag the slider to adjust the depth of the reverb (i.e. amount of reverberation to apply).

④ Time

Long press and drag the slider to adjust the decay length/speed of the reverberation.

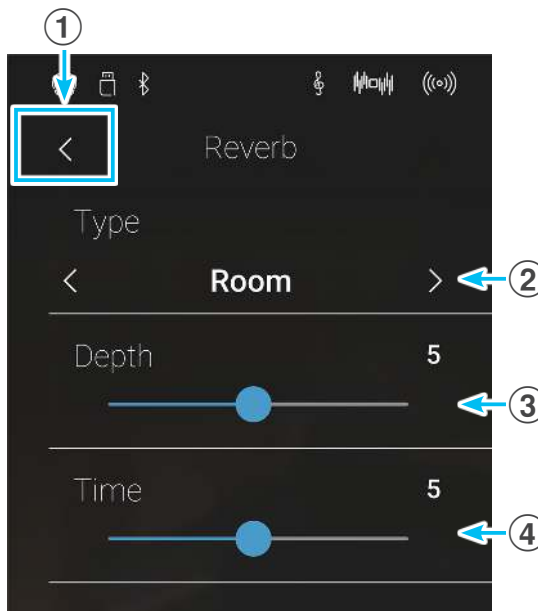

■ Reverb types

Reverb type	Description
Room	Simulates the ambience of a small rehearsal room.
Lounge	Simulates the ambience of piano lounge.
Small Hall	Simulates the ambience of a small hall.
Concert Hall	Simulates the ambience of a concert hall or theatre.
Live Hall	Simulates the ambience of a live hall or stage.
Cathedral	Simulates the ambience of a large cathedral.

6 Effects

In addition to reverb, various other effects can be applied to the selected sound, altering the tonal character and feeling of the instrument. As with reverb, some sound types enable certain effects automatically in order to enhance tonal quality. The NV10 hybrid digital piano features 19 different effect types, with 2 combination effects, and 3 additional amplified effects. Effects are also adjusted via the Sound mode menu.

■ Turning Effects on/off

Tap the [Menu] button to show the Sound mode menu.

Next, tap the Effects [ON/OFF] buttons to turn Effects on/off.

* When Effects is turned on, the Effects icon will be shown in the status bar.



← Effects On/Off buttons

■ Effects settings

Effects setting	Description	Range
Type	Change the type of effect.	-
Setting 1	Adjust the primary setting of the effect (e.g. Dry/Wet level).	1~10
Setting 2	Adjust the secondary setting of the effect (e.g. Time).	1~10

* Effects settings are independent for each sound variation.

Tap the [Menu] button to show the Sound mode menu.

Next, tap [Effects] to show the Effect settings.

① Back button

Tap to return to the Sound mode menu

② Type

Swipe left/right or tap the arrow buttons to change the effect type.

③ Setting 1

Long press and drag the slider to adjust the primary effect setting (e.g. Dry/Wet level).

④ Setting 2

Long press and drag the slider to adjust the secondary effect setting (e.g. Time).

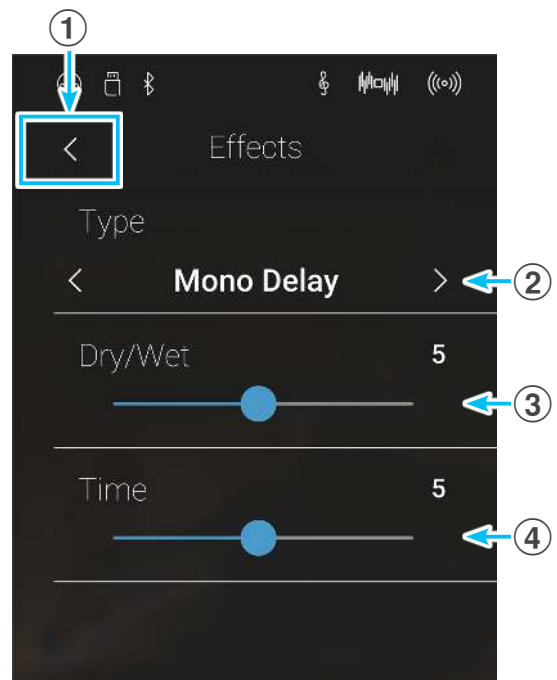

■ Effect types

Effect type	Description
Mono Delay	Applies an echo effect to the sound, playing through both speakers simultaneously.
Ping Delay	Applies a 'ping pong' echo effect to the sound, giving the impression that it is 'bouncing' from left to right.
Triple Delay	Similar in principle to Ping Delay, but with an additional centre echo.
Chorus	Layers a slightly detuned version of the sound over the original, thus enriching its tonal character.
Classic Chorus	Similar in principle to Chorus, but intended for vintage electric piano sounds.
Ensemble	Applies a three-phase chorus to the sound, providing additional richness.
Tremolo	Continuously varies the volume at a constant speed, adding a vibrato type effect to the sound.
Classic Tremolo	Similar in principle to Tremolo, but intended for vintage electric piano sounds.
Vibrato Tremolo	Similar in principle to Tremolo, but with an additional Vibrato effect applied.
Auto Pan	Alternates the sound output from left to right across the stereo field using a sine wave.
Classic Auto Pan	Similar in principle to Auto Pan, but intended for vintage electric piano sounds.
Phaser	Applies a cyclic phase change to the sound, giving the impression that the sound is moving.
Classic Phaser	Similar in principle to Phaser, but intended for vintage electric piano sounds.
Rotary (1~6)	<p>Simulates the sound of a rotary speaker commonly used with vintage electronic organs. There are three different levels of overdrive, with and without a Chorus effect.</p> <p>* The soft pedal can be used to alternate the speed of the rotary simulation between 'Slow' and 'Fast' effect modes.</p>
Combination Effects	<p>Different combinations of the above effects, applied simultaneously.</p> <p>* Combination effect types: Phaser+Chorus, Phaser+AutoPan</p>
Amplified Effects	<p>A selection of the above effects, with a vintage electric piano speaker effect applied.</p> <p>* Amplified effect types: Tremolo+Amp, Auto Pan+Amp, Phaser+Amp</p>

■ Effect parameters

Effect parameter	Effect setting	Description
Mono Delay / Ping Delay / Triple Delay	Dry / Wet	Adjust the intensity of the delay.
	Time	Adjust the interval of time between each delay.
Chorus / Ensemble	Dry / Wet	Adjust the intensity of the chorus.
	Speed	Adjust the speed of the chorus.
Classic Chorus	Mono / Stereo	Toggle between a Mono or Stereo effect.
	Speed	Adjust the speed of the chorus.
Tremolo / Classic Tremolo / Vibrato Tremolo	Dry / Wet	Adjust the intensity of the tremolo.
	Speed	Adjust the speed of the tremolo.
Auto Pan / Classic Auto Pan	Dry / Wet	Adjust the intensity of the pan.
	Speed	Adjust the speed of the pan.
Phaser / Classic Phaser	Dry / Wet	Adjust the intensity of the phaser.
	Speed	Adjust the speed of the phaser.
Rotary	Accel. Speed	Adjust the acceleration speed between slow and fast modes.
	Rotary Speed	Adjust the speed of the rotary speaker.
Combination Effects / Amplified Effects	Dry / Wet	Adjust the intensity of the effects.
	Speed	Adjust the speed of the effects.

Metronome / Drum Patterns

The Metronome function provides a steady beat to aid practicing the piano at a consistent tempo. In addition to regular metronome beats, the NV10 hybrid digital piano also features a variety of drum rhythms to accompany most playing styles and musical genres. The Metronome function is available on both the Pianist mode screen and the Sound mode screen.

■ Turning the Metronome on/off

Tap the [Metronome Start/Stop] button.

The Metronome Start/Stop button will change colour, and a 4/4 beat will start to count.

The current metronome beat and tempo will also be shown in the Metronome status bar.

Tap the [Metronome Start/Stop] button again to stop the metronome.

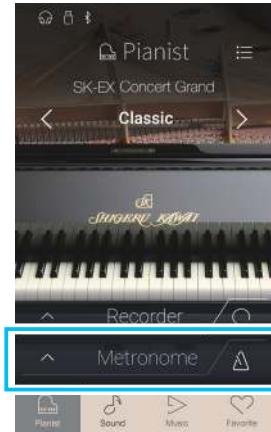

Metronome settings

The Metronome settings allow the tempo, beat, and volume of the metronome to be adjusted.

Tap the [Open Metronome] button to expand the Metronome bar and show the additional metronome/rhythm settings.

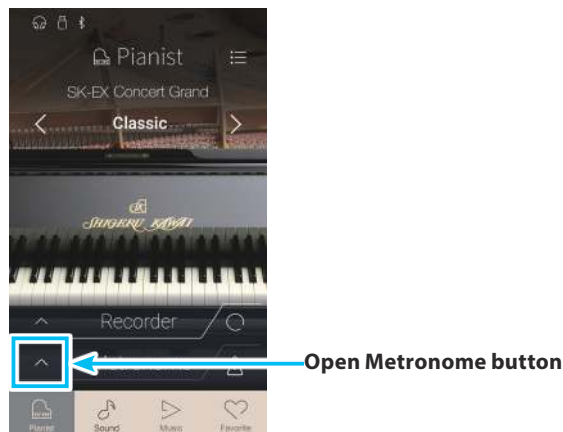

Metronome settings

- ① **Metronome bar**
Tap to close the metronome settings.
- ② **Metronome mode button**
Tap the [METRONOME] button to select metronome mode, or the [DRUM] button to select drum rhythm mode.
- ③ **Tempo term selection**
Swipe left/right or tap the arrow buttons to change the preset tempo term.
* There are 17 tempo presets, ranging from Grave to Prestissimo.
- ④ **Tempo selection**
Swipe each digit up/down or tap the arrow buttons to adjust the metronome tempo.
* The metronome tempo can be adjusted with the range of 10~400 BPM.
- ⑤ **Time signature selection**
Swipe left/right or tap the arrow buttons to change the metronome time signature.
When the metronome is counting, the current beat (of the bar) will also be shown.
* There are ten different time signatures available: 1/4, 2/4, 3/4, 4/4, 5/4, 3/8, 6/8, 7/8, 9/8, and 12/8.
- ⑥ **Metronome volume**
Long press and drag the slider to adjust the volume of the metronome.
- ⑦ **Metronome Start/Stop button**
Tap to start/stop metronome.



Drum rhythms

As an alternative to the simple metronome count, it is also possible to select a drum pattern from one of 100 different rhythm styles.

For a complete listing of available drum rhythms, please refer to page 170 of this owner's manual.

While the metronome settings menu is open, tap the [DRUM] button to select drum rhythm mode.

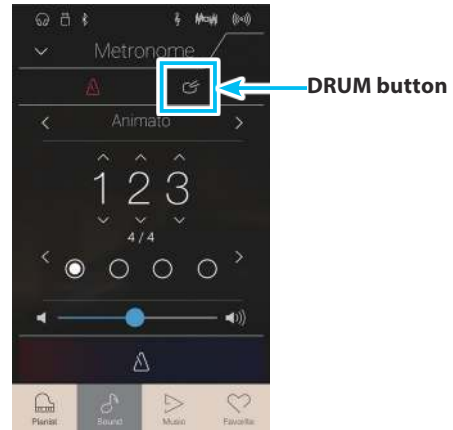

■ Drum rhythm settings

① Metronome bar

Tap to close the metronome settings.

② Metronome mode button

Tap the [METRONOME] button to select metronome mode, or the [DRUM] button to select drum rhythm mode.

③ Drum rhythm category

Swipe left/right or tap the arrow buttons to change the drum rhythm category.

* There are 11 drum rhythm categories, ranging from 8 Beat to Latin.

④ Tempo selection

Swipe each digit up/down or tap the arrow buttons to adjust the drum rhythm tempo.

* The drum rhythm tempo can be adjusted with the range of 10~400 BPM.

⑤ Drum rhythm pattern selection

Swipe left/right or tap the arrow buttons to change the drum rhythm pattern.

When the drum rhythm is counting, the current beat (of the bar) will also be shown.

* There are multiple drum rhythm patterns in each category.

⑥ Drum rhythm volume

Long press and drag the slider to adjust the volume of the drum rhythm.

⑦ Drum rhythm Start/Stop button

Tap to start/stop the drum rhythm.

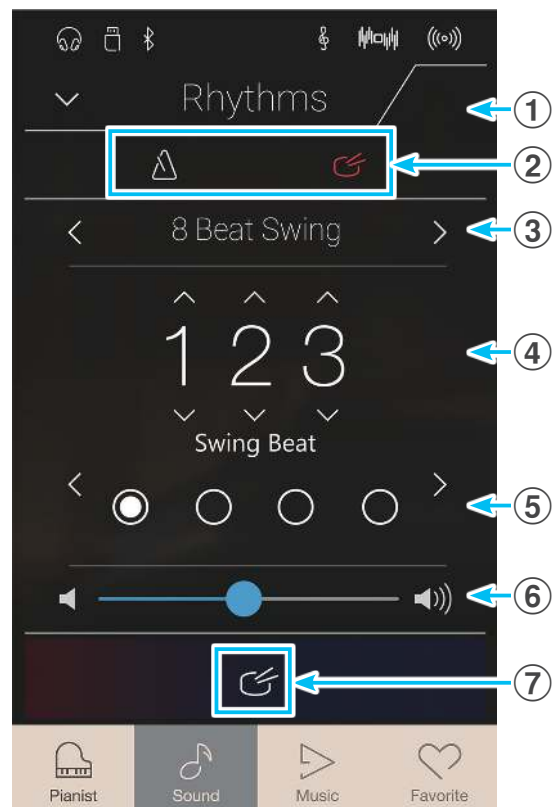

About the Recorder

The Recorder function allows performances to be recorded and stored in the NV10 hybrid digital piano's internal memory, or saved to a connected USB memory device. The recording format and capabilities differ between Pianist mode and Sound mode.

Recorder file format and capabilities

	Internal Recorder		USB Audio Recorder
	Pianist Mode	Sound Mode	Pianist Mode & Sound Mode
Recorder Format	MP3 audio (256 kbit/s)	Kawai song format	MP3 audio (256 kbit/s), WAV audio (1411 kbit/s)
No. of parts	1 part	2 parts	1 part
No. of song memories	3 songs	10 songs	n/a (dependent on memory device)
Maximum capacity	10 minutes (per song)	90,000 notes total (all songs)	n/a (dependent on memory device)
Changes recorded & played back	All changes	All changes except: Tempo Dual/Split balance Reverb/Effect settings* Virtual Technician settings*	All changes

MPEG Layer-3 audio coding technology licensed from Fraunhofer IIS and Thomson.

* In Sound mode, the current Reverb, Effects, and Virtual Technician settings will be used when the internal recorder song is played back.

Record Start/Stop button

The Record Start/Stop button (Pianist mode and Sound mode) provides a quick way to start and stop recording without opening the main Recorder bar settings.

1. Tap the [Record Start/Stop] button.

The Recorder will enter Standby mode.

* Press and hold the [Record Start/Stop] button to cancel the Standby mode.

2. Press a key on the keyboard, or tap the [Record Start/Stop] button again.

The [Record Start/Stop] button will change colour, and the recording will start.

* Press the [Metronome Start/Stop] button before or during the recording to turn on the metronome. The metronome 'click' sound will not be recorded.

3. Tap the [Record Start/Stop] button again to stop the recording.



Song Recorder (Internal memory)

1 Recording a song: Pianist mode

In Pianist mode, the NV10 hybrid digital piano allows up to 3 different songs to be recorded, stored in internal memory, and immediately played back.

Recorder bar

Tap the Recorder bar to expand the Recorder.

1 Recorder bar

Tap to close the Recorder settings.

2 Recorder menu

Tap to open the Recorder menu.

3 Recorder mode

Tap to select whether the Recorder should record to internal memory or USB memory.

* If a USB memory device is connected to the NV10 hybrid digital piano, USB Audio mode will be selected automatically.
If a USB memory device is not connected, this setting will not be shown, and the Internal recorder mode will be used.

4 Song memory selection

Swipe left/right or tap the arrow buttons to change the song memory to be used for recording.

* In Pianist mode, up to 3 songs can be recorded.

5 Play/Stop button

Tap to Play/Stop the currently selected song.

6 Record Start/Stop button

Tap to place the Recorder in Standby, then tap again to Start/Stop recording.

7 Metronome bar

Tap to open the Metronome settings and/or Start/Stop the metronome.

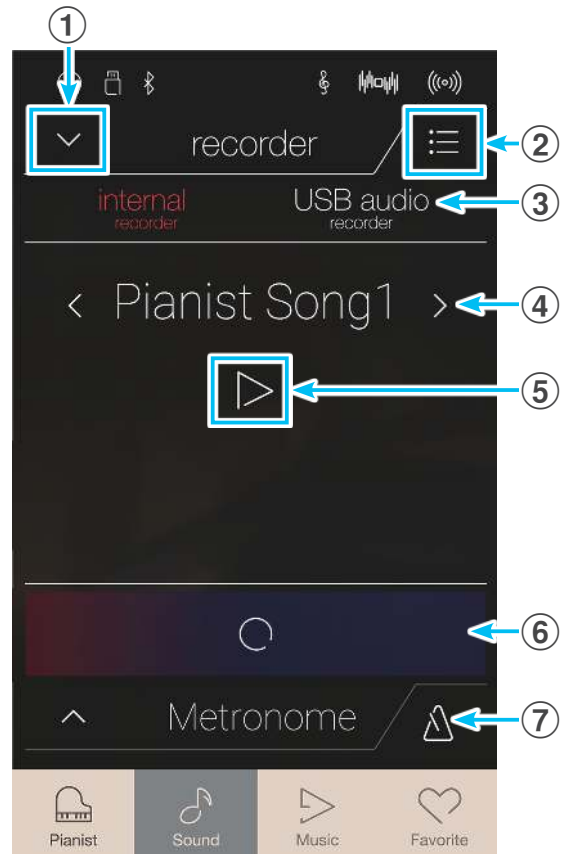

Selecting the song memory

Swipe the song memory left/right or tap the arrow buttons to change the song memory to be used for recording.

* In Pianist mode, up to 3 songs can be recorded.

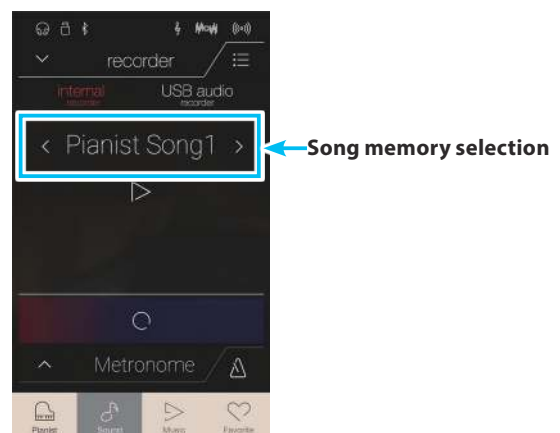

■ Recording a song

1. Tap the [Record Start/Stop] button.

The Recorder will enter Standby mode.

- * Press and hold the [Record Start/Stop] button to cancel the Standby mode.

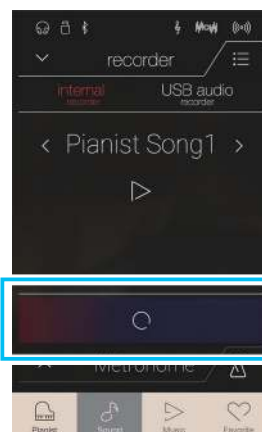

2. Press a key on the keyboard, or tap the [Record Start/Stop] button again.

The [Record Start/Stop] button will change colour, and the recording will start.

- * Press the [Metronome Start/Stop] button before or during the recording to turn on the metronome. The metronome 'click' sound will not be recorded.

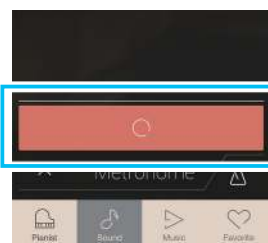

3. Tap the [Record Start/Stop] button again to stop the recording.

- * In Pianist mode, the maximum internal recording capacity is approximately 10 minutes per song memory.

- * If the maximum recording capacity is reached during recording, the recorder will stop automatically.

- * Recorder songs will remain in memory after the power is turned off.

- * During recording, it will not be possible to select Sound mode.

- * Recording to a song memory that has already been recorded to, will result in that song being overwritten.

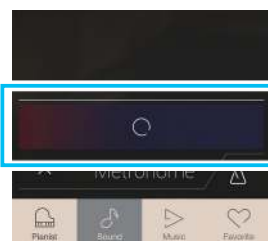

■ Playing the song

1. Tap the [Play/Stop] button.

The previously recorded song will start to play.

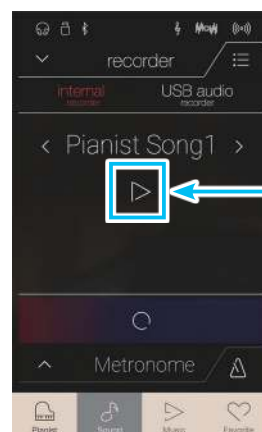

Song Recorder (Internal memory)

2. Tap the [Play/Stop] button again to stop playback.

* For more information about playing back Recorder songs, please refer to page 69.

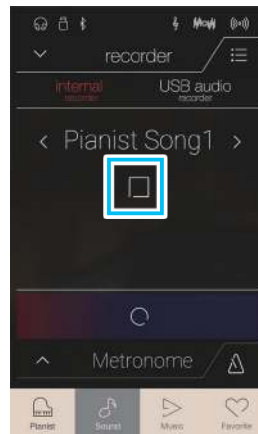

Erasing the song

1. Tap the [Menu] button.

The Pianist mode internal recorder menu will be shown.

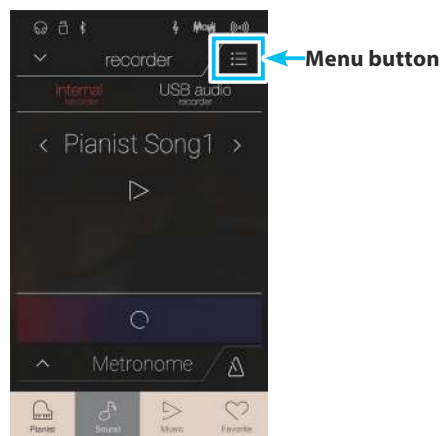

2. Tap [Erase Song].

A confirmation box will be shown.

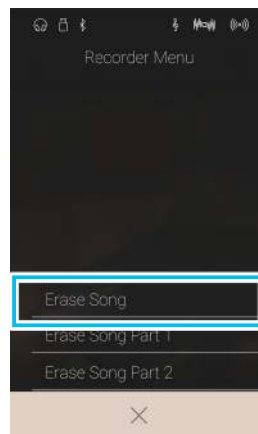

3. Tap the [Yes] button to erase the song, or the [No] button to cancel.

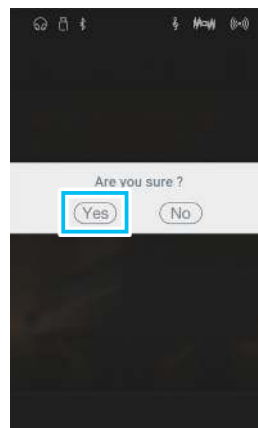

2 Recording a song: Sound mode

In Sound mode, the NV10 hybrid digital piano allows up to 10 different songs to be recorded, stored in internal memory, and immediately played back. In addition, each song can consist of two separate tracks – referred to as ‘parts’ – that can be recorded and played back independently. This allows the left-hand part of a song to be recorded first on one track, and the right-hand part to be recorded later on the other track.

Recorder bar

Tap the Recorder bar to expand the Recorder.

1 Recorder bar

Tap to close the Recorder settings.

2 Recorder menu

Tap to open the Recorder menu.

3 Recorder mode

Tap to select whether the Recorder should record to internal memory or USB memory.

* If a USB memory device is connected to the NV10 hybrid digital piano, USB Audio mode will be selected automatically.

If a USB memory device is not connected, this setting will not be shown, and the Internal recorder mode will be used.

4 Song memory selection

Swipe left/right or tap the arrow buttons to change the song memory to be used for recording.

* In Sound mode, up to 10 songs can be recorded.

5 Play/Stop button

Tap to Play/Stop the currently selected song.

6 Part record selection button

Tap to select which part (part 1 or part 2) of the song to record. When a part is selected for recording, the circle will turn red.

7 Part playback selection button

Tap to select which part (part 1 or part 2) of the song to playback.

 Part has not been recorded to.

 Part has been recorded, and is enabled for playback.

 Part has been recorded, but is not enabled for playback.

8 Record Start/Stop button

Tap to place the Recorder in Standby, then tap again to Start/Stop recording.

9 Metronome bar / Metronome Start/Stop button

Tap to open the Metronome settings and/or Start/Stop the metronome.

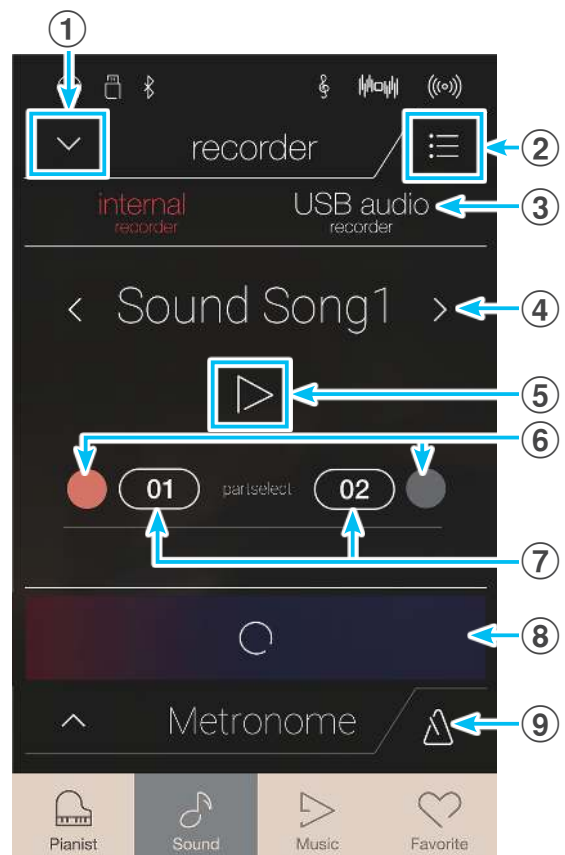

Song Recorder (Internal memory)

■ Selecting the song memory and part

1. Swipe the song memory left/right or tap the arrow buttons to change the song memory to be used for recording.

* In Sound mode, up to 10 songs can be recorded.

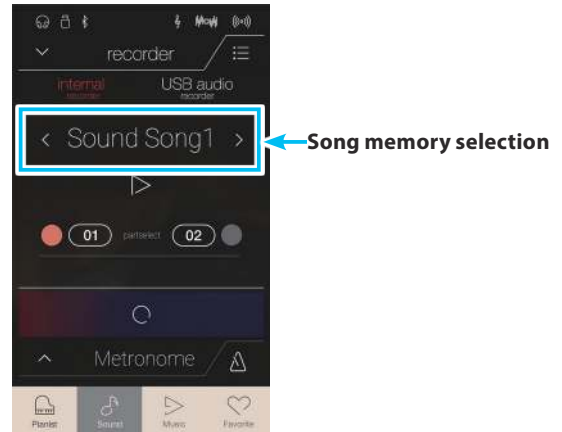

2. Tap the circle button to the left of the [01] button to select part1 for recording.

* The circle will turn red to indicate that this part will be recorded to.

* If a part has already been recorded to, the part button will be filled blue or white.

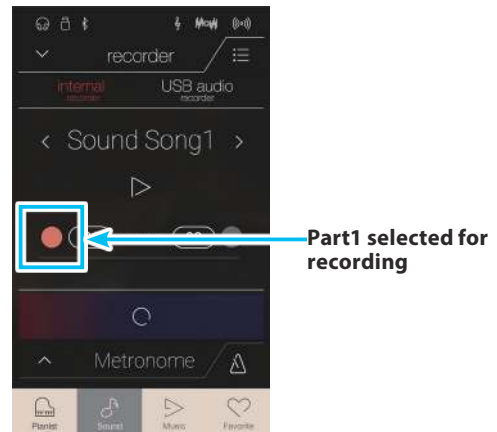

■ Recording the song (part1)

1. Tap the [Record Start/Stop] button.

The Recorder will enter Standby mode.

* Press and hold the [Record Start/Stop] button to cancel the Standby mode.

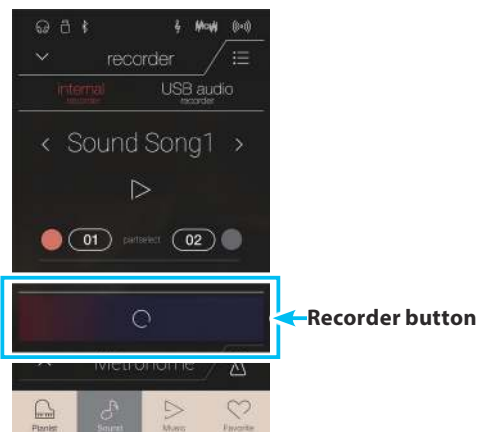

2. Press a key on the keyboard, or tap the [Record Start/Stop] button again.

The [Record Start/Stop] button will change colour, and the recording will start.

* Press the [Metronome Start/Stop] button before or during the recording to turn on the metronome. The metronome 'click' sound will not be recorded.



3. Tap the [Record Start/Stop] button again to stop the recording.

The selected [01] button will change colour (blue) to indicate that part1 has been recorded to.

- * In Sound mode, the maximum internal recording capacity is approximately 90,000 notes, with button and pedal presses also counted as one note.
- * If the maximum recording capacity is reached during recording, the recorder will stop automatically.
- * Recorder songs will remain in memory after the power is turned off.
- * During recording, it will not be possible to select Pianist mode.
- * Recording to a part that has already been recorded to, will result in that part being overwritten.

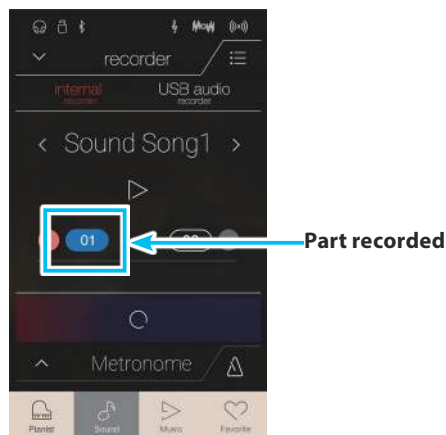

■ Playing the song (part1)

1. Tap the [Play/Stop] button.

The previously recorded part1 of the song will start to play.

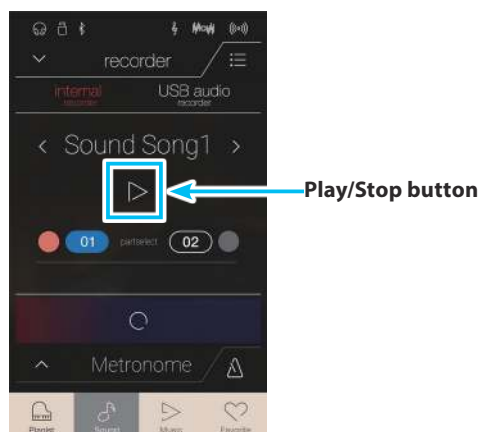

2. Tap the [Play/Stop] button again to stop playback.

* For more information about playing back Recorder songs, please refer to page 69.

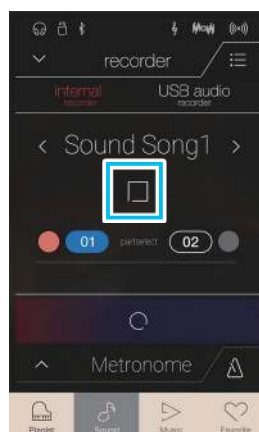

■ Recording the song (part2)

1. Tap the circle button to the right of the [02] button to select part2 for recording.

* The circle will turn red to indicate that this part will be recorded to.

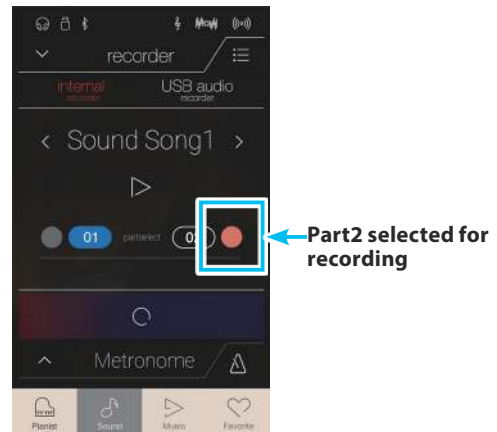

2. Tap the [Record Start/Stop] button.

The Recorder will enter Standby mode.

* Press and hold the [Record Start/Stop] button to cancel the Standby mode.

3. Press a key on the keyboard, or tap the [Record Start/Stop] button again.

The [Record Start/Stop] button will change colour, and the recording will start.

The previously recorded part1 will also be played.

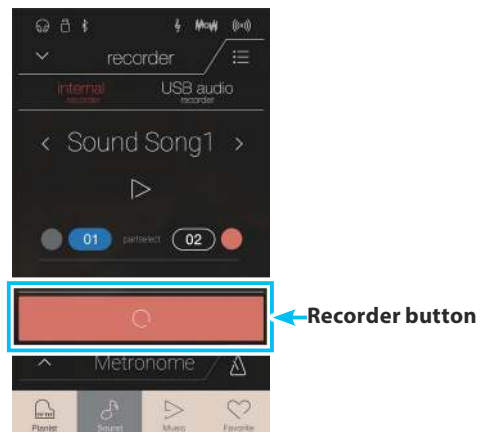

4. Tap the [Record Start/Stop] button again to stop the recording.

The selected [02] button will change colour (blue) to indicate that part2 has been recorded to.

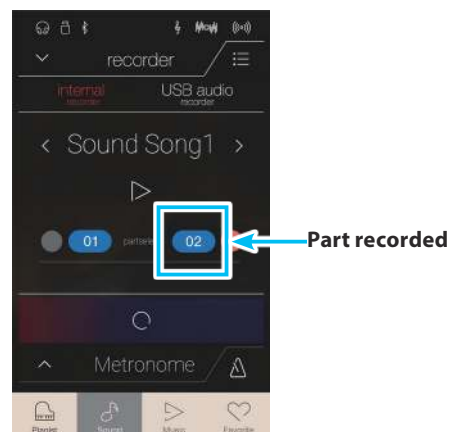

■ Playing the song (part2)

1. Tap the [Play/Stop] button.

The previously recorded part1 and part2 of the song will start to play simultaneously.

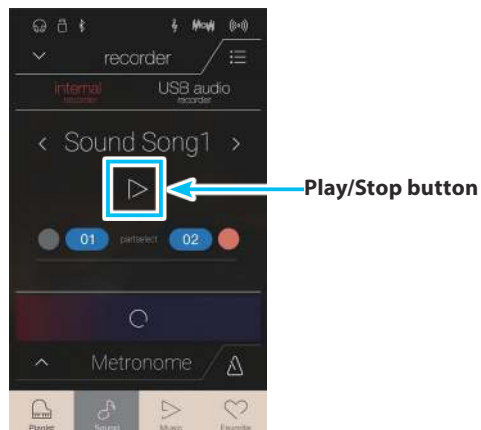

2. Tap the [Play/Stop] button again to stop playback.

* For more information about playing back Recorder songs, please refer to page 69.

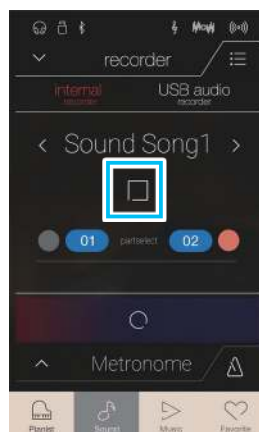

3. Tap the [01] button.

The [01] button will change colour (white) to indicate that part1 has been recorded to, but is not enabled for playback.

4. Tap the [Play/Stop] button.

The previously recorded part2 of the song will start to play, with part1 muted.

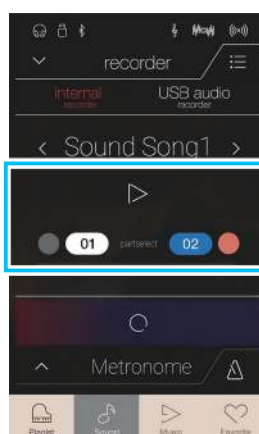

Song Recorder (Internal memory)

Erasing the song/part

1. Tap the [Menu] button.

The Sound mode internal recorder menu will be shown.

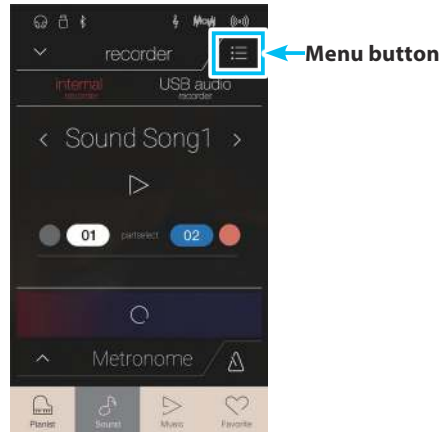

2. Tap [Erase Song] or [Erase Song Part1/Part2].

A confirmation box will be shown.

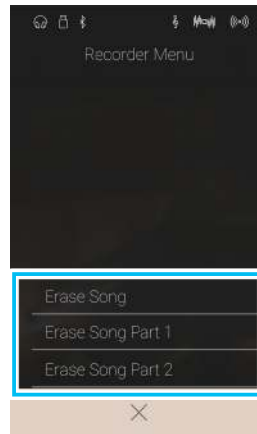

3. Tap the [Yes] button to erase the song/part, or the [No] button to cancel

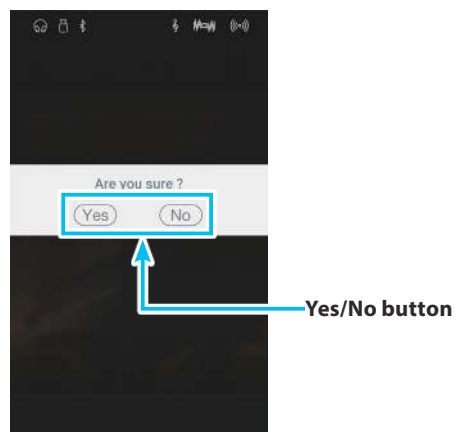

Audio Recorder (USB memory)

1 Recording an audio file: Pianist and Sound mode

The NV10 hybrid digital piano is also capable of recording performances as digital audio – saving the data to a USB memory device in either MP3 or WAV format. This useful function allows professional quality recordings to be produced directly on the instrument – without the need for additional sound equipment – then emailed to friends and family, listened to away from the instrument, or edited and remixed further using an audio workstation.

In addition, the LINE IN audio and Bluetooth Audio (if connected) will also be mixed and recorded to the MP3/WAV audio file.

* If a USB memory device is connected to the NV10 hybrid digital piano, USB Audio mode will be selected automatically.

Recorder bar

Tap the Recorder bar to expand the Recorder.

1 Recorder bar

Tap to close the Recorder settings.

2 Recorder menu

Tap to open the Recorder menu.

3 Recorder mode

Tap to select whether the Recorder should record to internal memory or USB memory.

* If a USB memory device is connected to the NV10 hybrid digital piano, USB Audio mode will be selected automatically.
If a USB memory device is not connected, this setting will not be shown, and the Internal recorder mode will be used.

4 Audio filename

Indicates the filename of the recorded audio file.

* 'New Song 01' will be used as the default name for the recorded audio file, with the number increasing automatically.

5 Play/Stop button

Tap to Play/Stop the current audio file.

6 Record Start/Stop button

Tap to place the Recorder in Standby, then tap again to Start/Stop recording.

7 Metronome bar / Metronome Start/Stop button

Tap to open the Metronome settings and/or Start/Stop the metronome.

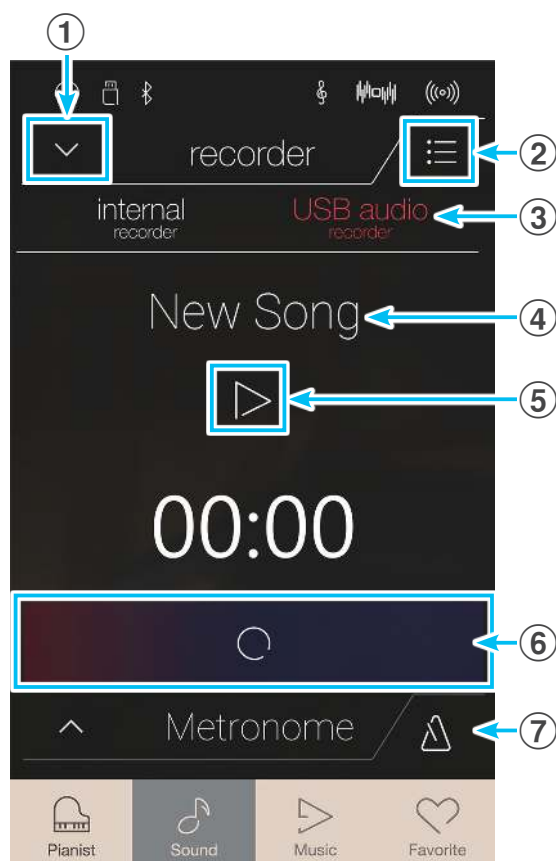

■ USB memory recorder menu

Tap the [Menu] button to show the USB memory recorder menu.

① Format select

Tap the [MP3] or [WAV] buttons to select the desired audio recorder file format.

* MP3 audio files require less storage space than WAV audio files.

* MP3 audio files will be recorded at a bitrate of 256 kbit/s.

② Gain level

Long press and drag the slider to adjust the volume level (gain) of the recording.

Increasing the gain level may be beneficial when recording quieter pieces of music.

* The gain setting can be adjusted within the range of 0 dB~+15 dB.

* Exercise caution when increasing the gain setting, as higher levels may result in distorted recordings.

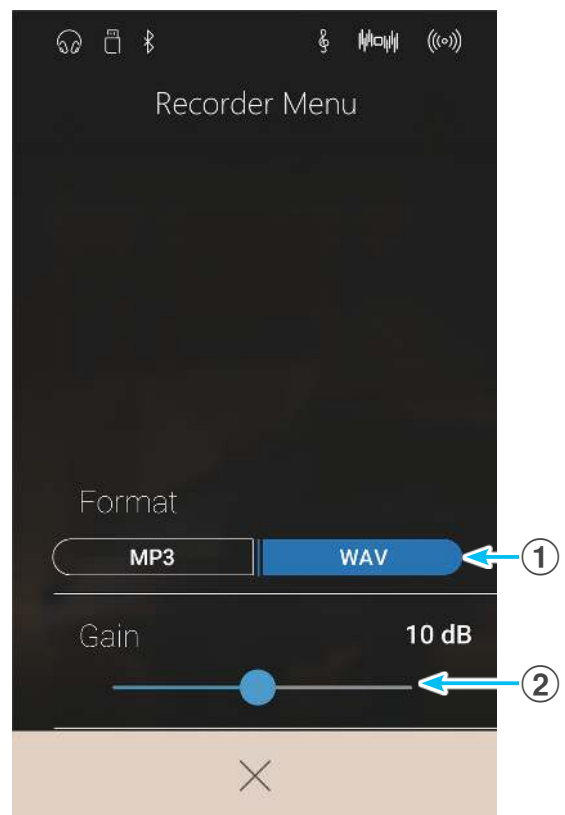

■ Recording a song

1. Tap the [Record Start/Stop] button.

The Recorder will enter Standby mode.

* Press and hold the [Record Start/Stop] button to cancel the Standby mode.

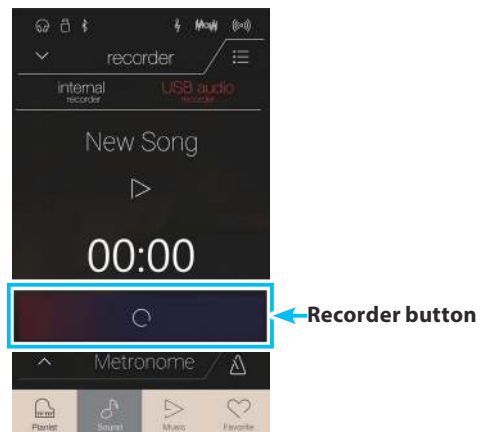

2. Press a key on the keyboard, or tap the [Record Start/Stop] button again.

The [Record Start/Stop] button will change colour, and the recording will start.

The current recording time will also be shown in the LCD display.

* Press the [Metronome Start/Start] button before or during the recording to turn on the metronome. The metronome 'click' sound will not be recorded, however drum patterns will be recorded.

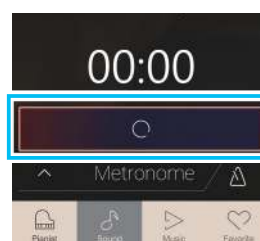

3. Tap the [Record Start/Stop] button again to stop the recording.

A confirmation box will be shown prompting to save the file to USB memory.

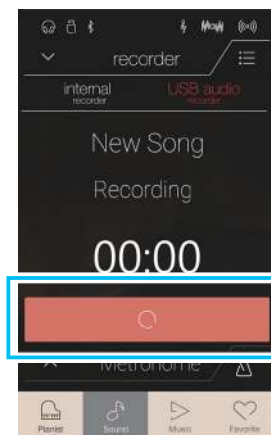

4. Tap [Yes], then enter the desired filename for the recorded audio file using the onscreen keyboard.

* The recorded audio file will be saved in the root folder of the USB memory device. It is not possible to save the file in a different folder.

* During recording, it will not be possible to alternate between Pianist/Sound modes.

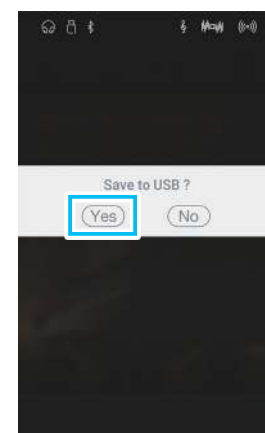

■ Playing the song

1. Tap the [Play/Stop] button.

The previously recorded song will start to play.

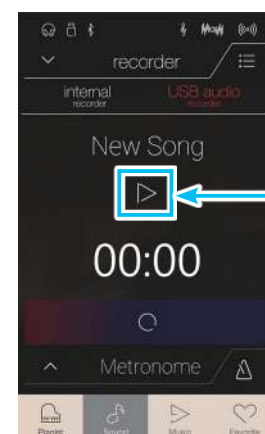

2. Tap the [Play/Stop] button again to stop playback.

* For more information about playing back Recorder songs, please refer to page 69.

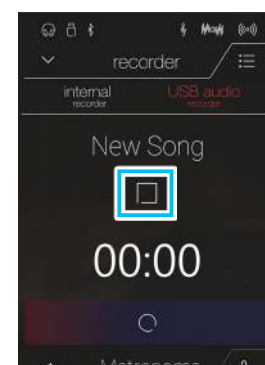

About the Music Screen

The Music screen provides access to the NV10 hybrid digital piano's broad selection of built-in demonstration songs, piano music pieces, and classical and contemporary lesson books. This screen is also used to access the Concert Magic function, to playback recorder songs stored in internal memory, and WAV/MP3 audio files saved to a connected USB memory device.

Tap the [Music] button to show the Music screen.

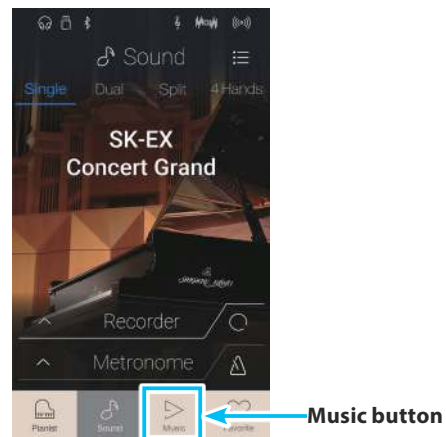

■ Music screen

- ① **Demo Songs**
Tap to enter the Demo Songs function.
This function will play back demo songs for many of the Sound mode instrument sounds.
- ② **Piano Music**
Tap to enter the Piano Music function.
This function will play back a selection of classical music pieces using the Shigeru Kawai SK-EX grand piano sound.
- ③ **Lesson Songs**
Tap to enter the Lesson Songs function.
This function allows aspiring pianists to learn and practise the piano using a selection of classical and contemporary lesson books.
- ④ **Concert Magic**
Tap to enter the Concert Magic function.
This function allows non-pianists to enjoy playing a selection of pieces by tapping the keyboard with a steady rhythm
- ⑤ **Recorder Playback**
Tap to enter the Recorder Playback function.
This function allows recorder songs stored in internal memory to be played back.
- ⑥ **USB Memory Player**
Tap to enter the USB Memory Player function.
This function allows audio files saved to a connected USB memory device to be played back.

* This function will only be visible when a USB memory device is connected to the NV10 hybrid digital piano.

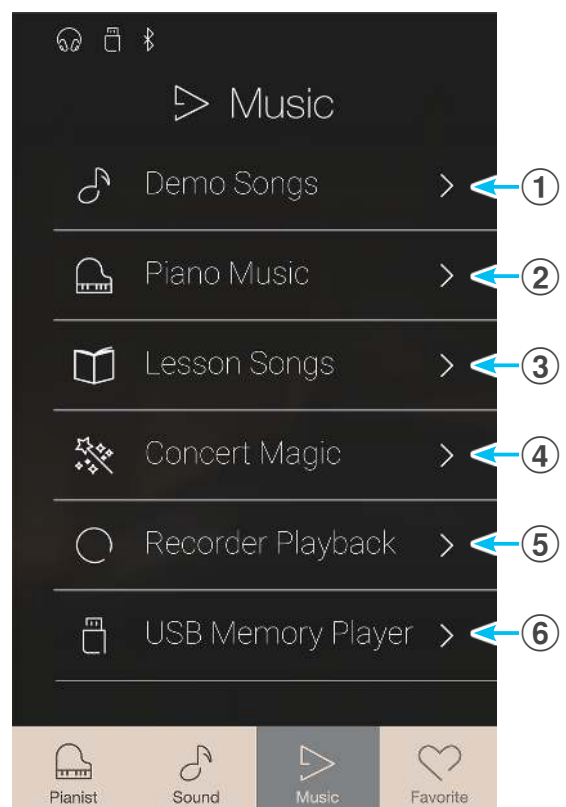

Demo Songs

The Demo Songs function provides an excellent introduction to the varied capabilities of NV10 hybrid digital piano. There are over 35 different demonstration songs available, highlighting the instrument's rich selection of high quality sounds and its power speaker system.

For a complete listing of demonstration songs, please refer to page 160 of this owner's manual.

From the Music screen, tap [Demo Songs] to enter the function.

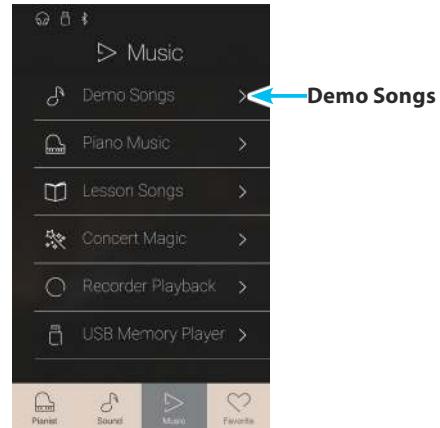

■ Demo Songs screen

① Back button

Tap to return to the Music screen.

② Demo songs list

Tap an instrument sound to select the demo song for playback.
Swipe up or down to scroll through the list of demo songs.

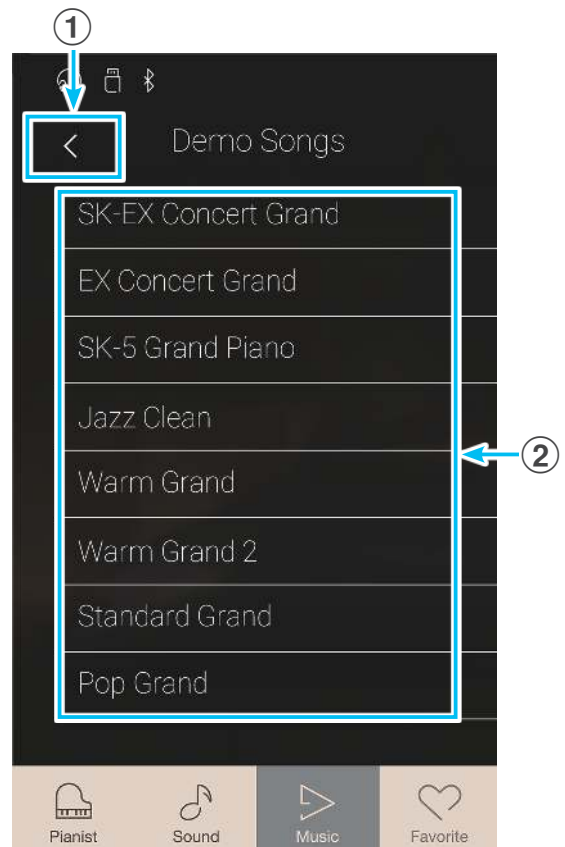

Demo Songs

■ Selecting a demo song

Tap an instrument sound name to select the demo song for playback.

The demo song playback screen will be shown, and the selected song will begin to play.

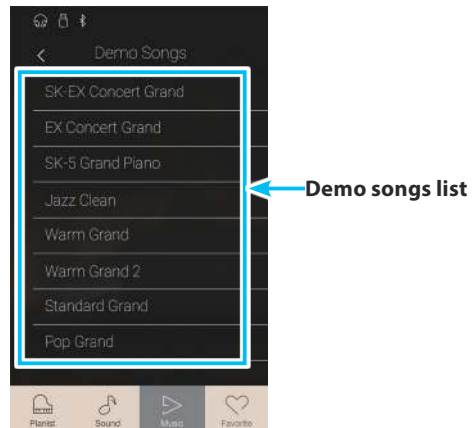

■ Demo song playback screen

① Back button

Tap to return to the Demo Songs screen.

② Sound name

Displays the instrument sound name of the currently selected demo song.

③ Previous button

Tap to select the previous demo song for playback.

④ Play/Stop button

Tap to Play/Stop the selected demo song.

⑤ Next button

Tap to select the next demo song for playback.

* When the selected song has finished, the next demo song in the same demo category will begin to play automatically. When all songs in the category have been played, the first song in another category selected at random will be played automatically.

* While a song/piece is playing, selecting the Pianist or Sound modes will cause playback to stop.

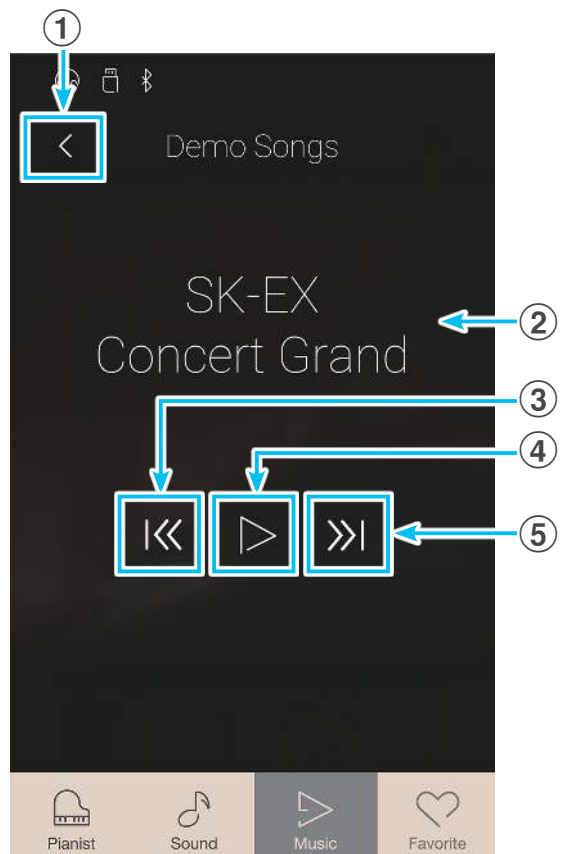

Piano Music

In addition to the sound demonstration songs, the NV10 hybrid digital piano also features a selection of popular classical piano works from the Baroque and Romantic periods. Notated scores are provided in the separate 'Classical Piano Collection' book*, assisting the musical appreciation and study of each piece.

* Depending on market area.

For a complete listing of Piano Music pieces, please refer to the separate 'Internal Song Lists' booklet.

From the Music screen, tap [Piano Music] to enter the function.

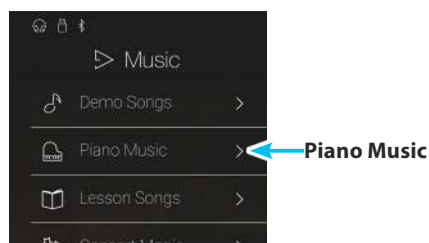

■ Piano Music screen

① Back button

Tap to return to the Music screen.

② Piano Music pieces list

Tap a Piano Music title to select the piece for playback.
Swipe up or down to scroll through the list of Piano Music pieces.

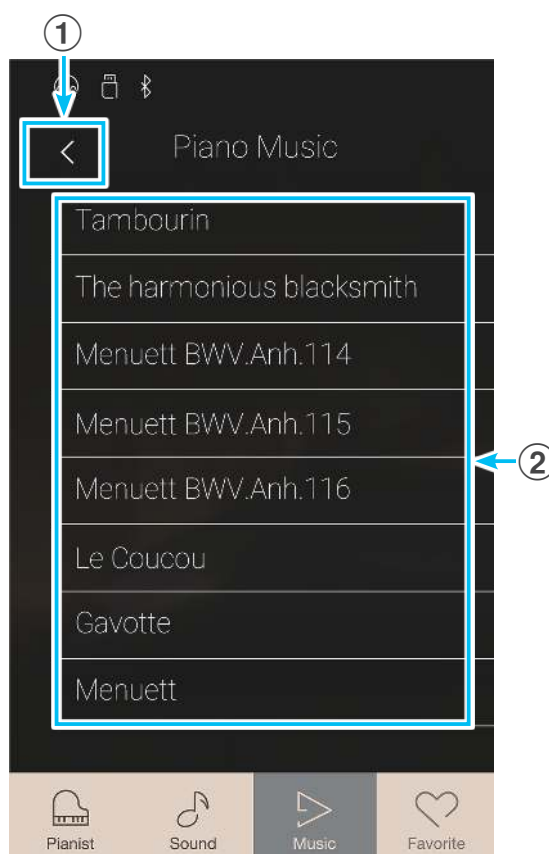

■ Selecting a Piano Music piece

Tap a Piano Music piece to select the piece for playback.

The Piano Music playback screen will be shown, and the selected piece will begin to play.

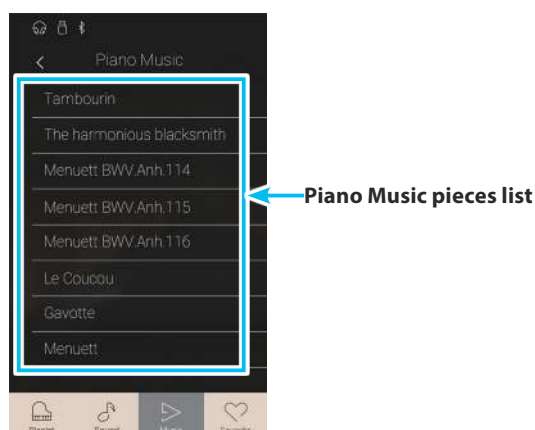

■ Piano Music playback screen

- ① **Back button**
Tap to return to the Piano Music songs screen.
- ② **Piano Music menu button**
Tap to open the Piano Music settings menu.
- ③ **Piece title**
Displays the title of the currently selected Piano Music piece.
- ④ **Previous button**
Tap to select the previous Piano Music piece for playback.
- ⑤ **Play/Stop button**
Tap to Play/Stop the selected Piano Music piece.
- ⑥ **Next button**
Tap to select the next Piano Music piece for playback.

- * When the selected Piano Music piece has finished, the next piece will begin to play automatically.
- * While a song/piece is playing, selecting the Pianist or Sound modes will cause playback to stop.

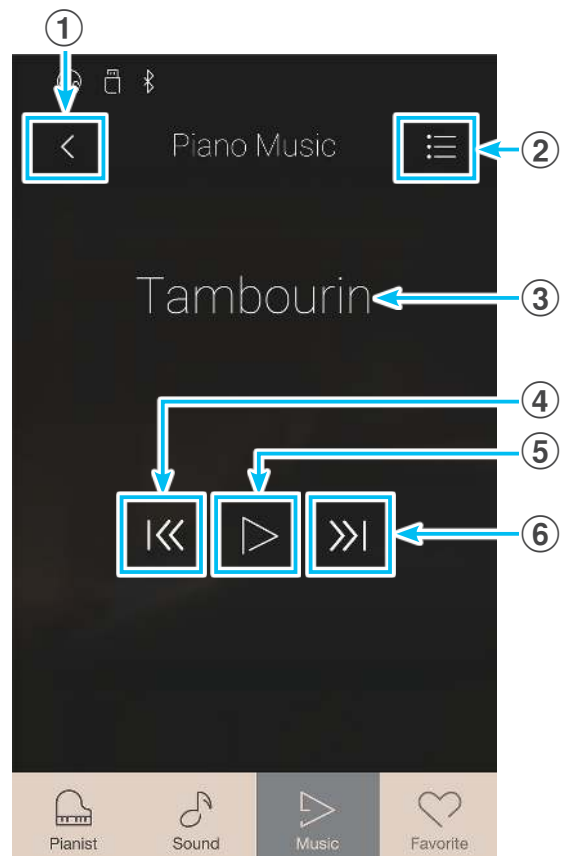

■ Piano Music settings menu

- ① **Balance**
Long press and drag the slider to adjust the volume balance between the right-hand and left-hand parts of the selected Piano Music piece.

* Availability of the Piano Music Balance function is dependent on market location.
- ② **Close Menu**
Tap to close the menu and return to the Piano Music playback screen.

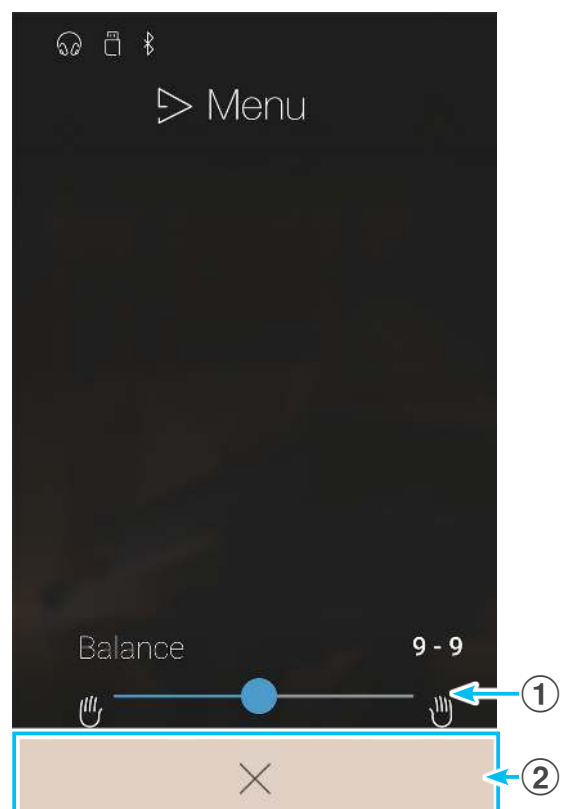

Lesson Songs

The Lesson Songs function allows budding pianists to practice the piano using a selection of built-in song books and finger exercises. The left and right-hand parts of each piece can be practiced separately, while the tempo can also be adjusted to perfect difficult passages.

For a complete listing of the built-in lesson material, please refer to the separate 'Internal Song Lists' booklet.

From the Music screen, tap [Lesson Songs] to enter the function.

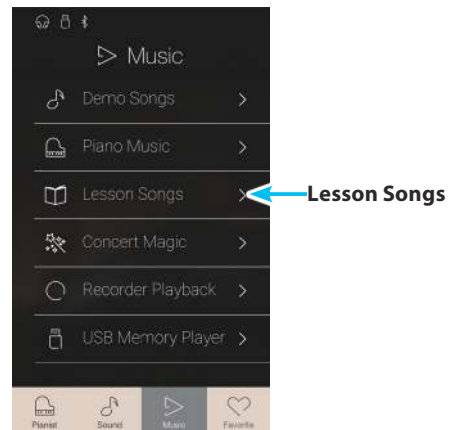

■ Built-in Lesson Song Books

Alfred Lesson Books

- Alfred's Premier Piano Course Lesson 1A
- Alfred's Premier Piano Course Lesson 1B
- Alfred's Basic Piano Library Lesson Book Level 1A
- Alfred's Basic Piano Library Lesson Book Level 1B
- Alfred's Basic Adult Piano Course Lesson Book Level 1

* Lesson books sold separately – please refer to the separate 'Internal Song Lists' booklet for more information.

Classical Lesson Books

- Burgmüller 25 (25 Etudes Faciles, Opus 100)
- Czerny 30 (Etudes de Mécanisme, Opus 849)
- Czerny 100 (Hundert Übungsstücke, Opus 139)
- Beyer 106 (Vorschule im Klavierspiel, Opus 101)
- J.S. Bach: Inventionen
- Sonatinen Album 1
- Chopin Walzer (Chopin waltzes series 1-19)
- Chopin Etüden (Opus 10 Urtext)
- Finger exercises (scales, arpeggios, chords)

Lesson Songs

■ Lesson Song screen

① Back button

Tap to return to the Music screen.

② Lesson Song book list

Tap a lesson song book to select the book for practise.
Swipe up or down to scroll through the list of lesson song books.



■ Selecting a lesson book and song/piece

1. Tap a lesson song book to select the book.

A list of songs/pieces from the selected lesson book will be shown.

2. Tap a lesson song/piece to select the song/piece for practice.

The Lesson Song playback screen will be shown.

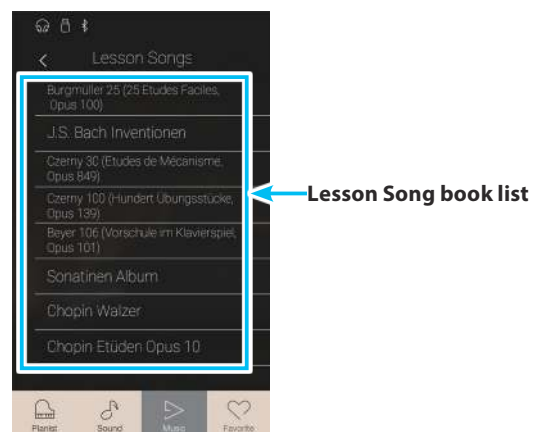

■ Lesson Song playback screen

- ① **Back button**
Tap to return to the Lesson Song book screen.
- ② **Lesson Song menu button**
Tap to open the Lesson Song settings menu.
- ③ **Song/Piece title**
Displays the title of the currently selected lesson song/piece.
- ④ **Bar/Beat indicator**
Displays the bar and beat of the currently playing lesson song/piece.
Swipe left or right to adjust the playback position.
- ⑤ **Playback mode button**
Tap to change the playback mode.

* For more information about Lesson Song playback modes, please refer to the explanation below.
- ⑥ **Previous button**
Tap to select the previous lesson song/piece.
- ⑦ **Play/Stop button**
Tap to Play/Stop the selected lesson song/piece.
- ⑧ **Next button**
Tap to select the next lesson song/piece.
- ⑨ **A-B Repeat button**
Repeat a section of the selected lesson song/piece between points A and B.
Tap to set the A (start) and B (end) points of the phrase to be repeated.

* Tap the A-B button for a third time to turn off the A-B repeat function.
- ⑩ **Metronome bar / Metronome Start/Stop button**
Tap to open the Metronome settings and/or Start/Stop the metronome.

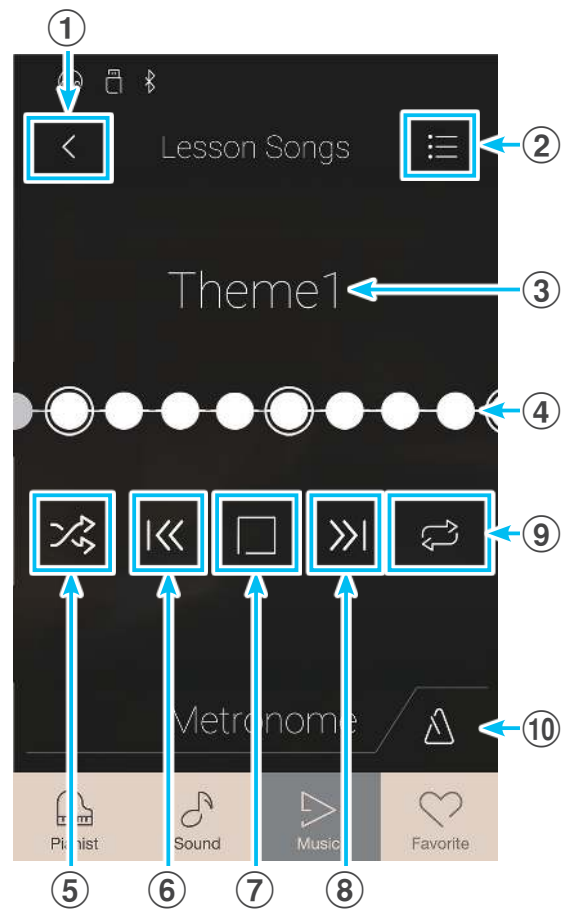

* While a song/piece is playing, selecting the Pianist or Sound modes will cause playback to stop.

Lesson Song settings menu

- ① **Balance**
Long press and drag the slider to adjust the volume balance between the right-hand and left-hand parts of the selected lesson song/piece.
- ② **Close Menu**
Tap to close the menu and return to the Lesson Song playback screen.

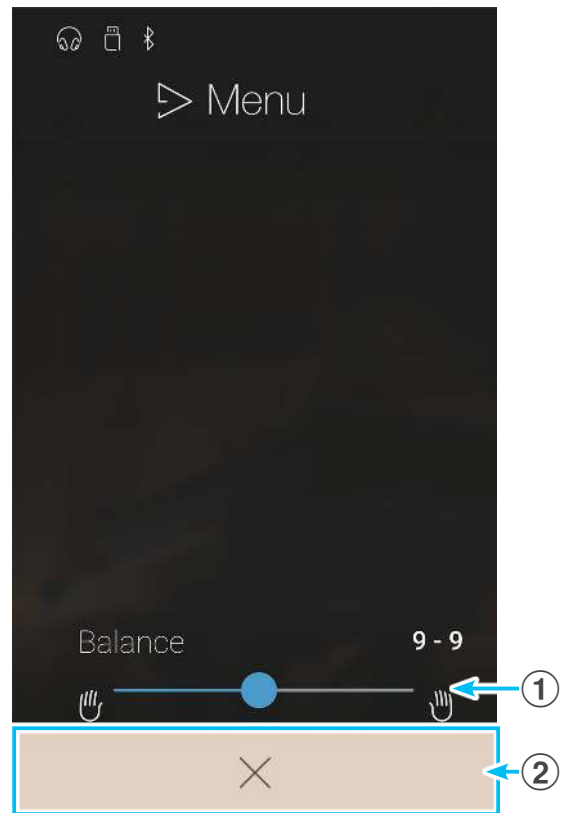

Playing the selected lesson song/piece

1. Tap the [Play/Stop] button.
Following a 1 bar count-in, the lesson song/piece will start to play. The bar/beat indicator will scroll to indicate the current playing position.

2. Swipe the bar/beat indicator left or right to adjust the playback position.

3. Tap the [Play/Stop] button.

The lesson song/piece will stop playing.

4. Tap the [Play/Stop] button again.



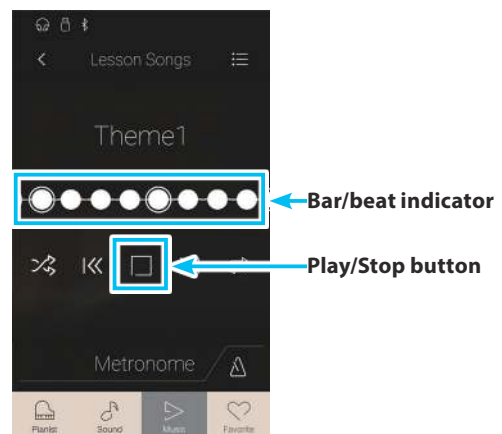

The lesson song/piece will resume playback from 2 bars before the stop position.

* While a song/piece is playing, selecting the Pianist or Sound modes will cause playback to stop.



■ Changing the lesson song playback mode

Tap the playback mode button to change the lesson song playback mode.

-  Play the selected song/piece once, then stop.
-  Play the selected song/piece repeatedly.
-  Play the selected song/piece, then play other songs from the current lesson book in order.
-  Play the selected song/piece, then play another song from the current lesson book at random.

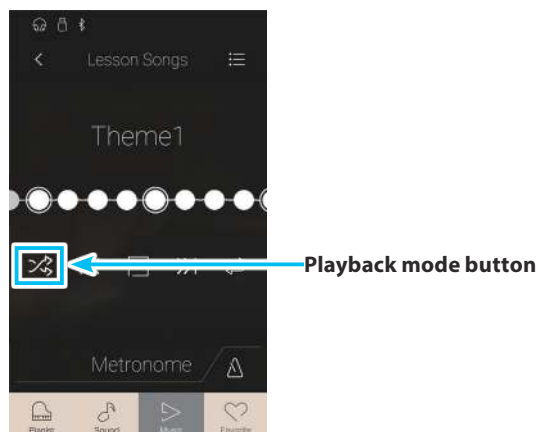

■ Repeating a section of the lesson song/piece (A-B Repeat)

The A-B Repeat function allows sections of the selected lesson song/piece to be 'looped' between two points in order to practise difficult passages continuously.

While the lesson song/piece is playing:

1. Tap the [A-B Repeat] button to specify the start point of the loop.

An 'A' symbol will appear above the button.

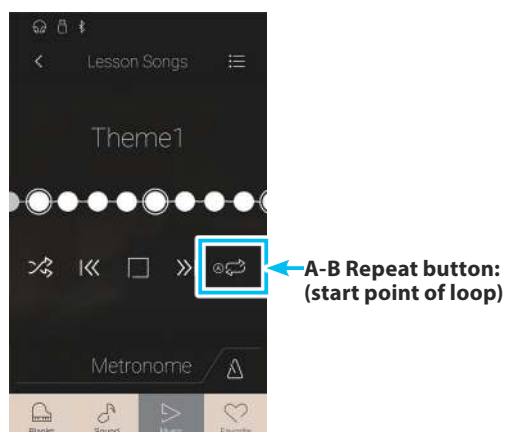

2. Tap the [A-B Repeat] button again to specify the end point of the loop.

A 'B' symbol will appear above the button, and the defined section will be repeated continuously.

* The repeat will begin two measures before the defined 'A' point.

3. Tap the [A-B Repeat] button again to cancel the repeat function.

The lesson song/piece will resume normal playback.

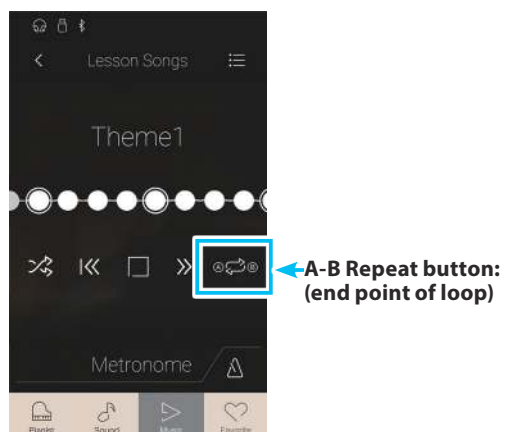

■ Adjusting the lesson song/piece playback tempo

It is possible to adjust the playback tempo of the current lesson song/piece, allowing difficult passages to be practised more conveniently.

1. Tap the [Open Metronome] button to expand the Metronome bar.

2. Swipe each digit up/down or tap the arrow buttons to adjust the lesson song/piece playback tempo.

* It is also possible to turn the metronome on/off to assist with timing.

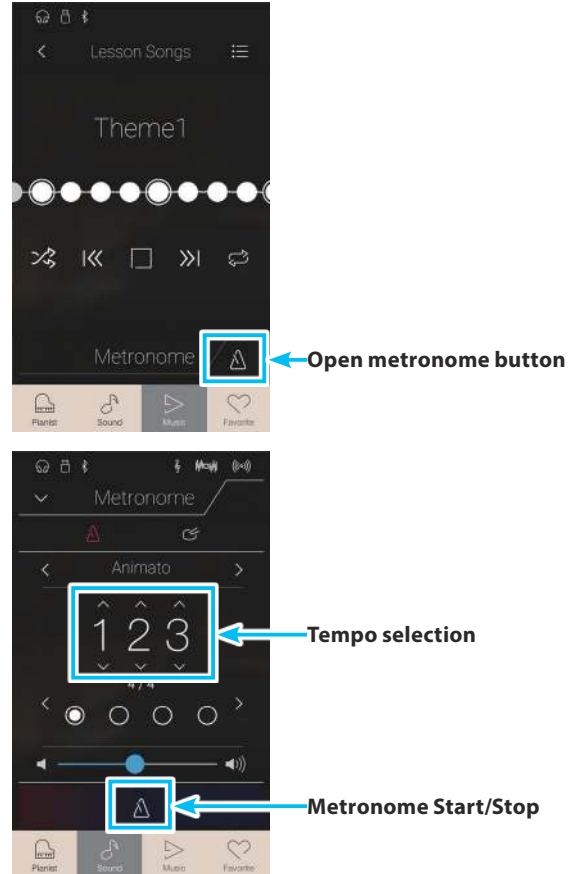

■ Adjusting the lesson song balance

It is also possible to adjust the volume balance between the right-hand and left-hand parts of the current lesson song/piece, allowing each hand to be practiced separately.

While the lesson song/piece is playing:

1. Tap the [Menu] button to show Lesson Song menu.
2. Long press and drag the Balance slider to the left-most position (9-1).

The right-hand part of the selected lesson song/piece will be muted, allowing this part to be practiced.

3. Long press and drag the Balance slider to the right-most position (1-9).

The left-hand part of the selected lesson song/piece will be muted, allowing this part to be practiced.

* If the Beyer lesson book is selected, increasing the left-hand value will decrease the volume of the student's part, while increasing the right-hand value will decrease the volume of the teacher's part.

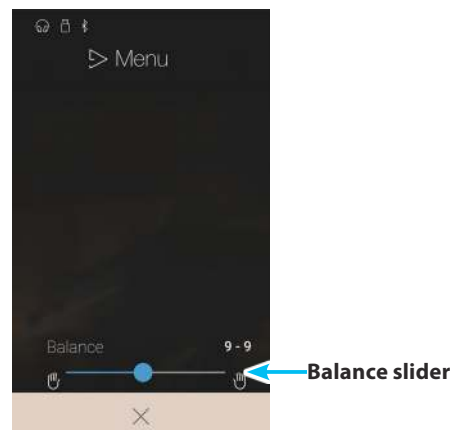

Concert Magic

The Concert Magic function allows complete beginners to enjoy playing the piano by simply selecting one of the 176 pre-programmed songs, then tapping the keyboard with a steady rhythm and tempo.

For a complete listing of available Concert Magic songs, please refer to the separate 'Internal Song Lists' booklet..

From the Music screen, tap [Concert Magic] to enter the function.

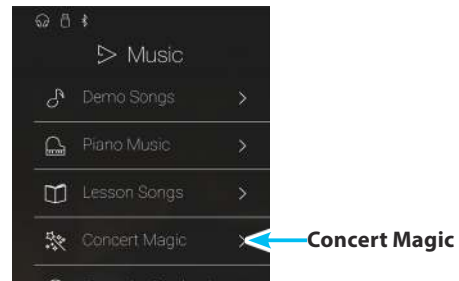

■ Concert Magic screen

① Back button

Tap to return to the Music screen.

② Concert Magic category list

Tap a category to show the available Concert Magic songs in that category.

Swipe up or down to scroll through the list of categories.

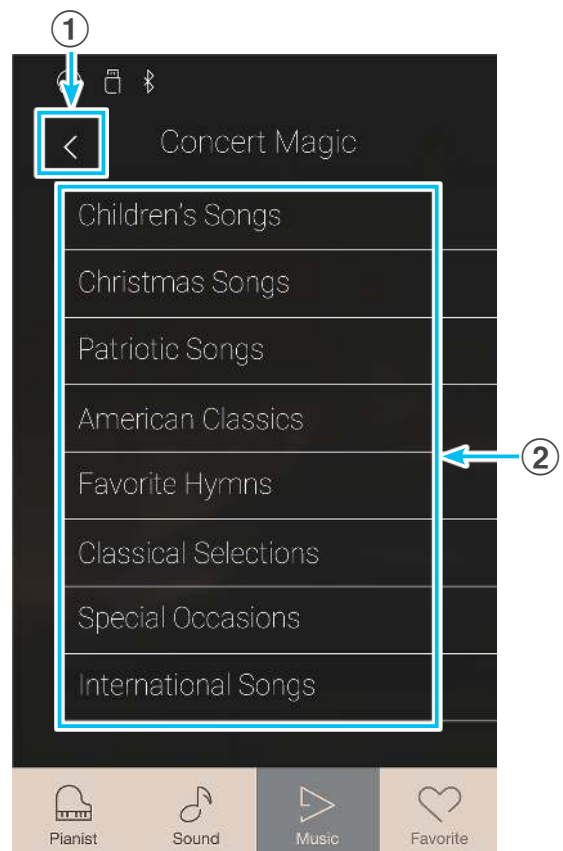

Music Screen

■ Selecting a Concert Magic category and song

1. Tap a Concert Magic category.

A list of songs from the selected category will be shown.

2. Tap a song to select the song for playback/performance.

The Concert Magic playback screen will be shown.

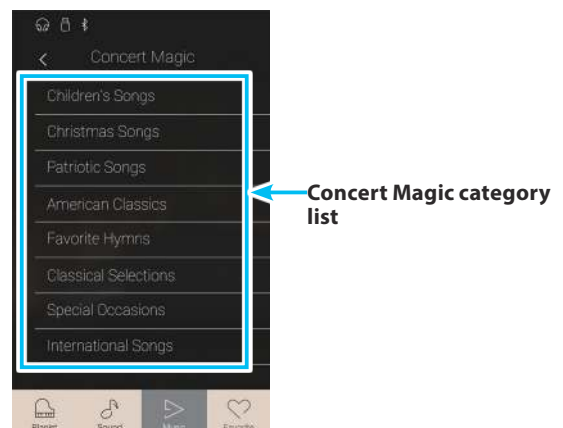

■ Concert Magic playback screen

- ① **Back button**
Tap to return to the Concert Magic categories screen.
- ② **Concert Magic menu button**
Tap to open the Concert Magic settings menu.
- ③ **Song title**
Displays the title of the currently selected Concert Magic song.
- ④ **Playback mode button**
Tap to change the playback mode.

* For more information about Concert Magic playback modes, please refer to the explanation below.
- ⑤ **Previous button**
Tap to select the previous Concert Magic song.
- ⑥ **Play/Stop button**
Tap to Play/Stop the selected Concert Magic song.
- ⑦ **Next button**
Tap to select the next Concert Magic song.
- ⑧ **Performance mode button**
Tap to change the Concert Magic performance mode between 'Normal' and 'Steady Beat' modes.

* For more information about Concert Magic performance modes, please refer to the explanation below.

* While a song/piece is playing, selecting the Pianist or Sound modes will cause playback to stop.

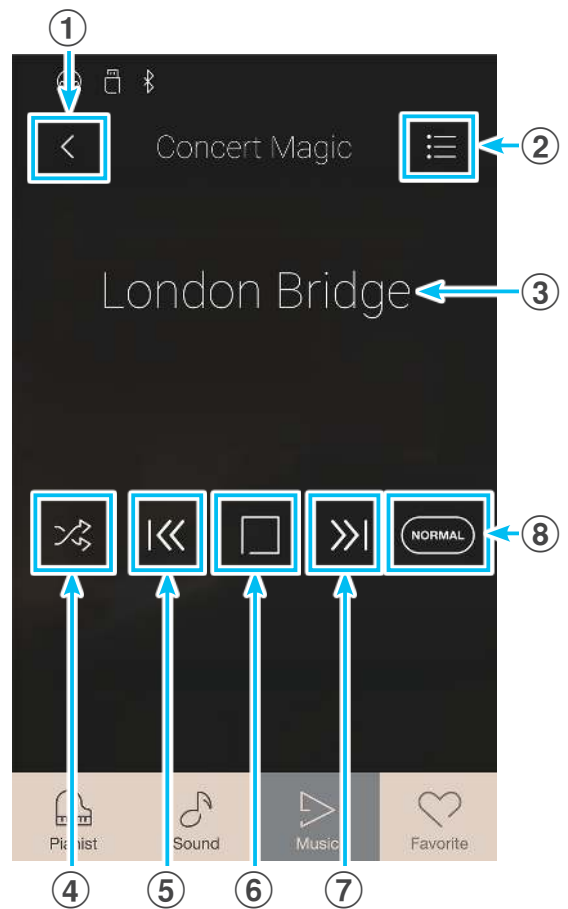

■ Concert Magic settings menu

- ① **Balance**
Long press and drag the slider to adjust the volume balance between the right-hand and left-hand parts of the selected Concert Magic song.
- ② **Tempo**
Swipe each digit up/down or tap the arrow buttons to adjust the Concert Magic song playback tempo.
- ③ **Close Menu**
Tap to close the menu and return to the Concert Magic playback screen.

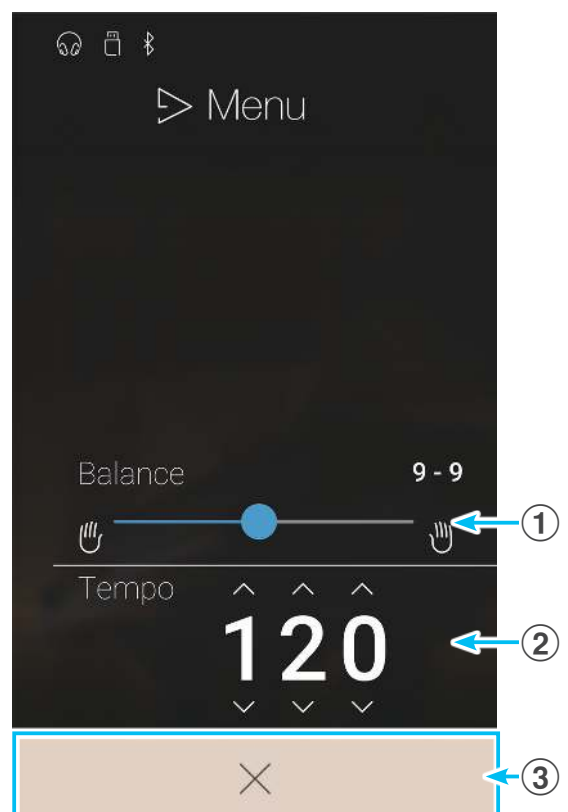

1 Concert Magic song playback

The Concert Magic playback function allows the currently selected song to be played automatically, without pressing the keyboard.

■ Playing the selected Concert Magic song

1. Tap the [Play/Stop] button.

The selected Concert Magic song will start to play.

2. Tap the [Play/Stop] button.

The Concert Magic song will stop playing.

* While a song/piece is playing, selecting the Pianist or Sound modes will cause playback to stop.

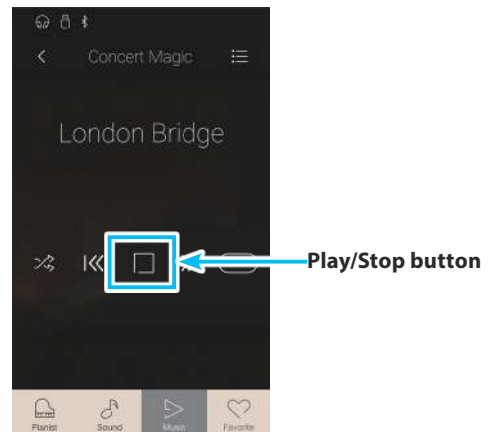

■ Changing the Concert Magic playback mode

Tap the playback mode button to change the Concert Magic playback mode.

- Play the selected song repeatedly.
- Play the selected song, then play other songs from the current category in order.
- Play the selected song, then play another song from the current song group at random.

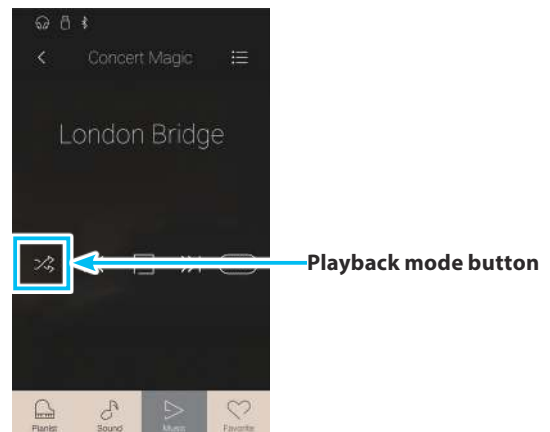

■ Adjusting the Concert Magic song playback tempo

It is possible to adjust the playback tempo of the current Concert Magic song.

1. Tap the [Menu] button to show the Concert Magic settings menu.
2. Swipe each digit up/down or tap the arrow buttons to adjust the Concert Magic song playback tempo.



■ Adjusting the Concert Magic song balance

It is also possible to adjust the volume balance between the right-hand and left-hand parts of the current Concert Magic song, allowing each hand to be practiced separately when using the playback function.

1. Tap the [Menu] button to show the Concert Magic settings menu.

2. Long press and drag the Balance slider to the left-most position (9-1).

The right-hand part of the selected Concert Magic song will be muted, allowing this part to be practiced.

3. Long press and drag the Balance slider to the right-most position (1-9).

The left-hand part of the selected Concert Magic song will be muted, allowing this part to be practiced.

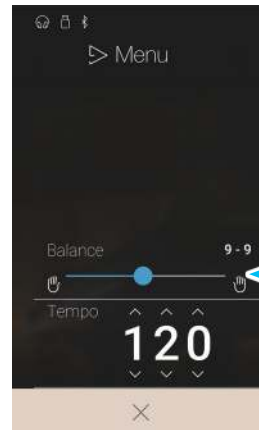

Balance slider

2 Concert Magic song performance

Concert Magic performance function allows the currently selected song to be performed by pressing the keys with a steady rhythm and tempo.

Concert Magic songs are divided into three different arrangement types, each requiring a different level of skill to be performed correctly.

* The Concert Magic arrangement type for each song is indicated in the 'Internal Song Lists' booklet as 'EB', 'MP', or 'SK'.

Easy Beat

EB

These are the easiest songs to play. To perform them, simply tap out a constant steady beat on any key on the keyboard.

The following example shows the notated score for 'Für Elise', indicating that a constant, steady rhythm should be maintained throughout the song. This is the distinguishing characteristic of an Easy Beat song.

Key on: X



The image shows a musical score for 'Für Elise' in 3/8 time. Above the staff, a sequence of 'X' marks indicates a steady, constant rhythm. The score consists of two staves: a treble clef staff with a melody and a bass clef staff with accompaniment. The melody is a simple, rhythmic line, and the accompaniment consists of chords and single notes that maintain the same steady beat.

Melody Play

MP

These songs are also relatively easy to play, especially if they are familiar to the player. To perform them, tap out the rhythm of the melody on any key of the keyboard. Singing along as the rhythm is tapped can be helpful.

The following example shows the notated score for 'Twinkle, Twinkle, Little Star'.

* When performing fast Concert Magic songs, it may be easier to tap different keys with two alternating fingers in order to play at a greater speed.

Key on: X X X X X X X X X X X X X X X



The image shows a musical score for 'Twinkle, Twinkle, Little Star' in C major, 4/4 time. Above the staff, a sequence of 'X' marks indicates a steady rhythm. The score consists of two staves: a treble clef staff with a melody and a bass clef staff with accompaniment. The melody is a simple, rhythmic line, and the accompaniment consists of chords and single notes that maintain the same steady beat.

Skillful

SK

These songs range in difficulty from moderately difficult to difficult. To perform them, tap out the rhythm of both the melody and the accompaniment notes on any key of the keyboard. The Note Navigator will be very helpful when playing the Skillful type songs.

The following example shows the notated score for 'Waltz of the Flowers'.

Key on X X X X X X X X X X X X X X X

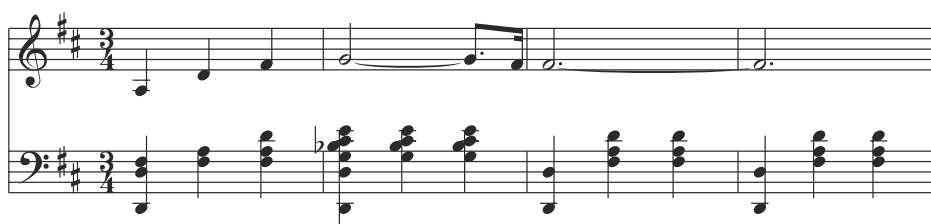

The image shows a musical score for 'Waltz of the Flowers' in 3/4 time. Above the staff, a sequence of 'X' marks indicates a steady rhythm. The score consists of two staves: a treble clef staff with a melody and a bass clef staff with accompaniment. The melody is a simple, rhythmic line, and the accompaniment consists of chords and single notes that maintain the same steady beat.

Concert Magic

■ Performing the selected Concert Magic song

Press a key on the keyboard.

The song will advance with every key that is pressed. Pressing the keys gently will produce a soft sound, while pressing heavily will produce a loud sound.

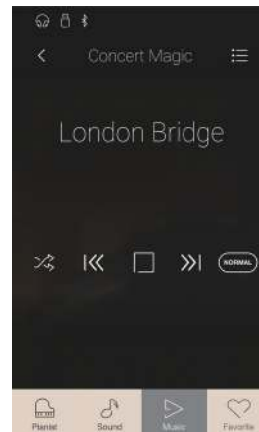

■ Changing the Concert Magic performance mode

Tap the [Performance Mode] button to change the Concert Magic performance mode.

NORMAL Perform the selected Concert Magic song by tapping any key, following the song arrangement type.

STEADY BEAT Perform the selected Concert Magic song by tapping any key with a constant steady beat, regardless of the song arrangement type.

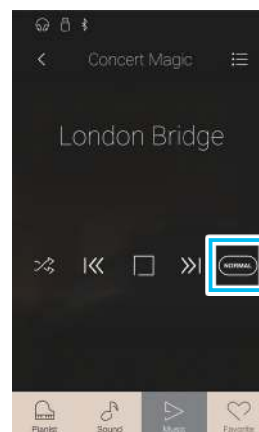

Recorder Playback

The Recorder Playback function is used to playback songs that have been recorded to the instrument's internal memory using Pianist mode or Sound mode.

For more information about the internal song recorder, please refer to page 40.

From the Music screen, tap [Recorder Playback] to enter the function.

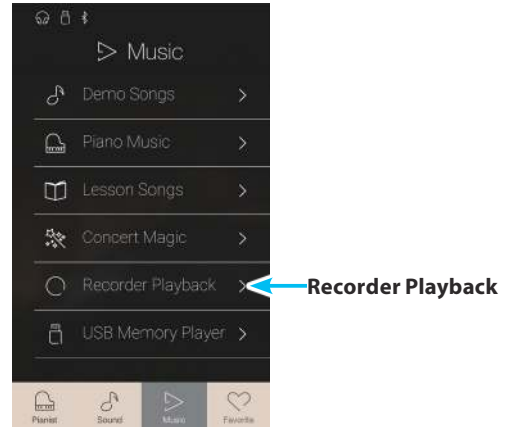

Recorder Playback song selection screen

① Back button

Tap to return to the Music screen.

② Recorder Playback song list

Lists the songs that have been recorded to internal memory.

Tap a song to select it for playback.

Swipe up or down to scroll through the list of internal recorder songs.

The Recorder Playback playback screen will be shown.

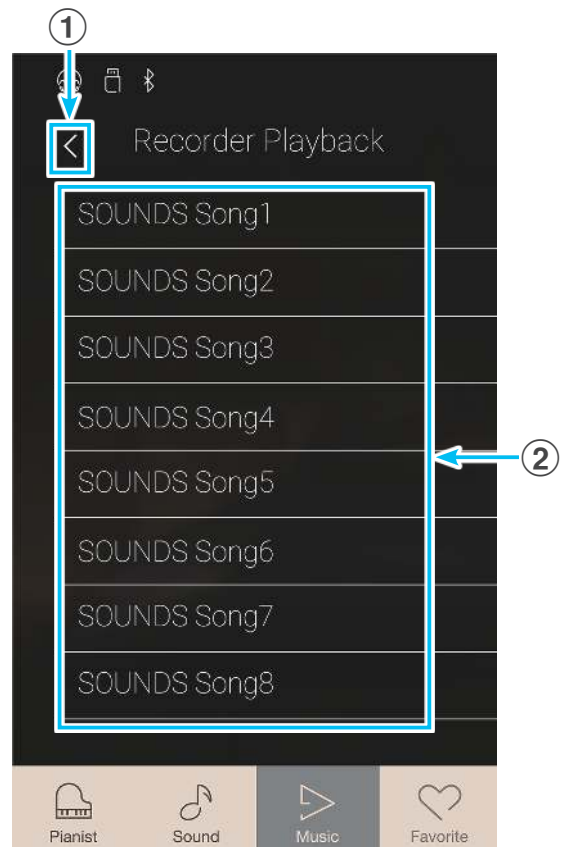

Recorder Playback

■ Recorder Playback playback screen

- ① **Back button**
Tap to return to the Recorder Playback song selection screen.
- ② **Recorder Playback menu button**
Tap to open the Recorder Playback settings menu.
- ③ **Song title**
Displays the title of the currently selected internal recorder song.
- ④ **Position bar**
Displays the current playback position of the selected internal recorder song.
- ⑤ **Previous button**
Tap to select the previous internal recorder song.
- ⑥ **Play/Stop button**
Tap to Play/Stop the selected internal recorder song.
- ⑦ **Next button**
Tap to select the next internal recorder song.
- ⑧ **Recorder bar / Recorder Start/Stop button**
Tap to open the Recorder settings and/or Start/Stop the recorder.

* For more information about the Recorder function, please refer to page 39.
- ⑨ **Metronome bar / Metronome Start/Stop button**
Tap to open the Metronome settings and/or Start/Stop the metronome.

* For more information about the Metronome function, please refer to page 36.

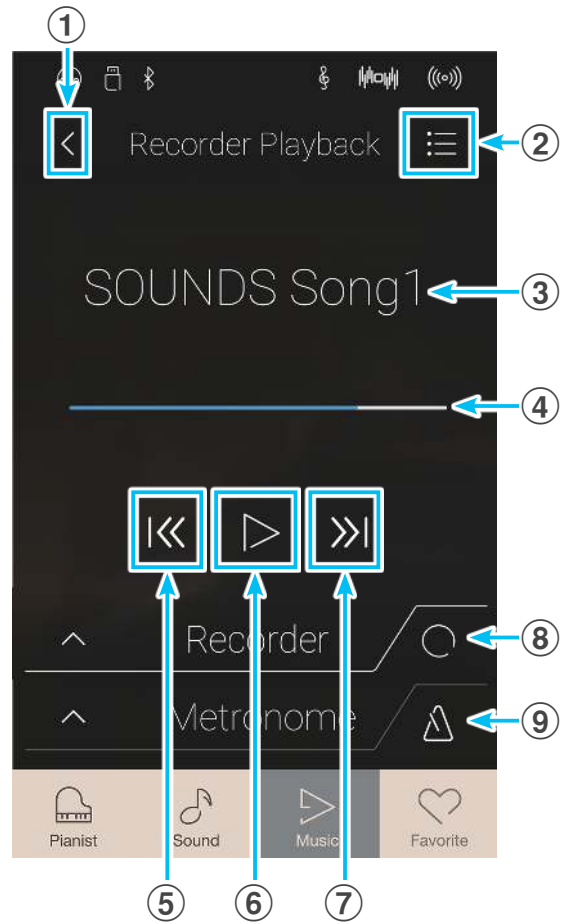

* While a song/piece is playing, selecting the Pianist or Sound modes will cause playback to stop.

Recorder Playback settings menu

① Part Select

Swipe left/right or tap the arrow buttons to select the part(s) of the song to be played back.

* This setting applies to internal songs recorded in Sound mode only.

② Song Transpose

Long press and drag the slider to adjust the playback pitch of the currently selected internal song in semi-tone steps.

* This setting applies to internal songs recorded in Sound mode only.

③ Save to USB (INT)

Tap to save the currently selected internal song to USB memory in Kawai internal (KSO) format.

* This function applies to internal songs recorded in Sound mode only.

④ Save to USB (SMF)

Tap to save the currently selected internal song to USB memory in Standard MIDI File (SMF) format.

* This function applies to internal songs recorded in Sound mode only.

⑤ Load Song from USB

Tap to load a Kawai KSO format song saved to a USB memory device into one of the instrument's internal song memories.

⑥ Erase Song

Tap to erase the currently selected recorder song from internal memory.

⑦ Erase All Songs

Tap to erase all recorded songs from internal memory.

⑧ Close Menu

Tap to close the menu and return to the Recorder Playback playback screen.

* The Save/Load functions will only be visible when a USB memory device is connected to the NV10 hybrid digital piano.

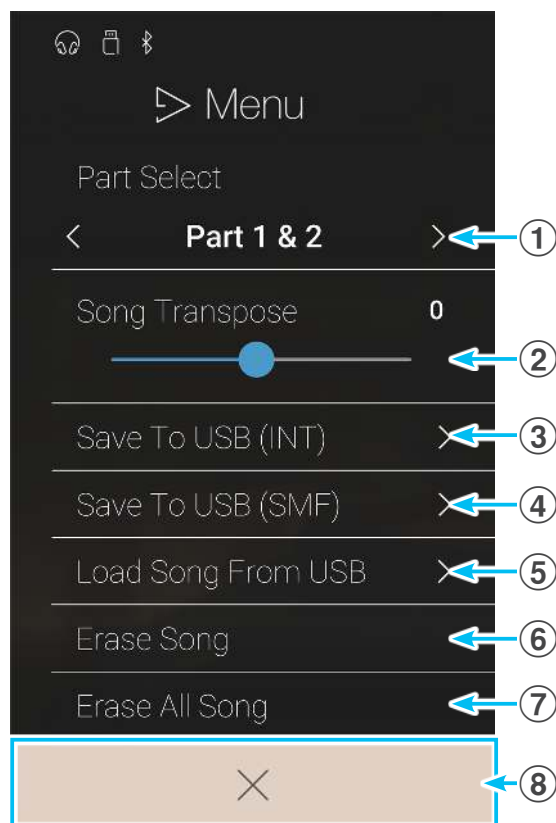

Playing the selected internal recorder song

1. Tap the [Play/Stop] button.

The selected internal recorder song will start to play.

2. Tap the [Play/Stop] button.

The selected internal recorder song will stop playing.

* While a song/piece is playing, selecting the Pianist or Sound modes will cause playback to stop.

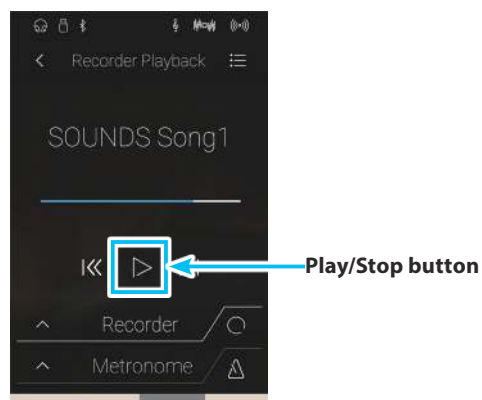

Recorder Playback

■ Playing/muting parts of the song

When playing songs recorded in Sound mode, this setting allows the playback part to be changed.

1. Tap the [Menu] button to show Recorder Playback settings menu.
2. Swipe left/right or tap the arrow buttons to select which part(s) of the song to be played back.

* This setting applies to internal songs recorded in Sound mode only.

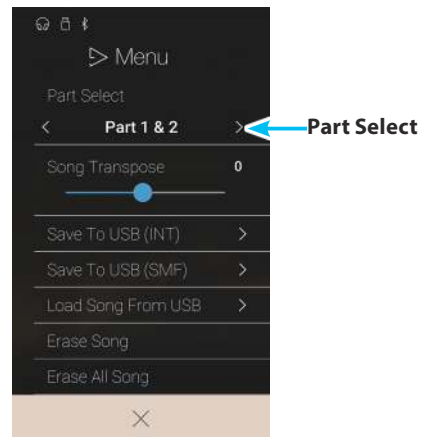

■ Transposing the song

When playing songs recorded in Sound mode, this setting allows the playback pitch to be changed.

1. Tap the [Menu] button to show Recorder Playback settings menu.
2. Long press and drag the slider to adjust the playback pitch of the currently selected internal song in semi-tone steps.

* This setting applies to internal songs recorded in Sound mode only.

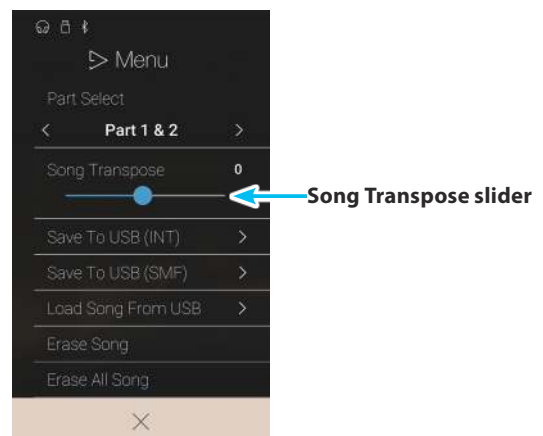

■ Saving the song to USB memory

When playing songs recorded in Sound mode, these functions allow the currently selected song to be saved to USB memory in internal Kawai (KSO) or Standard MIDI File (SMF) formats.

1. Tap the [Menu] button to show Recorder Playback settings menu.
2. Tap [Save to USB (INT)] or [Save to USB (SMF)] functions save the currently selected song in internal or SMF formats.

A filename input screen will appear.

3. Enter the desired filename for the saved song using the onscreen keyboard, then tap the enter key to confirm the save.

* The filename length is limited to 12 characters.

* These functions apply to internal songs recorded in Sound mode only.

* These functions will only be visible when a USB memory device is connected to the NV10 hybrid digital piano.

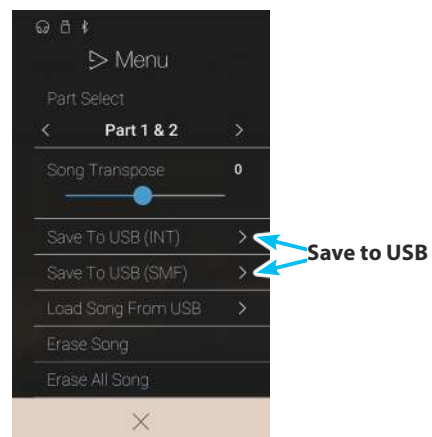

■ Loading a song into internal memory

This function allows NV10 recorder songs (KSO format) stored on a USB memory device to be loaded into the instrument's internal memory.

1. Tap the [Menu] button to show Recorder Playback settings menu.
2. Tap the [Load Song to USB] function.

The internal song memory list will be shown (10 memories).

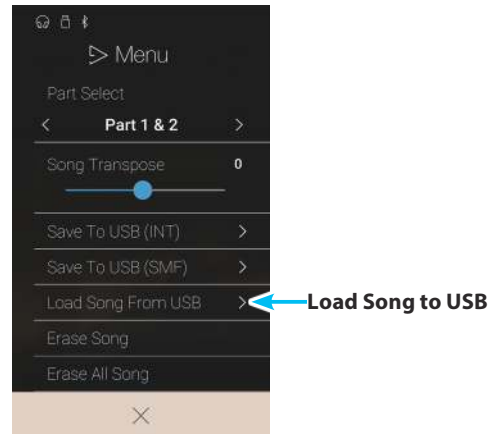

3. Tap the internal song memory for the song to be loaded into.

A list of files and folders stored on the USB memory device will be shown.

4. Tap the filename of the song to be loaded into the selected internal memory.

A confirmation box will be shown.

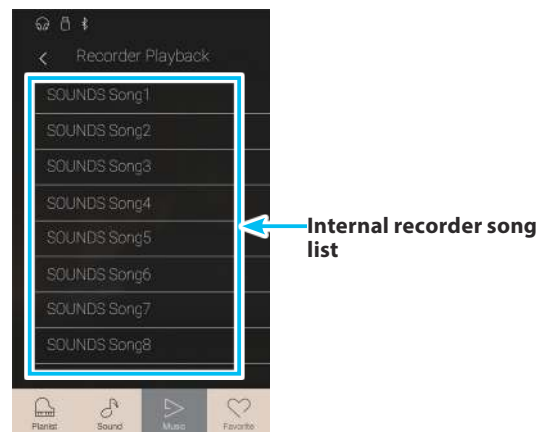

5. Tap the [Yes] button to load the song into the selected internal memory, or the [No] button to cancel.

It should now be possible to play the loaded song via the playback screen.

- * This function applies to internal songs recorded in Sound mode only.
- * This function will only be visible when a USB memory device is connected to the NV10 hybrid digital piano.

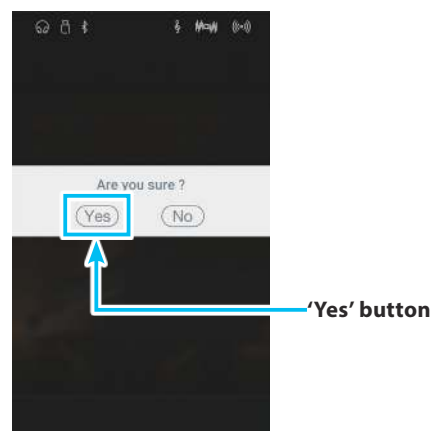

Recorder Playback

Erasing the song

This function allows the current internal recorder song to be erased from memory.

1. Tap the [Menu] button to show Recorder Playback settings menu.
2. Tap [Erase Song].

A confirmation box will be shown.

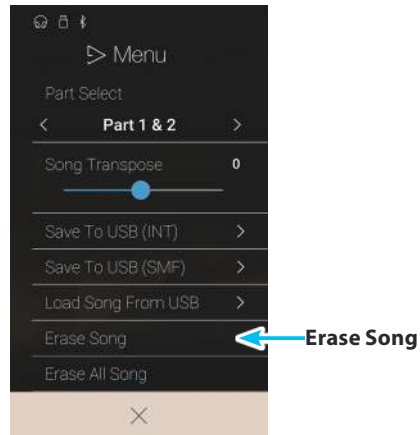

3. Tap the [Yes] button to erase the song, or the [No] button to cancel.

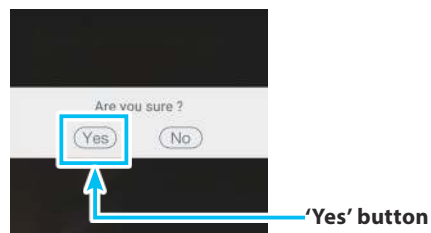

Erasing all songs

This function allows all recorder songs to be erased from internal memory.

1. Tap the [Menu] button to show Recorder Playback settings menu.
2. Tap [Erase All Songs].

A confirmation box will be shown.

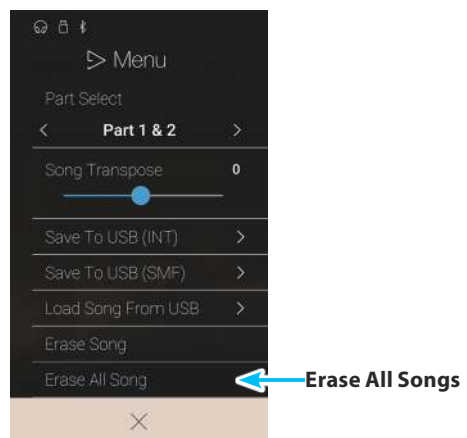

3. Tap the [Yes] button to erase all of the recorder songs stored in internal memory, or the [No] button to cancel..

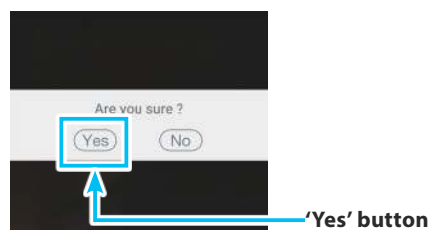

USB Memory Player

The USB Memory Player function is used to playback songs and audio files stored on a USB memory device. This function is particularly useful when attempting to learn the chords or melody to a new piece, or to simply play along with one's favorite song.

* This function will only be visible when a USB memory device is connected to the NV10 hybrid digital piano.

From the Music screen, tap [USB Memory Player] to enter the function.

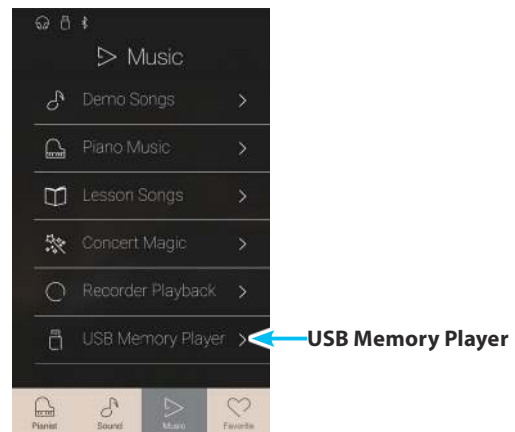

■ USB Memory Player supported formats

Song	KSO	Kawai Song file
	SMF	Format 0, Format 1
Audio	MP3	32 kHz/44.1 kHz/48 kHz, Mono/Stereo, 8-320 kbit/s (fixed & variable)
	WAV	32 kHz/44.1 kHz/48 kHz, Mono/Stereo, 16 bit

■ USB Memory Player song selection screen

① Back button

Tap to return to the Music screen.

② USB Memory file list

Lists the song and audio files stored on the connected USB memory device.

Tap a folder to enter that folder, or tap a song/audio file to select it for playback.

Swipe up or down to scroll through the list of song/audio files.

The USB Memory Player playback screen will be shown.

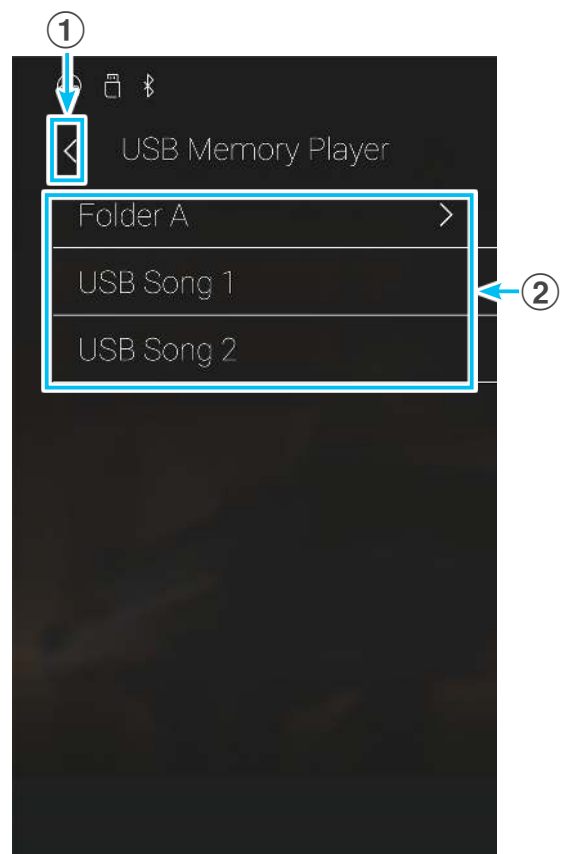

■ USB Memory Player playback screen

- ① **Back button**
Tap to return to the USB Memory Player song selection screen.
- ② **USB Memory Player menu button**
Tap to open the USB Memory Player settings menu.
- ③ **Song/Audio file title**
Displays the title of the currently selected song/audio file.
- ④ **Position bar**
Displays the current playback position of the selected song/audio file.
* For more information about USB Memory Player playback modes, please refer to the explanation below.
- ⑤ **Playback mode button**
Tap to change the playback mode.
* For more information about USB Memory Player playback modes, please refer to the explanation below.
- ⑥ **Previous button**
Tap to select the previous song/audio file in the folder.
- ⑦ **Play/Stop button**
Tap to Play/Stop the selected song/audio file.
- ⑧ **Next button**
Tap to select the next song/audio file in the folder.
- ⑨ **A-B Repeat button**
Repeat a section of the selected song/audio file between points A and B.
Tap to set the A (start) and B (end) points of the phrase to be repeated.
* Tap the A-B button for a third time to turn off the A-B repeat function.
- ⑩ **Recorder bar / Recorder Start/Stop button**
Tap to open the Recorder settings and/or Start/Stop the recorder.
* For more information about the Recorder function, please refer to page 39.
- ⑪ **Metronome bar / Metronome Start/Stop button**
Tap to open the Metronome settings and/or Start/Stop the metronome.
* For more information about the Metronome function, please refer to page 36.

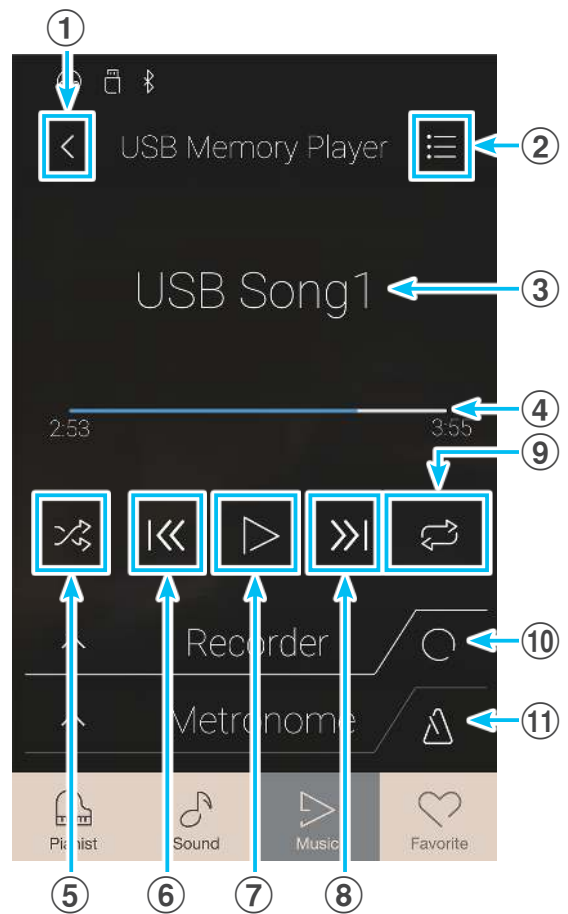

* While a song/audio file is playing, selecting the Pianist or Sound modes will cause playback to stop.

■ Playing the selected song/audio file

1. Tap the [Play/Stop] button.

The selected song/audio file will start to play.
The position bar will indicate the current playing position.

2. Tap the [Play/Stop] button.

The song/audio file will stop playing.

3. Tap the [Play/Stop] button again.



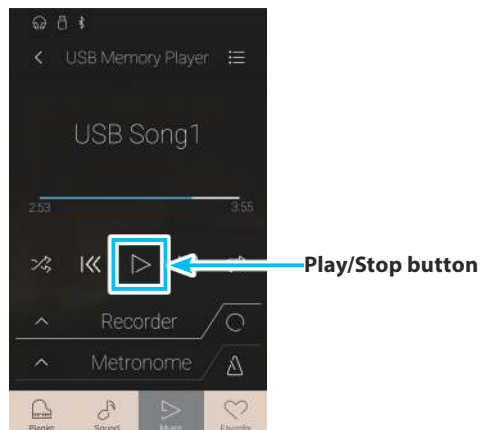

The song/audio will start to play once again, from the beginning.

* While a song/audio file is playing, selecting the Pianist or Sound modes will cause playback to stop.



■ Changing the song/audio file playback mode

Tap the [Playback Mode] button to change the song/audio file playback mode.

-  Play the selected song/audio file once, then stop.
-  Play the selected song/audio repeatedly.
-  Play the selected song/audio, then play other files stored in the same folder in order.
-  Play the selected song/piece, then play other files stored in the same folder at random.

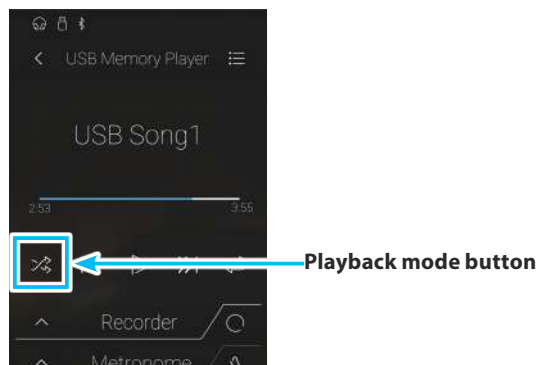

■ Repeating a section of the song/audio file (A-B Repeat)

The A-B Repeat function allows sections of the selected song/audio file to be 'looped' between two points in order to hear the same passage continuously.

While the song/audio file is playing:

1. Tap the [A-B Repeat] button to specify the start point of the loop.

An 'A' symbol will appear above the button.

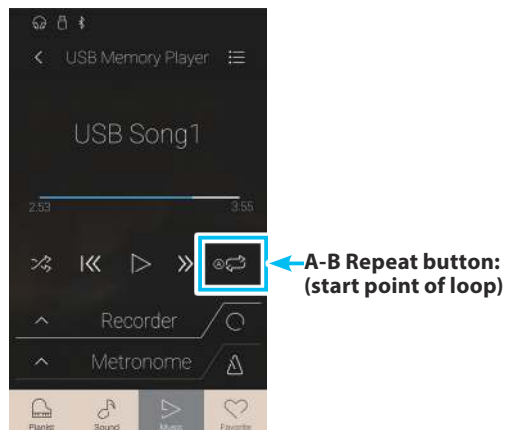

USB Memory Player

2. Tap the [A-B Repeat] button again to specify the end point of the loop.

A 'B' symbol will appear above the button, and the defined section will be repeated continuously.

3. Tap the [A-B Repeat] button again to cancel the repeat function.

The song/audio file will resume normal playback.

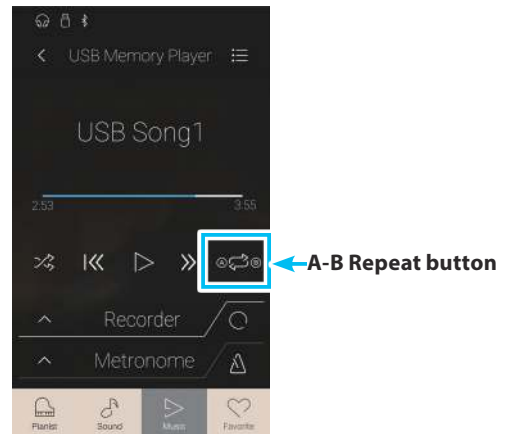

■ USB Memory Player settings menu

① Play Volume

Long press and drag the slider to adjust the playback volume of the currently selected song/audio file.

② Song Transpose

Long press and drag the slider to adjust the playback pitch of the currently selected song/audio file.

* This setting applies to KSO/SMF songs only.

③ Close Menu

Tap to close the menu and return to the USB Memory Player playback screen.

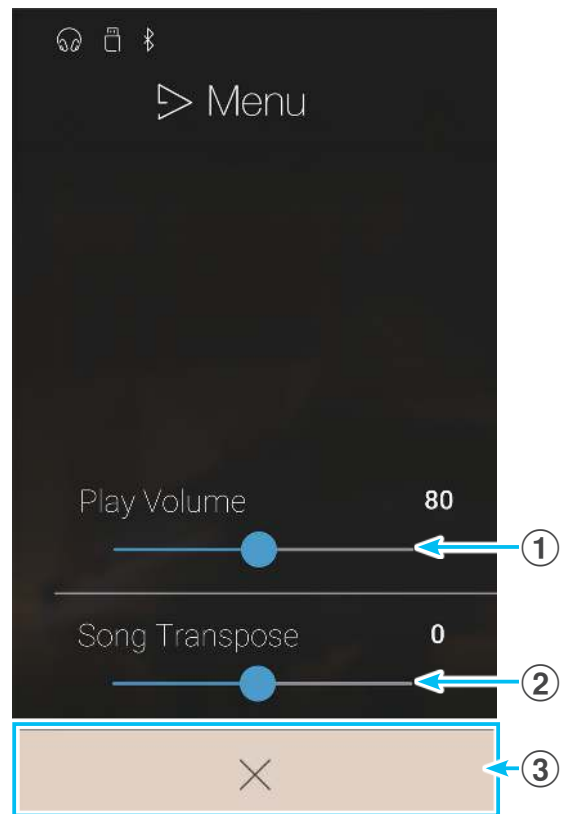

■ Adjusting the volume of the song/audio file.

This setting allows the volume of the song/audio file to be adjusted.

1. Tap the [Menu] button to show USB Memory Player settings menu.
2. Long press and drag the slider to adjust the playback volume of the currently selected song/audio file.

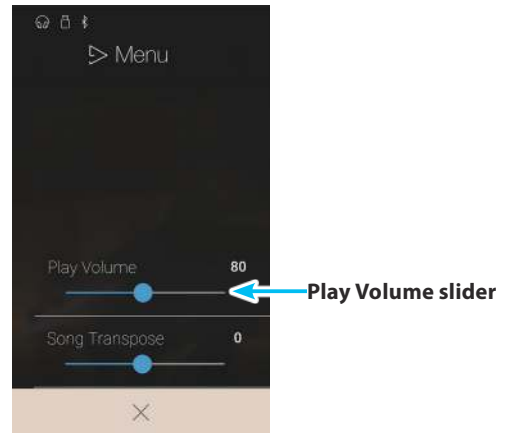

■ Transposing the song file

This setting allows the playback pitch of the song file to be changed.

1. Tap the [Menu] button to show USB Memory Player settings menu.
2. Long press and drag the slider to adjust the playback pitch of the currently selected song/audio file.

* This setting applies to KSO/SMF songs only.

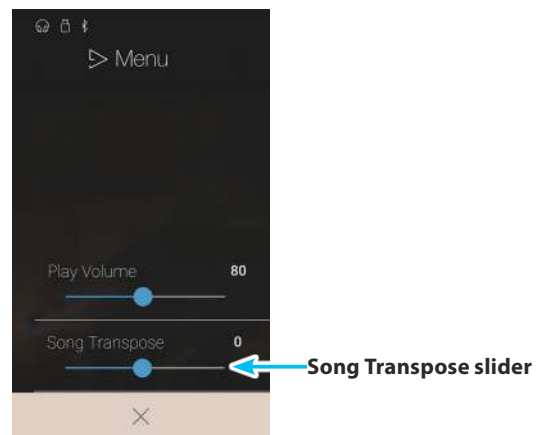

About the Favorite Screen

The Favorite function allows the current instrument setup (sound selections, split point, reverb and effect settings, and various other panel options) to be stored to a memory and immediately recalled with a single tap. The Favorite screen displays 4 memories per page, with a maximum of 4 pages, allowing a total of 16 different Favorite memories to be stored.

The Favorite screen is empty by default, but new Favorite memories can be added via the Pianist mode or Sound mode menus. When created, each Favorite memory will store the settings listed below.

Tap the [Favorite] button to show the Favorite screen.

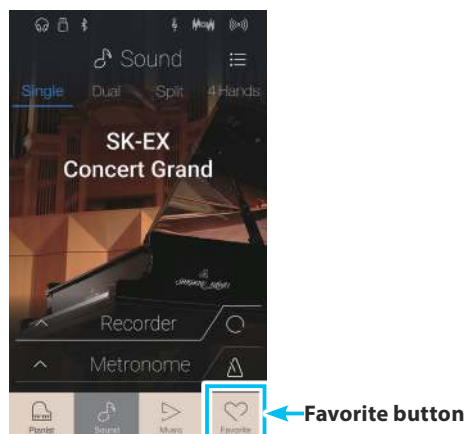

Functions and Settings stored to Favorite memories

Pianist Mode
Rendering character
Resonance depth
Ambience (type/depth)
Sound Mode
Single: Sound
Dual: Sounds, Balance, Layer Octave Shift, Layer Dynamics
Split: Sounds, Balance, Lower Octave Shift, Lower Pedal, Split Point
4Hands: Sounds, Left Octave Shift, Right Octave Shift, Split Point
Reverb (type/depth)
Effects (type/settings)
Transpose
Sound Settings
Tuning
Tone Control
Damper Hold

Metronome Settings
Mode
Tempo
Time Signature/Rhythm
Volume
Virtual Technician Settings
Touch Curve (incl. User)
Voicing (incl. User)
Damper Resonance
Damper Noise
String Resonance
Undamped String Resonance
Cabinet Resonance
Key-off Effect
Fall-back Noise
Hammer Delay
Topboard Simulation
Decay Time
Minimum Touch
Stretch Tuning (incl. User)
Temperament (incl. User)
Temperament Key
Key Volume (incl. User)
Half-Pedal Adjust
Soft Pedal Depth

Favorite screen

① Menu button

Tap to open the Favorite settings menu.

② Page indicator

Indicates the current Favorite page, and how many Favorite pages (1~4) are available.

③ Favorite memory buttons

Tap to select the desired Favorite memory.

Swipe this area left/right to cycle through the available Favorite pages.

* This area will be empty by default, but will become populated as new Favorite memories are stored.

* Favorite memories stored in Pianist mode will be represented by a piano icon, while Favorite memories stored in Sound mode will be represented by a musical note icon.

④ Recorder bar / Record Start/Stop button

Tap to open the Recorder settings and/or Start/Stop the recorder.

* For more information about the Recorder function, please refer to page 39

⑤ Metronome bar / Metronome Start/Stop button

Tap to open the Metronome settings and/or Start/Stop the metronome.

* For more information about the Metronome function, please refer to page 36.

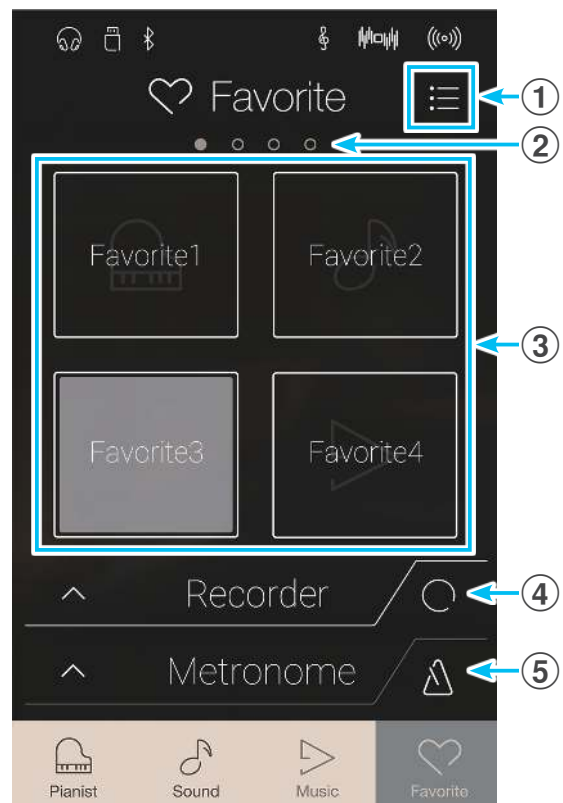

Favorite settings menu

① Startup with Favorite On/Off

Tap to specify whether or not the instrument should startup with the Favorite screen.

② Edit Favorite

Tap to show the Edit Favorite screen, used to delete or reposition Favorite memories.

③ Rename Selected Favorite

Tap to rename the selected Favorite memory.

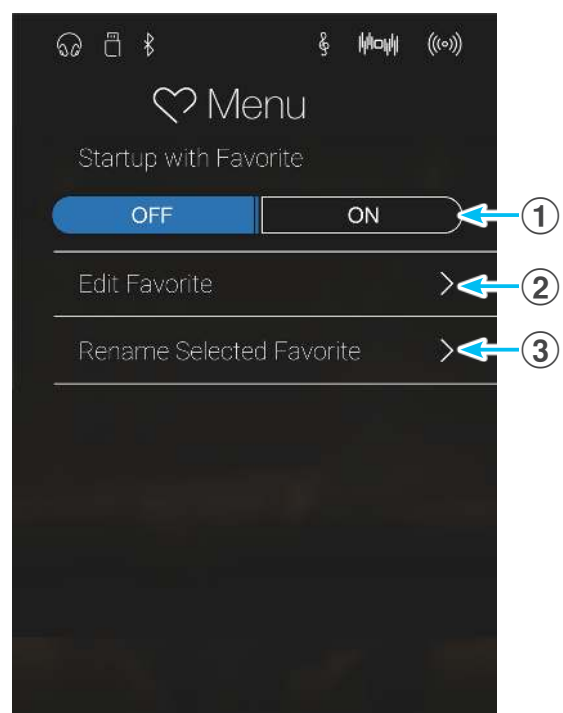

1 Storing and Selecting Favorite memories

■ Storing a Favorite memory

The following procedure will store the current instrument settings to a Favorite memory.

1. In either Pianist or Sound mode, tap the [Menu] button to show the mode's menu.

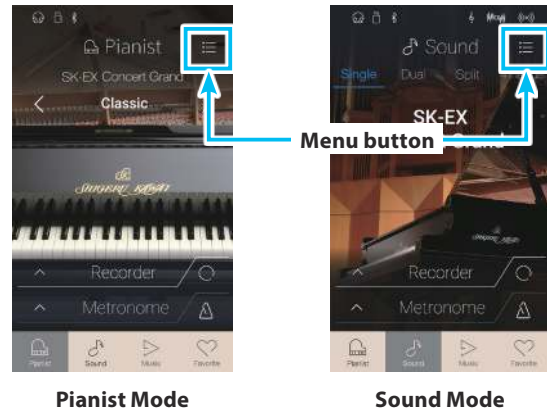

2. Tap [Store to Favorite] at the bottom of the menu.

* In Sound mode, it may be necessary to scroll the screen in order to see the 'Store to Favorite' function.

The Favorite Name screen will be shown.

3. Enter the desired name for the Favorite memory using the onscreen keyboard, then tap the enter key to confirm the store.

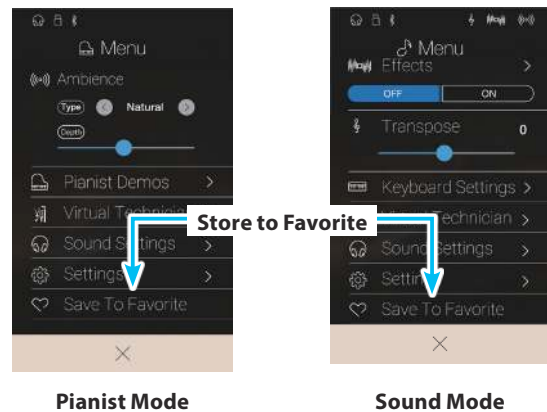

■ Selecting a Favorite memory

The following procedure will select a previously stored Favorite memory.

1. Tap the [Favorite] button.

The Favorite screen will be shown.

* If a Favorite memory was selected previously, that memory will be re-selected automatically.

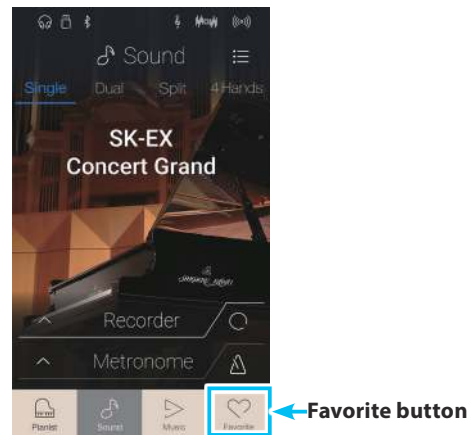

2. Tap the desired Favorite memory.

The Favorite memory will be selected, and its settings will be recalled.

If necessary, swipe the screen left/right to cycle through the available Favorite pages.

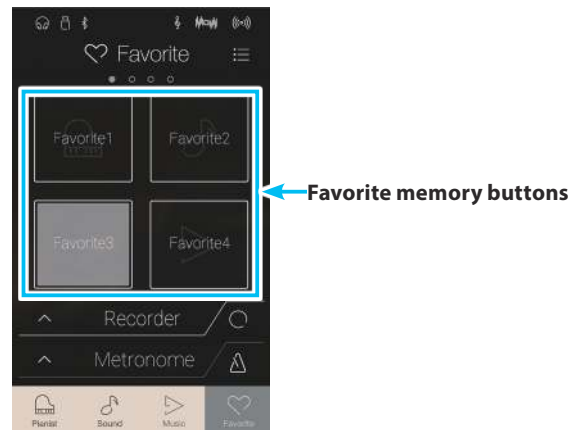

2 Editing Favorite memories

■ Renaming a Favorite memory

The following procedure will rename the currently selected Favorite memory.

1. Tap the [Menu] button.

The Favorite settings menu will be shown.

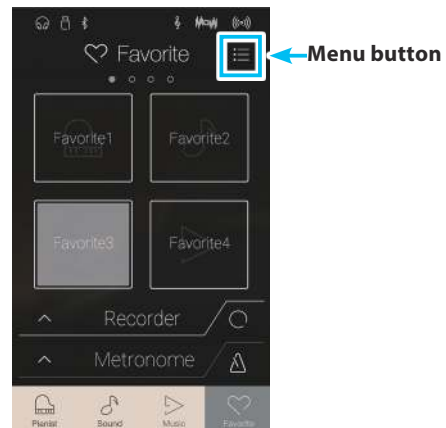

2. Tap [Rename Selected Favorite].

The Favorite Name screen will be shown.

3. Enter the desired name for the Favorite memory using the onscreen keyboard, then tap the enter key to confirm the store.

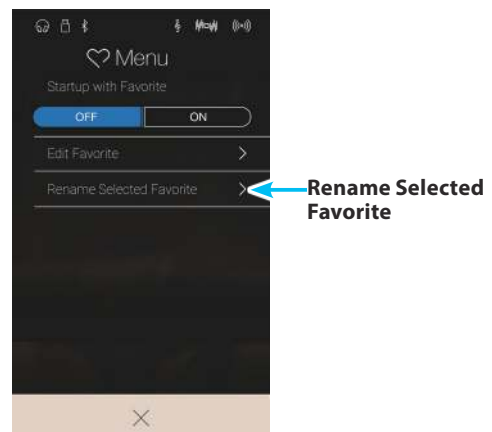

■ Deleting a Favorite memory

The following procedure allows Favorite memories to be deleted.

1. Tap the [Menu] button.

The Favorite settings menu will be shown.

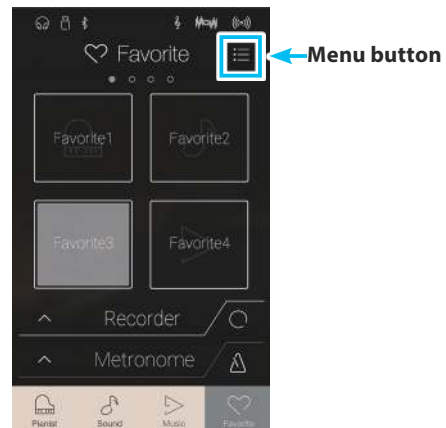

2. Tap [Edit Favorite].

The Edit Favorite screen will be shown.

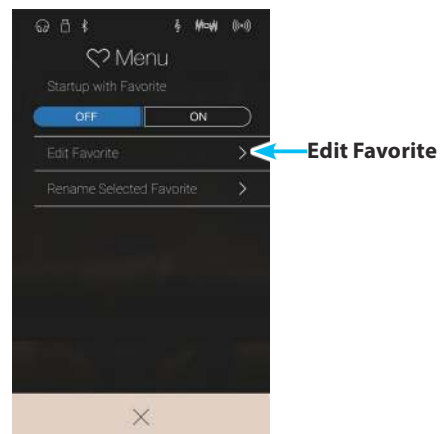

3. Tap the [X] icon in the top-left corner of a Favorite memory to delete that memory.

If necessary, swipe the screen left/right to cycle through the available Favorite pages.

4. Tap the [Back] button to exit the Edit Favorite screen and return to the Favorite settings menu.

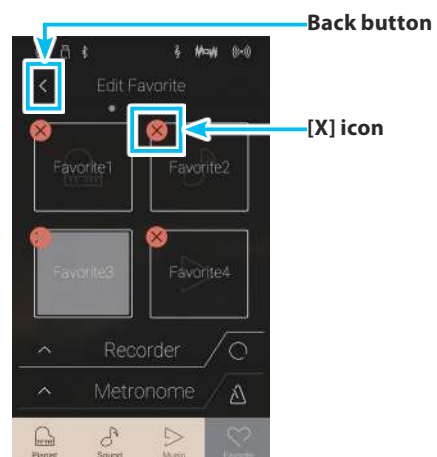

About the Favorite Screen

■ Repositioning a Favorite memory

The following procedure allows a Favorite memory to be repositioned.

1. Tap the [Menu] button.

The Favorite settings menu will be shown.

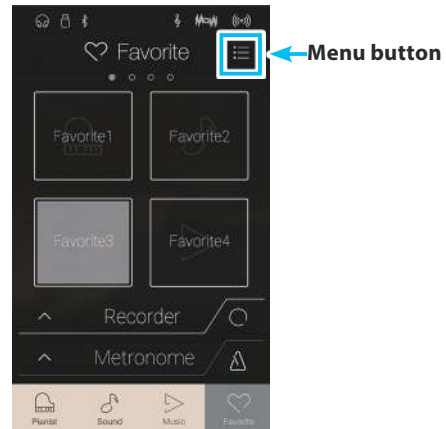

2. Tap [Edit Favorite].

The Edit Favorite screen will be shown.

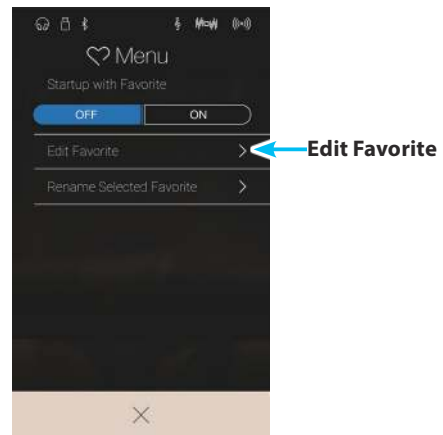

3. Long press a favorite memory, then drag the memory into the desired position.

Release the finger to confirm the new Favorite memory position.

* It is also possible move a memory onto another page, by dragging the memory to the left of right edge of the screen.

4. Tap the [Back] button to exit the Edit Favorite screen and return to the Favorite settings menu.

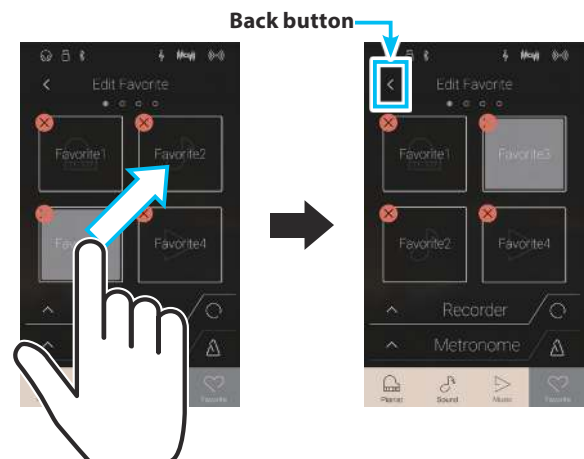

■ Startup with Favorite function

When the Startup with Favorite function is enabled, the NV10 hybrid digital piano will show the Favorite screen when the instrument is turned on, and will select the first Favorite memory automatically.

1. Tap the [Menu] button.

The Favorite settings menu will be shown.

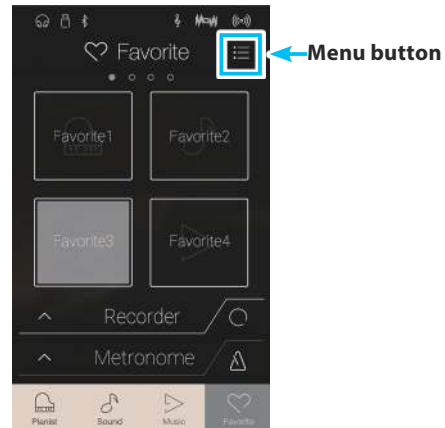

2. Tap the Startup with Favorite [ON/OFF] button to enable the function.

The next time the instrument is turned on, the Favorite screen will be shown, with the first (top-left) Favorite memory selected automatically.

- * To startup with a different Favorite memory, follow the steps above to reposition that memory to the first position.
- * To startup in Pianist mode, set the 'Startup with Favorite' function to Off.

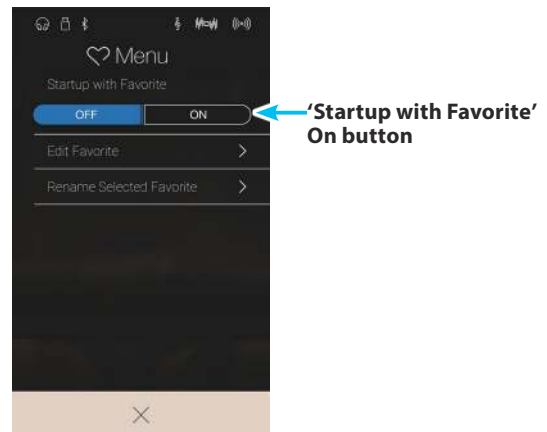

About Settings

The Pianist mode menu and Sound mode menu contain a variety of options to adjust the NV10 hybrid digital piano's operation and sound. These settings are grouped by category, providing convenient access to relevant controls. The available settings will differ depending on whether Pianist mode or Sound mode is being used. Once adjusted, settings can be stored to one of the instrument's 16 Favorite memories for instant recall.

1 Pianist mode menu

The Pianist mode menu contains the following settings and functions.

■ Pianist mode settings and functions

Setting menu	Description	Available Settings	Page no.
Ambience	Adjust the sense of sound moving around in a virtual room.	Type	p. 89
		Depth	p. 89
Virtual Technician	Adjust various characteristics of the simulated grand piano sound.	Touch Curve	p. 102
		Voicing	p. 104
		Damper Noise	p. 106
		Fall-back Noise	p. 111
		Hammer Delay	p. 112
		Minimum Touch	p. 114
		Key Volume	p. 120
		Half-Pedal Adjust	p. 122
		Soft Pedal Depth	p. 122
		Save to Sound	p. 101
Sound Settings	Adjust settings related to the overall sound, such as the volume of speakers, headphones, line inputs, etc.	Tone Control	p. 125
		Speaker Volume	p. 127
		Line In Level	p. 128
		Wall EQ	p. 129
		SHS Mode	p. 130
		Phones Type	p. 131
		Phones Volume	p. 132
System Settings	Adjust settings related to the instrument's operation, such as Bluetooth and MIDI connectivity, USB functions, LCD appearance, etc.	Bluetooth MIDI	p. 134
		Bluetooth Audio	p. 135
		Bluetooth Audio Volume	p. 136
		Rename File*	p. 137
		Delete File*	p. 138
		USB Format*	p. 139
		MIDI Channel	p. 142
		Send PGM#	p. 143
		Local Control	p. 143
		Transmit PGM# On/Off	p. 144
		Multi-timbral Mode	p. 145
		Channel Mute	p. 145
		LCD Contrast	p. 146
		Auto Display Off	p. 146
		Auto Power Off	p. 147
		Factory Reset	p. 148

* USB functions will only be visible when a USB memory device is connected to the NV10 hybrid digital piano.

■ Pianist mode menu

- ① **Ambience type** (p. 89)
Swipe left/right or tap the arrow buttons to change the ambience type used for the SK-EX Rendering piano sound engine.
Ambience refers to the sense of sound moving around in a virtual room.
- ② **Ambience depth** (p. 89)
Long press and drag the slider to adjust the depth/strength of the ambience.
- ③ **Pianist Demos** (p. 90)
Tap to open the Pianist Demos screen, which performs pieces that demonstrate the SK-EX Rendering piano sound engine.
- ④ **Virtual Technician** (p. 98)
Tap to open the Virtual Technician menu.
This menu is used to adjust various characteristics of the acoustic piano sound.
- ⑤ **Sound Settings** (p. 123)
Tap to open the Sound Settings menu.
This menu is used to adjust various settings related to the overall sound of the instrument.
- ⑥ **System Settings** (p. 133)
Tap to open the System Settings menu.
This menu is used to adjust various system settings.
- ⑦ **Store to Favorite** (p. 97)
Tap to store the current piano sound and associated settings to a Favorite memory.
- ⑧ **Close Menu**
Tap to close the menu and return to the Pianist mode screen.

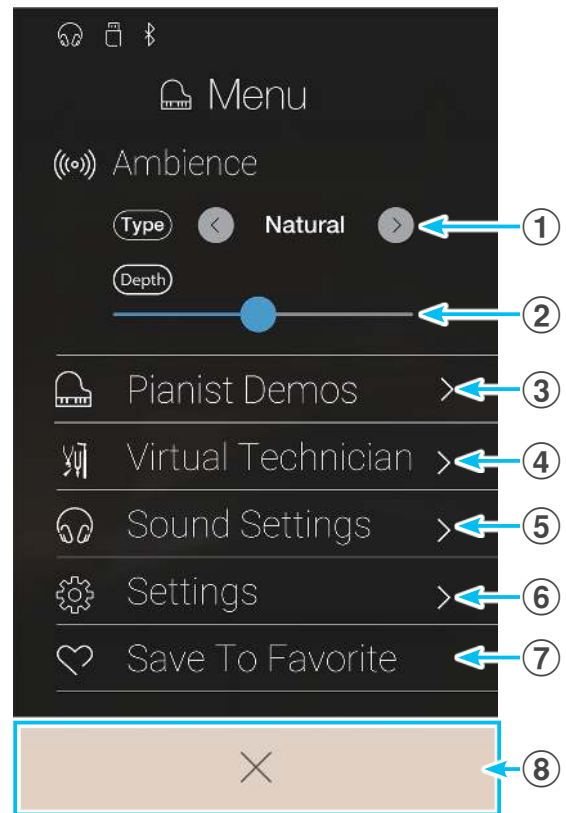

■ Adjusting the Ambience Type and Depth

Ambience refers to the sense of sound moving around in a virtual room.

1. Swipe left/right or tap the arrow buttons to change the ambience type used for the SK-EX Rendering piano sound engine.

* The Ambience type can be set to one of 10 types, listed below.

2. Long press and drag the slider to adjust the depth/strength of the ambience.

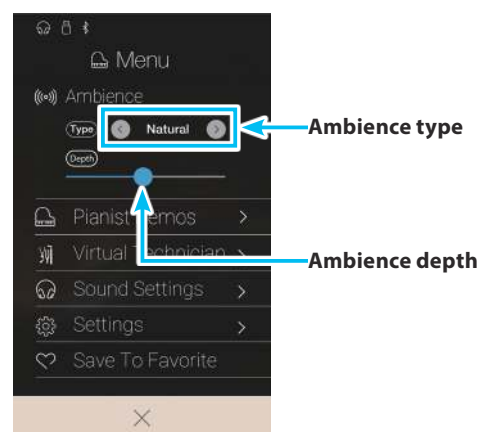

About Settings

■ Ambience types

Ambience Type	Description
Natural	Simulates the ambience of a natural environment.
Small Room	Simulates the ambience/reverberation of a small room.
Medium Room	Simulates the ambience/reverberation of a medium-sized room.
Large Room	Simulates the ambience/reverberation of a large room.
Studio	Simulates the ambience/reverberation of a recording studio.
Wood Studio	Simulates the ambience/reverberation of a wooden recording studio.
Mellow Lounge	Simulates the soft ambience/reverberation of a lounge.
Bright Lounge	Simulates the bright ambience/reverberation of a lounge.
Live Stage	Simulates the ambience/reverberation of a live stage.
Echo	Simulates the ambience/reverberation of an echo chamber.

■ About Pianist Demos screen

This screen contains pieces that demonstrate the SK-EX Rendering piano sound engine.

- 1 Back button**
Tap to return to the Pianist mode menu.
- 2 Piece title**
Displays the title of the current demo piece.
- 3 Previous button**
Tap to select the previous demo piece for playback.
- 4 Play/Stop button**
Tap to Play/Stop the selected demo piece.
- 5 Next button**
Tap to select the next demo piece for playback.

* When the selected demo piece has finished, the next piece will begin to play automatically.

* While a demo piece is playing, tapping the Back button will cause playback to stop.

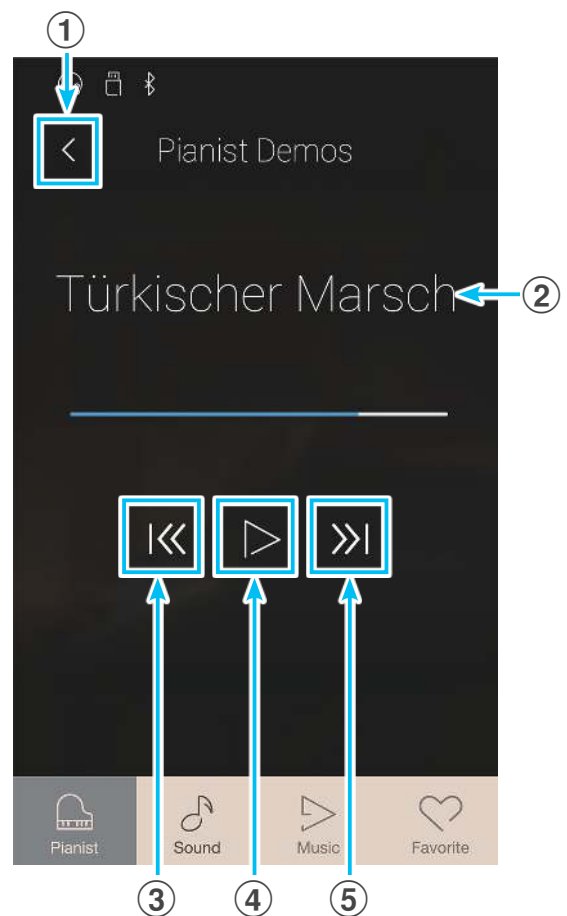

■ About Pianist Demos pieces

	Piece name	Composer
1	Polonaise in A-flat major, Op. 53	Frédéric Chopin
2	Suite bergamasque - Prélude	Claude Debussy
3	Turkish March	Wolfgang Amadeus Mozart

■ Other Pianist mode menu settings

For information regarding the other Pianist mode menu settings, please refer to the pages below:

Virtual Technician: page 98

Sound Settings: page 123

System Settings: page 133

2 Sound mode menu

The Sound mode menu contains the following settings and functions.

■ Sound mode settings and functions

Setting menu	Description	Available Settings	Page no.
Reverb	Adjust the acoustic environment of a virtual room.	Type	p. 95
		Depth	p. 95
Effects	Adjust the tonal character of a sound by applying various effects.	Type	p. 96
		Settings	p. 96
Transpose	Adjust the pitch of the keyboard in semi-tone steps.	Key	p. 97
Keyboard Settings (not shown when Single keyboard mode is selected)	Adjust various settings related to the Dual, Split, and 4Hands keyboard modes.	Dual Balance, Layer Octave Shift, Layer Dynamics	p. 97
		Split Balance, Lower Octave Shift, Lower Pedal, Split Point	p. 97
		4Hands Balance, Right Octave Shift, Left Octave Shift, Split Point	p. 97
Virtual Technician	Adjust various characteristics of the simulated grand piano sound.	Virtual Technician Mode	p. 98
		Touch Curve	p. 102
		Voicing	p. 104
		Damper Resonance	p. 106
		Damper Noise	p. 106
		String Resonance	p. 107
		Undamped String Resonance	p. 108
		Cabinet Resonance	p. 109
		Key-off Effect	p. 110
		Fall-back Noise	p. 111
		Hammer Delay	p. 112
		Topboard Simulation	p. 113
		Decay Time	p. 114
		Minimum Touch	p. 114
		Stretch Tuning	p. 115
		Temperament	p. 117
		Temperament Key	p. 119
		Key Volume	p. 120
		Half-Pedal Adjust	p. 122
		Soft Pedal Depth	p. 122
Save to Sound	p. 101		
Smart Mode Type	p. 98		

Setting menu	Description	Available Settings	Page no.
Sound Settings	Adjust settings related to the overall sound, such as the volume of speakers, headphones, line inputs, etc.	Tuning	p. 124
		Damper Hold	p. 124
		Tone Control	p. 125
		Speaker Volume	p. 127
		Line In Level	p. 128
		Wall EQ	p. 129
		SHS Mode	p. 130
		Phones Type	p. 131
		Phones Volume	p. 132
System Settings	Adjust settings related to the instrument's operation, such as Bluetooth and MIDI connectivity, USB functions, LCD appearance, etc.	Bluetooth MIDI	p. 134
		Bluetooth Audio	p. 135
		Bluetooth Audio Volume	p. 136
		Rename File*	p. 137
		Delete File*	p. 138
		USB Format*	p. 139
		MIDI Channel	p. 142
		Send PGM#	p. 143
		Local Control	p. 143
		Transmit PGM# On/Off	p. 144
		Multi-timbral Mode	p. 145
		Channel Mute	p. 145
		LCD Contrast	p. 146
		Auto Display Off	p. 146
		Auto Power Off	p. 147
Factory Reset	p. 148		

* USB functions will only be visible when a USB memory device is connected to the NV10 hybrid digital piano.

■ Sound mode menu

- ① **Reverb settings** (p. 95)
Tap to open the Reverb settings menu.
This menu is used to adjust the Reverb type and depth.
- ② **Reverb ON/OFF** (p. 95)
Tap to turn Reverb On/Off.
- ③ **Effects settings** (p. 96)
Tap to open the Effects settings menu.
This menu is used to adjust the Effects type and settings.
- ④ **Effects ON/OFF** (p. 96)
Tap to turn Effects On/Off.
- ⑤ **Transpose** (p. 97)
Long press and drag the slider to adjust the pitch of the keyboard in semi-tone steps.
- ⑥ **Keyboard Settings** (p. 97)
Tap to open the Keyboard Settings menu.
This menu is used to adjust Dual, Split, and 4Hands keyboard mode settings.

* This item will not be shown when Single keyboard mode is selected.
- ⑦ **Virtual Technician** (p. 98)
Tap to open the Virtual Technician menu.
This menu is used to adjust various characteristics of the acoustic piano sound.
- ⑧ **Sound Settings** (p. 123)
Tap to open the Sound Settings menu.
This menu is used to adjust various settings of the sound.
- ⑨ **System Settings** (p. 133)
Tap to open the System Settings menu.
This menu is used to adjust various system settings.
- ⑩ **Store to Favorite** (p. 97)
Tap to store the current sound and associated settings to a Favorite memory.
- ⑪ **Close Menu**
Tap to close the menu and return to the Pianist mode screen.

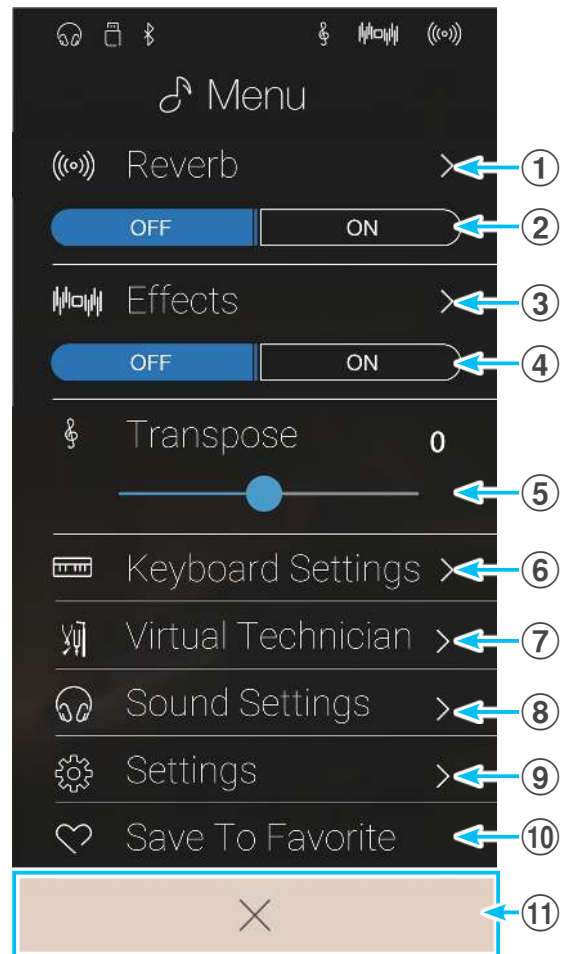

■ Adjusting the Reverb settings

Reverb refers to the acoustic environment of a virtual room.

1. Tap the [ON/OFF] buttons to turn Reverb on/off.

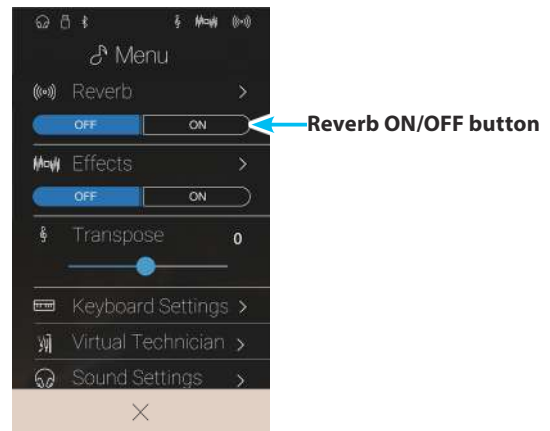

2. Tap [Reverb] to open the Reverb settings menu.

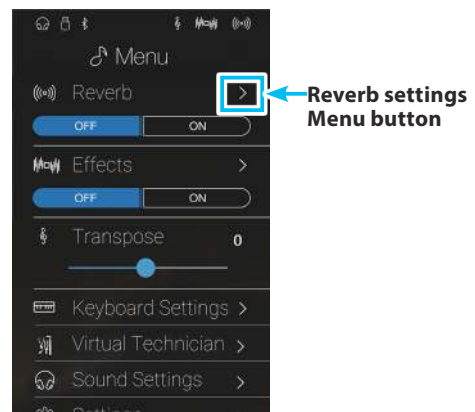

3. Swipe left/right or tap the arrow buttons to change the reverb type.

* The Reverb type can be set to one of 6 types, listed below.

4. Long press and drag the two sliders to adjust the depth and time of the reverb.

* The Reverb depth and time can be adjusted within the range of 1~10

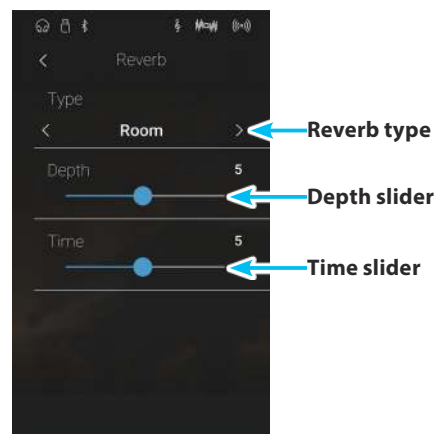

■ Reverb types

Reverb type	Description
Room	Simulates the ambience of a small rehearsal room.
Lounge	Simulates the ambience of piano lounge.
Small Hall	Simulates the ambience of a small hall.
Concert Hall	Simulates the ambience of a concert hall or theatre.
Live Hall	Simulates the ambience of a live hall or stage.
Cathedral	Simulates the ambience of a large cathedral.

About Settings

■ Adjusting the Effect settings

Effects alter the tonal character and feeling of an instrument sound.

1. Tap the [ON/OFF] buttons to turn Effects on/off.

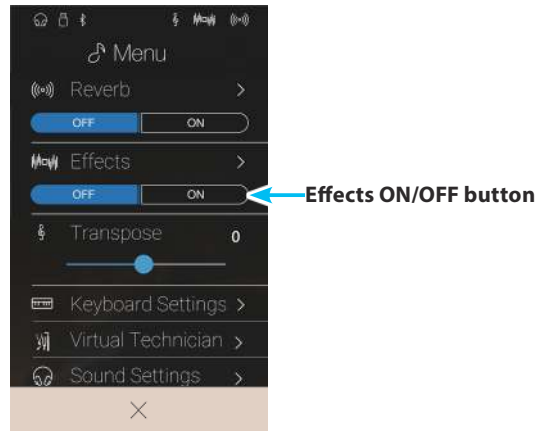

2. Tap [Effects] to open the Effects settings menu.

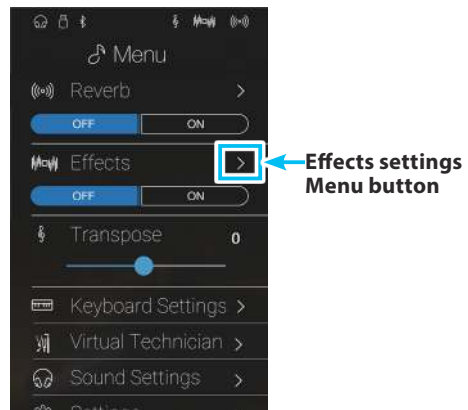

3. Swipe left/right or tap the arrow buttons to change the Effect type.

* The Effect type can be set to one of 24 types. For a full list of available effect types, please refer to page 35.

4. Long press and drag the two sliders to adjust the settings of the effect.

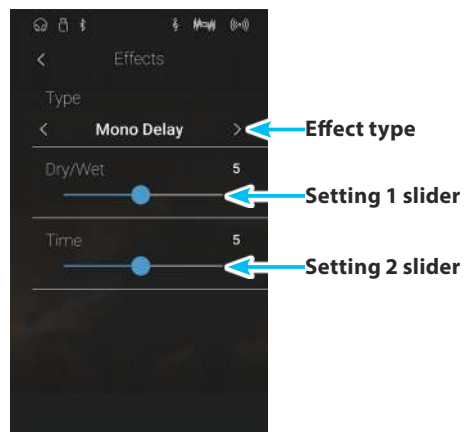

■ Adjusting the Transpose setting

The Transpose setting allows the pitch of the NV10 hybrid digital piano keyboard to be raised or lowered in semi-tone steps. This is particularly useful when accompanying instruments tuned for different keys, or when a song learned in one key must be played in another key. When transposed, the song can be played in the original key, yet heard in a different key.

Long press and drag the slider to adjust the value of the Transpose settings.

* The Transpose value can be adjusted within the range of -12~+12.

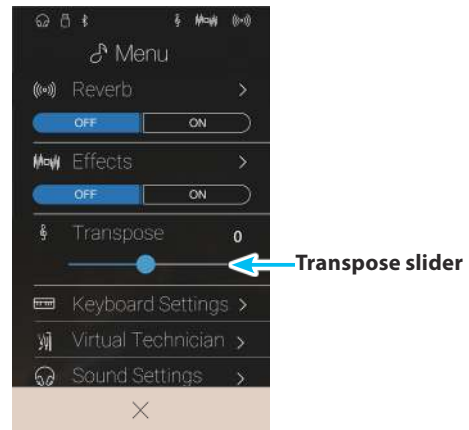

■ Adjusting the Keyboard Settings

The Keyboard Settings menu is used to adjust Dual, Split, and 4Hands keyboard mode settings.

* This item will not be shown when Single keyboard mode is selected.

The settings in this menu will vary depending on the keyboard mode selected. For more information regarding the different keyboard modes, and adjusting their relevant settings, please refer to the pages below:

Dual keyboard mode: page 27

Split keyboard mode: page 29

4Hands keyboard mode: page 31

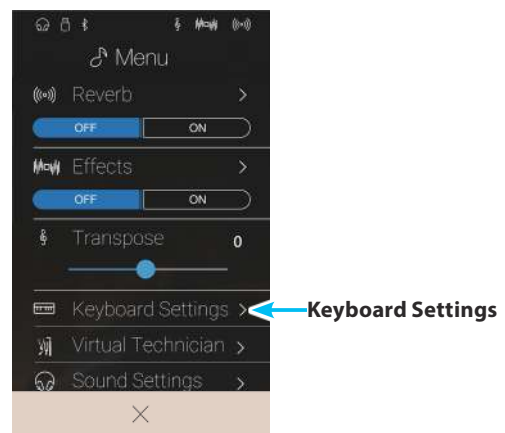

■ Store to Favorite function

The Store to Favorite function is used to store the current instrument settings to a Favorite memory.

1. Tap [Store to Favorite].

The Favorite Name screen will be shown.

2. Enter the desired name for the Favorite memory using the onscreen keyboard, then tap the enter key to confirm the store.

* For more information about the Favorites function, please refer to page 80.

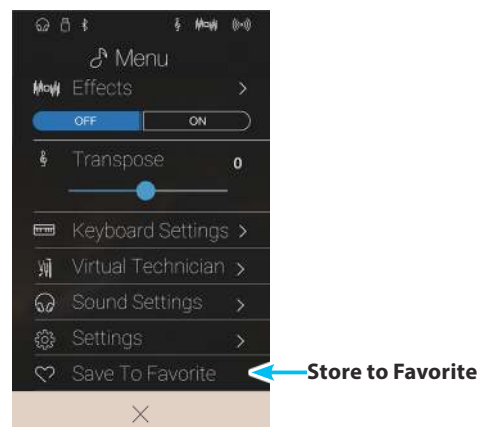

Virtual Technician

The Virtual Technician menu contains a variety of settings that allow the character of the NV10's acoustic piano to be dramatically adjusted. There are two methods of using the Virtual Technician: Smart Mode and Advanced Mode.

Tap [Virtual Technician] to open the Virtual Technician menu.

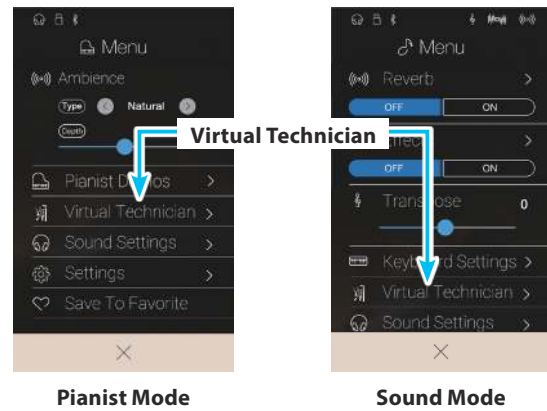

Smart Mode

In Smart Mode, the Virtual Technician intelligently performs a collection of adjustments for the player, based on ten preset attributes such as 'Soft' or 'Strong', 'Brilliant' or 'Gloomy'. This mode is recommended for musicians that wish to enjoy different piano characteristics, without delving into the individual parameters of Advanced Mode.

* The Smart Mode Virtual Technician is only available in Sound mode.

Tap the [Smart] button to select the Smart Mode Virtual Technician.

1 Back button

Tap to return to the Sound mode menu.

2 Virtual Technician mode select

Tap to change the Virtual Technician to Smart or Advanced mode.

3 Smart Mode preset

Swipe left/right or tap the arrow buttons to change the Smart Mode preset.

4 Smart Mode preset explanation

Displays information about the currently selected Smart Mode preset.

5 Save to Sound

Tap to save the current Virtual Technician settings to the selected instrument sound.

* It is also possible to use the Favorites function to store preferred Virtual Technicians settings to memory. For more information please refer to pages 82 and 99.

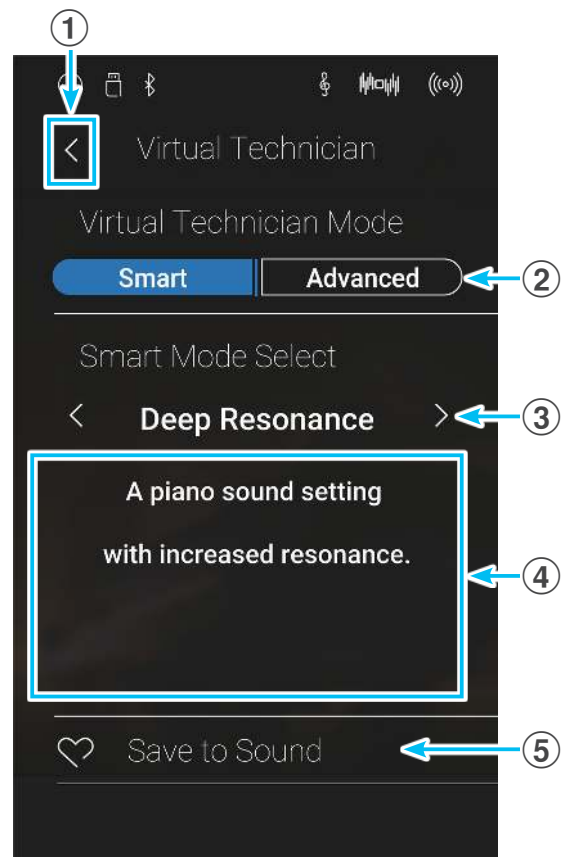

■ Changing the Smart Mode preset

Adjust the overall character of the sound using a preset.

1. Swipe left/right or tap the arrow buttons to change the Smart Mode preset

The tonal character of the piano sound will change, and information about the selected Smart Mode preset will be shown in the explanation area.

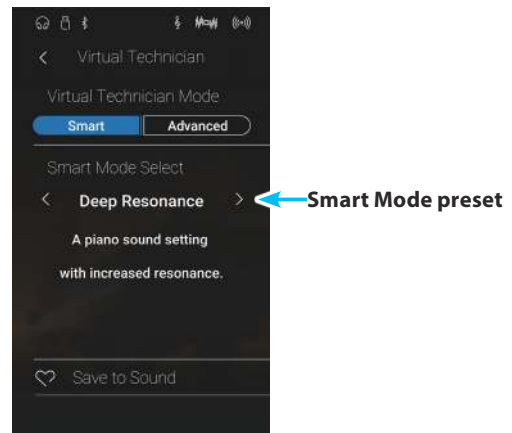

■ Storing the Smart Mode preset

Store the current Virtual Technician settings to the selected instrument sound.

1. Tap [Store to Sound].

The current Virtual Technician Smart Mode preset will be stored to the selected instrument sound, and recalled automatically whenever that sound is selected.

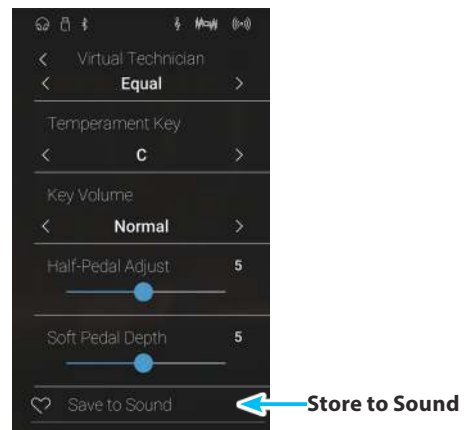

■ Advanced Mode

In Advanced Mode, the player is given full control over every aspect of the piano's configuration, allowing precise adjustments over hammer hardness, action regulation, cabinet size, and a variety of other acoustic characteristics. This mode is recommended for musicians that enjoy fine-tuning individual details of the piano sound in order to suit their personal preferences.

In Sound mode, Virtual Technician settings are adjusted and stored independently for each sound, variation, allowing flexible control over the characteristics of each piano voice.

* The Advanced Mode Virtual Technician is available in both Pianist and Sounds modes, however some settings will be hidden in Pianist mode.

* The Advanced Mode Virtual Technician settings in Pianist mode and Sound mode are adjusted independently.

■ Virtual Technician Advanced mode settings

No.	Setting	Description	Pianist Mode	Default	Page no.
1	Touch Curve	Adjust the touch sensitivity of the keyboard.	✓	Normal	p. 102
2	Voicing	Adjust the tonal character of the instrument.	✓	Normal	p. 104
	User Voicing	Adjust the individual voicing of each of the 88 keys.	✓	–	p. 105
3	Damper Resonance	Adjust the resonance that is heard when pressing the damper pedal.		5	p. 106
4	Damper Noise	Adjust the sound that is heard when pressing the damper pedal.	✓	5	p. 106
5	String Resonance	Adjust the resonance that is heard when notes are held.		5	p. 107
6	Undamped Str. Res.	Adjust the resonance produced by the topmost undamped strings.		5	p. 108
7	Cabinet Resonance	Adjust the resonance produced by the piano cabinet itself.		1	p. 109
8	Key-off Effect	Adjust the sound that is heard when keys are released.		5	p. 110
9	Fall-back Noise	Adjust the sound that is heard when the key action falls back.	✓	5	p. 111
10	Hammer Delay	Adjust the delay of the hammer striking strings when playing pianissimo.	✓	Off	p. 112
11	Topboard Simulation	Adjust the position of the grand piano topboard.		Open 3	p. 113
12	Decay Time	Adjust the decay time of the piano sound while the keys are pressed.		5	p. 114
13	Minimum Touch	Adjust the minimum key velocity required to produce a sound.	✓	1	p. 114
14	Stretch Tuning	Adjust the level of stretch tuning for equal temperaments.		Normal	p. 115
	User Tuning	Adjust the individual tuning of each of the 88 keys.		–	p. 116
15	Temperament	Adjust the tuning system to suit Renaissance and Baroque periods etc.		Equal Temp.	p. 117
	User Temperament	Adjust the tuning of each note in the scale to a custom temperament.		–	p. 118
16	Temperament Key	Adjust the key of the selected tuning system.		C	p. 119
17	Key Volume	Adjust the volume balance of the keyboard.	✓	Normal	p. 120
	User Key Volume	Adjust the individual volume of each of the 88 keys.	✓	–	p. 121
18	Half-Pedal Adjust	Adjust the point at which the damper pedal begins to sustain the sounds.	✓	5	p. 122
19	Soft Pedal Depth	Adjust the depth/effectiveness of the soft pedal.	✓	3	p. 122

■ Storing the Virtual Technician settings

Store the current Virtual Technician settings to the selected instrument sound.

1. Tap [Store to Sound].

The current Virtual Technician settings will be saved to the selected instrument sound, and recalled automatically whenever that sound is selected.

* In Pianist mode, the Store to Sound function can be used to automatically recall preferred settings whenever the instrument is turned on, without needing to use Favorite memories.

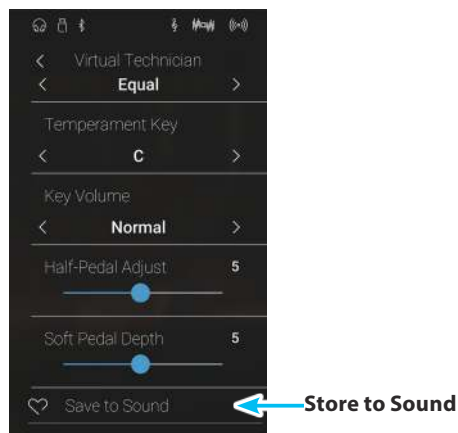

■ About Stored Virtual Technician settings

As mentioned above, in Sound mode, the Virtual Technician settings are adjusted and stored independently for each sound. This allows different Virtual Technician adjustments to be made for each piano voice. For example, it may be desirable to voice the SK Concert Grand piano a little brighter than the EX Concert Grand piano, or increase the Damper, String, and Cabinet Resonances of the SK-5 Grand while leaving the Pop Piano unchanged.

1 Touch Curve

Pianist Mode

Sound Mode

As with an acoustic piano, the NV10 hybrid digital piano produces a louder sound when the keys are struck with force, and a softer sound when the keys are played gently. The volume and tonal character change in relation to the strength and velocity of playing – on a digital piano this system is referred to as ‘touch sensitivity’.

The Touch Curve setting allows the touch sensitivity of the keyboard to be conveniently adjusted. There are six different preset touch curve settings available, with an additional ‘User’ setting allowing performers to customise the instrument’s keyboard responsiveness to suit their individual playing style.

The default ‘Normal’ setting is designed to accurately recreate the touch of a Kawai concert grand piano. However, if the keyboard feels too light, or fortissimo playing is achieved too easily, it may be desirable to select a heavier touch curve. Alternatively, if the keyboard feels too heavy, or fortissimo playing is too difficult to achieve, it may be desirable to select a lighter touch curve.

* This Virtual Technician setting will affect all sounds.

■ Touch Curve types

Touch Curve	Description
Light +	Requires less striking force to achieve a forte note. For players with a very delicate touch.
Light	A louder volume is produced even when playing with a soft touch. For those still developing finger strength. * This touch curve is recommended for children and organ players.
Normal (default)	Reproduces the standard touch sensitivity of an acoustic piano.
Heavy	Requires a heavier touch to produce a loud volume. Ideally suited to those with stronger fingers.
Heavy +	Requires considerably more striking force to achieve a loud volume.
Off (constant)	A constant volume is produced regardless of how hard the keys are struck. * This touch curve intended for playing sounds of instruments that have a fixed dynamic range (e.g. organ and harpsichord).
User	A custom touch curve, created to suit an individual’s personal playing style.

■ Touch Curve graph

The illustration below provides a visual representation of the different Touch Curve settings.

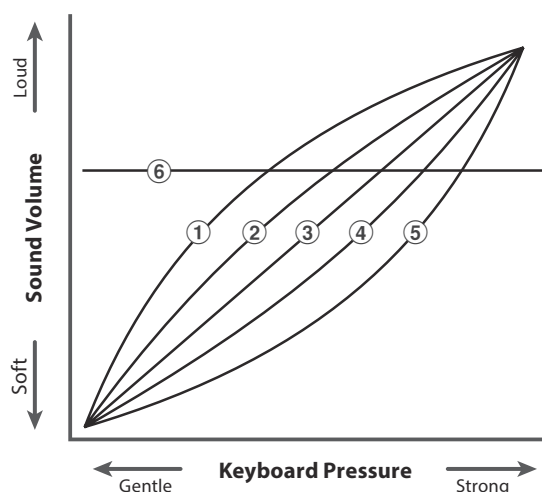

No.	Touch Curve
①	Light +
②	Light
③	Normal (default)
④	Heavy
⑤	Heavy +
⑥	Off (constant)

■ Changing the Touch Curve type

Swipe left/right or tap the arrow buttons to change the Touch Curve type.

* The Touch Curve can be set to one of 7 types.

The perceived weight of the keyboard will change depending on the selected touch curve.

* Any changes made to the Touch Curve setting will remain until the power is turned off.

* Preferred Touch Curve settings can be stored to the sound's memory (in Sound mode) or a Favorite memory for convenient recall. Please refer to pages 82 and 101 for more information.

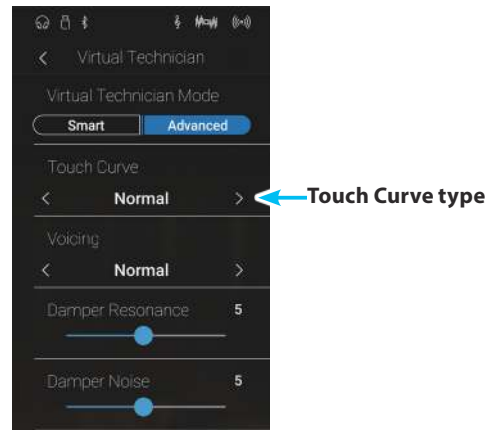

User Touch Curve

Pianist Mode

Sound Mode

The User Touch Curve function automatically creates a custom touch curve, based on the individual's playing style.

■ Creating a User Touch Curve

1. Swipe left/right or tap the arrow buttons to select the User touch curve type.

2. Tap the [Edit] button.

The User Touch Curve screen will be shown.

3. Tap the [Start] button.

4. Play the piano dynamically from very soft to very loud, allowing the instrument to examine the personal playing technique.

* More than one attempt may be required in order to create an accurate User Touch Curve.

* Reducing the master volume fader to the lowest position before creating the User Touch Curve may help to reduce user distractions, thus improving accuracy.

5. Tap the [Stop] button.

The new User Touch Curve will be stored to the User touch type, and selected automatically.

6. Tap the [Back] button to return to the Virtual Technician menu.

* If desired, tap [Save to Sound] to ensure that the User touch type is retained after the instrument's power is turned off.

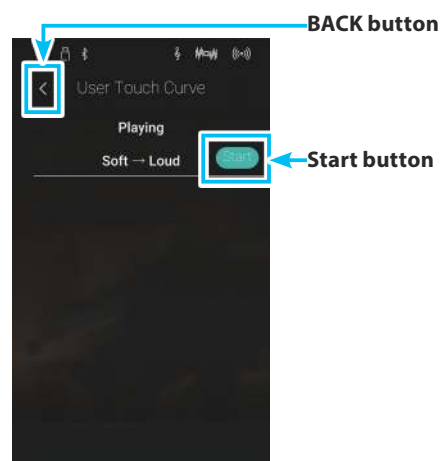
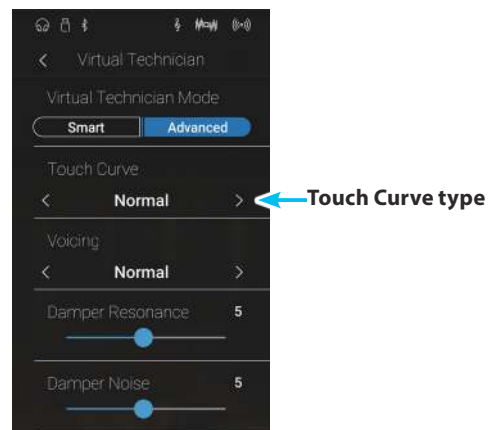

2 Voicing

Pianist Mode

Sound Mode

On an acoustic piano, the shape, density, and texture of the hammers all influence on the tonal character of the instrument's sound. Technicians utilise a variety of tools such as needles, files, and brushes to manipulate these hammer felts, with the ultimate goal of achieving a balanced tonal character across the keyboard.

The Voicing setting recreates various hammer properties, allowing the overall tonal character of the NV10 hybrid digital piano to be adjusted. There are six different preset voicing settings available (applied uniformly to all keys), with an additional 'User' setting allowing players to perform custom adjustments on each individual key.

While the default 'Normal' voicing setting should be appropriate for a broad range of musical genres, it may be desirable to select a softer, more mellow tonal character for romantic pieces, or a brighter, more aggressive tone for modern styles.

* This Virtual Technician setting will affect all sounds.

Voicing types

Voicing type	Description
Normal (default)	The normal tonal character of an acoustic piano throughout the entire dynamic range.
Mellow 1	A softer, more mellow tonal character throughout the entire dynamic range.
Mellow 2	An even softer tonal character than Mellow 1.
Dynamic	A tonal character that changes dramatically from mellow to bright, depending on the strength of key strike.
Bright 1	A bright tonal character throughout the entire dynamic range.
Bright 2	An even brighter tonal character than Bright 1.
User	A custom tonal character, allowing each key to be individually voiced.

Changing the Voicing type

Swipe left/right or tap the arrow buttons to change the Voicing type.

* The Touch Curve can be set to one of 7 types.

The tonal character of the sound will change depending on the selected voicing type.

* Any changes made to the Voicing setting will remain until the power is turned off.

* Preferred Voicing settings can be stored to the sound's memory (in Sound mode) or a Favorite memory for convenient recall. Please refer to pages 82 and 101 for more information.



← Voicing type

User Voicing

The User Voicing function allows each of the 88 keys to be voiced individually.

■ Adjusting the User Voicing function

1. Swipe left/right or tap the arrow buttons to select the User Voicing type.

* In Sound mode, User Voicing is performed and stored independently for each sound.

2. Tap the [Edit] button.

The User Voicing screen will be shown.



3. Tap [Key], then press the desired key on the keyboard to be adjusted.

The selected key should be shown.

4. Long press and drag the slider to adjust the User Voicing value for the selected key.

* The User Voicing value can be adjusted within the range of -5~+5, with lower values creating a mellower sound and higher values creating a brighter sound.

5. Tap the [Back] button to return to the Virtual Technician menu.

* If desired, tap [Save to Sound] to ensure that the User Voicing type is retained after the instrument's power is turned off.

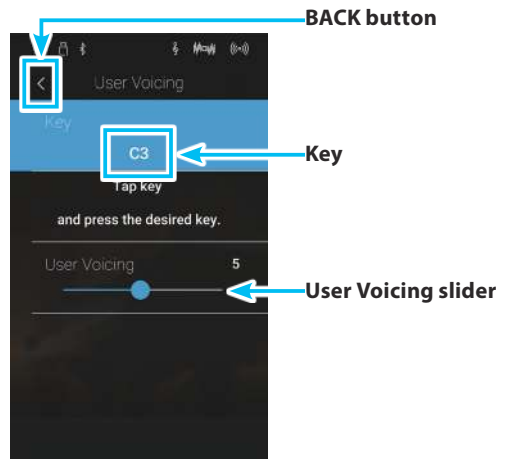

3 Damper Resonance

Sound Mode

Pressing the damper pedal of an acoustic piano raises all dampers, allowing the strings to vibrate freely. When a note or chord is played on the piano with the sustain pedal pressed, not only will the strings of the notes played vibrate, but also the strings of other notes, vibrating in sympathetic resonance.

The NV10 hybrid digital piano recreates this phenomenon, with the Damper Resonance setting allowing the volume of this resonance sound to be adjusted.

* This Virtual Technician setting will affect acoustic piano sounds only.

■ Adjusting the Damper Resonance volume

Long press and drag the slider to increase or decrease the volume of the Damper Resonance setting.

- * The Damper Resonance volume can be adjusted within the range of Off, 1~10, with higher values resulting in a more pronounced resonance.
- * Any changes made to the Damper Resonance setting will remain until the power is turned off.
- * Preferred Damper Resonance settings can be stored to the sound's memory (in Sound mode) or a Favorite memory for convenient recall. Please refer to pages 82 and 101 for more information.



Damper Resonance slider

4 Damper Noise

Pianist Mode

Sound Mode

When the damper pedal of an acoustic piano is pressed and released, it is often possible to hear the sound of the damper head touching and releasing the strings.

The NV10 hybrid digital piano reproduces this sound, with the Damper Noise setting allowing the volume of this sound to be adjusted. The speed at which the damper pedal is pressed will also influence the prominence of the damper noise, with fast pedalling creating a very pronounced sound.

* This Virtual Technician setting will affect acoustic piano sounds only.

■ Adjusting the Damper Noise volume

Long press and drag the slider to increase or decrease the volume of the Damper Noise setting.

- * The Damper Noise volume can be adjusted within the range of Off, 1~10, with higher values resulting in a more pronounced noise.
- * Any changes made to the Damper Noise setting will remain until the power is turned off.
- * Preferred Damper Noise settings can be stored to the sound's memory (in Sound mode) or a Favorite memory for convenient recall. Please refer to pages 82 and 101 for more information.



Damper Noise slider

5 String Resonance

String Resonance refers to a phenomenon that exists in acoustic pianos whereby the strings of held notes resonate 'sympathetically' with other notes of the same harmonic overtone series.

The NV10 hybrid digital piano recreates this phenomenon, with the String Resonance setting allowing the volume of this resonance to be adjusted.

* This Virtual Technician setting will affect acoustic piano sounds only.

Demonstrating String Resonance

To experience the string resonance phenomenon, gently hold down the 'C' key as shown in the illustration below, then play (strike and release quickly) any of the keys marked with a ● symbol. In addition to the sound of each note played, it should also be possible to hear the strings of the first 'C' key resonating 'sympathetically', thus demonstrating String Resonance.

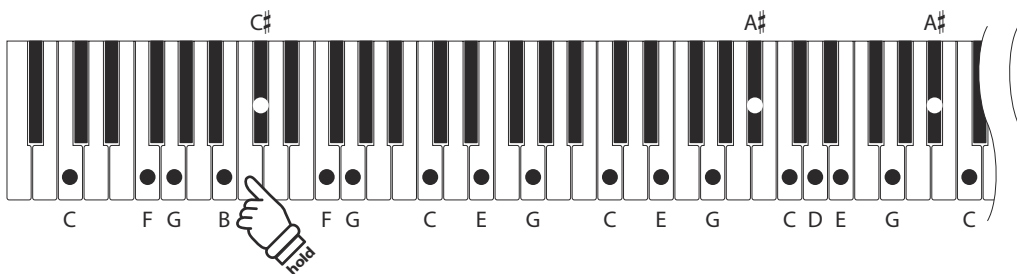

Adjusting the String Resonance volume

Long press and drag the slider to increase or decrease the volume of the String Resonance setting.

- * The String Resonance volume can be adjusted within the range of Off, 1~10, with higher values resulting in a more pronounced resonance.
- * Any changes made to the String Resonance setting will remain until the power is turned off.
- * Preferred String Resonance settings can be stored to the sound's memory (in Sound mode) or a Favorite memory for convenient recall. Please refer to pages 82 and 101 for more information.

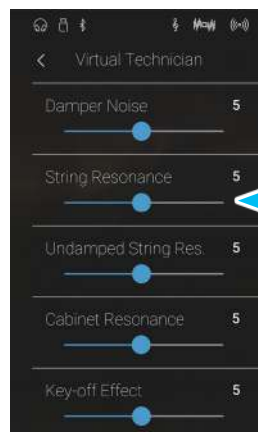

String Resonance slider

6 Undamped String Resonance

The dampers of an acoustic piano span almost the full width of the keyboard. However, the topmost 18 keys (approximately 1.5 octaves) do not incorporate dampers, as the shorter strings for these treble notes decay quickly and therefore do not need to be dampened.

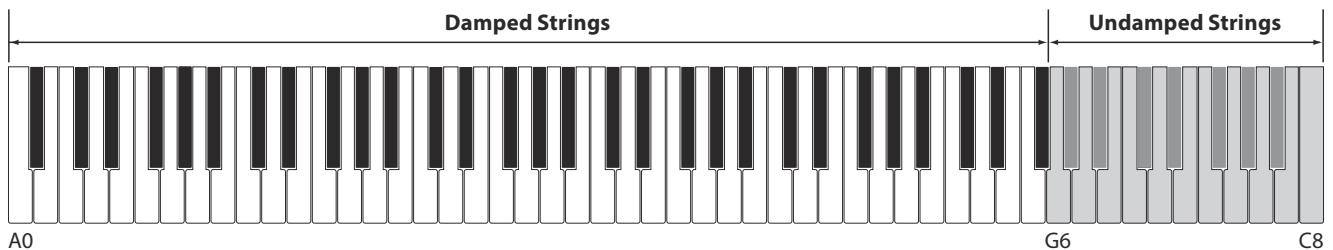

As a result, the strings of these 'undamped' treble notes are free to vibrate in sympathetic resonance with those of lower keys – independently of the damper pedal position – helping to enrich the sound with additional harmonics and tonal colour.

The NV10 hybrid digital piano recreates this phenomenon, with the Undamped String Resonance setting allowing the volume of this resonance sound to be adjusted.

* This Virtual Technician setting will affect acoustic piano sounds only.

■ Adjusting the Undamped String Resonance volume

Long press and drag the slider to increase or decrease the volume of the Undamped String Resonance setting.

- * The Undamped String Resonance volume can be adjusted within the range of Off, 1~10, with higher values resulting in a more pronounced resonance.
- * Any changes made to the Undamped String Resonance setting will remain until the power is turned off.
- * Preferred Undamped String Resonance settings can be stored to the sound's memory (in Sound mode) or a Favorite memory for convenient recall. Please refer to pages 82 and 101 for more information.

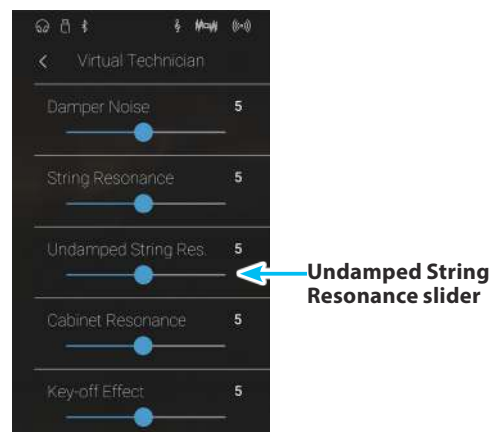

7 Cabinet Resonance

While the fundamental sound of an acoustic piano is produced by vibrating strings, transmitting energy through a spruce soundboard, the cabinet of the instrument itself also contributes a variety of subtle tonal characteristics that enrich the playing and listening experience. The keybed, inner and outer rim, iron plate, and beams all play a role in disseminating sound energy, which in turn gives the piano a living, breathing quality.

The NV10 hybrid digital piano recreates these natural acoustic characteristics, with the Cabinet Resonance setting allowing the volume of this resonance sound to be adjusted.

* This Virtual Technician setting will affect acoustic piano sounds only.

■ Adjusting the Cabinet Resonance volume

Long press and drag the slider to increase or decrease the volume of the Cabinet Resonance setting.

- * The Cabinet Resonance volume can be adjusted within the range of 1~10, with higher values resulting in a more pronounced resonance.
- * Any changes made to the Cabinet Resonance setting will remain until the power is turned off.
- * Preferred Cabinet Resonance settings can be stored to the sound's memory (in Sound mode) or a Favorite memory for convenient recall. Please refer to pages 82 and 101 for more information.

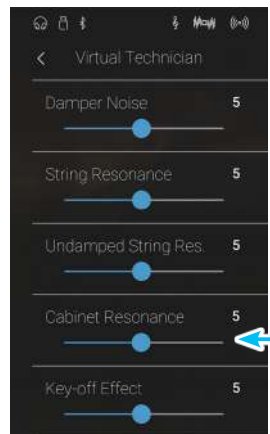

Cabinet Resonance slider

8 Key-off Effect

When playing an acoustic piano – particularly in the bass region of the keyboard – if a key is played with force and released quickly, it is often possible to hear the faint sound of the damper touching the strings immediately before the vibrations are stopped.

In addition, the speed at which keys are lifted will also affect the character of the sound. For example, when lifting the keys quickly (e.g. staccato playing) the ‘release’ portion of the sound will be noticeably shorter than when lifting the keys slowly (e.g. legato playing).

The NV10 hybrid digital piano reproduces both characteristics, with the Key-off Effect setting allowing the volume of the key-off sound to be adjusted, and the key-off release speed detection to be turned on or off.

* This Virtual Technician setting will affect acoustic piano and electric piano sounds.

■ Adjusting the Key-off Effect volume

Long press and drag the slider to increase or decrease the volume of the Key-off Effect setting.

- * The Key-off Effect volume can be adjusted within the range of Off, 1~10, with higher values resulting in a more pronounced effect.
- * When the Key-Off Effect setting is set to Off, the key-off release speed detection will also be disabled, and the speed at which keys are lifted will not affect the character of the sound.
- * Any changes made to the Key-off Effect setting will remain until the power is turned off.
- * Preferred Key-off Effect settings can be stored to the sound’s memory (in Sound mode) or a Favorite memory for convenient recall. Please refer to pages 82 and 101 for more information.

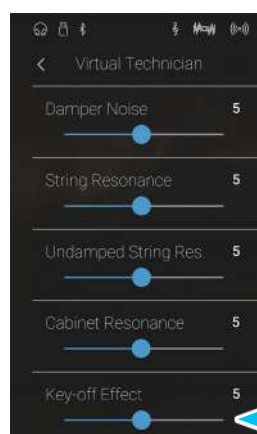

Key-off Effect slider

9 Fall-back Noise

Pianist Mode

Sound Mode

When playing an acoustic piano, it is often possible to hear the faint sound of the keyboard action returning (i.e. 'falling back') to the neutral position after a key is released.

The NV10 hybrid digital piano reproduces this sound, with the Fall-back Noise setting allowing the volume of this sound to be adjusted.

While the default value is intended to simulate the natural volume level of the keys as they return to their neutral position, it may occasionally be desirable to adjust the volume of this sound. For example, reducing the volume when playing very soft pieces, where the fall-back noise may become too prominent.

* This Virtual Technician setting will affect acoustic piano and harpsichord sounds.

■ Adjusting the Fall-back Noise volume

Long press and drag the slider to increase or decrease the volume of the Fall-back Noise setting.

- * The Fall-back Noise volume can be adjusted within the range of Off, 1~10, with higher values resulting in a more pronounced noise.
- * Any changes made to the Fall-back Noise setting will remain until the power is turned off.
- * Preferred Fall-back Noise settings can be stored to the sound's memory (in Sound mode) or a Favorite memory for convenient recall. Please refer to pages 82 and 101 for more information.

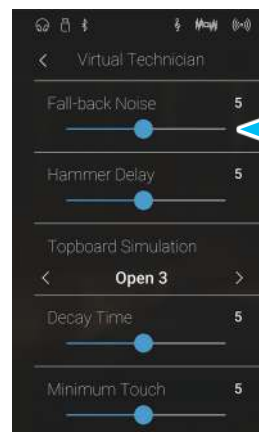

Fall-back Noise slider

10 Hammer Delay

Pianist Mode

Sound Mode

When playing pianissimo passages using an acoustic piano, there may be a perceived delay between a key being pressed and the hammer striking the strings.

If desired, the NV10 hybrid digital piano can recreate this delay, with the Hammer Delay setting allowing the delay length to be adjusted.

While the default value of 'Off' is intended to replicate a well-regulated concert grand piano, with an immediate connection between the keyboard and hammers, some players may find it desirable to introduce a minor delay, in order to mimic different types of piano or instruments with a slightly worn keyboard action.

* This Virtual Technician setting will affect acoustic piano sounds only.

■ Adjusting the Hammer Delay value

Long press and drag the slider to increase or decrease the value of the Hammer Delay setting.

- * The Hammer Delay value can be adjusted within the range of Off, 1~10, with higher values resulting in an increased delay.
- * Any changes made to the Hammer Delay setting will remain until the power is turned off.
- * Preferred Hammer Delay settings can be stored to the sound's memory (in Sound mode) or a Favorite memory for convenient recall. Please refer to pages 82 and 101 for more information.

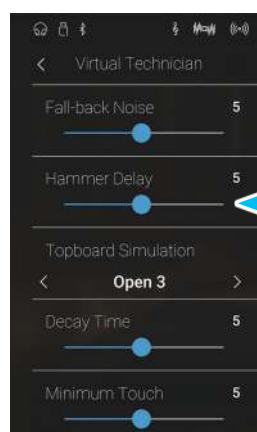

← Hammer Delay slider

11 Topboard Simulation

Sound Mode

When playing an acoustic grand piano, the position of the instrument's topboard (lid) affects both the volume and 'openness' of the tone produced. A fully open topboard allows sound waves to reflect off the polished lid surface and project into the room, while a closed lid has the opposite effect, resulting in a darker, more opaque tone.

The NV10 hybrid digital piano simulates these characteristics, with four different topboard positions.

* This Virtual Technician setting will affect acoustic piano sounds only.

■ Topboard positions

Topboard position	Description
Open 3 (default)	Simulates the character of a fully open topboard, with maximum sound projection.
Open 2	Simulates the character of a half open topboard, with reduced sound projection.
Open 1	Simulates the character of a partially open topboard, with limited sound projection.
Closed	Simulates the character of a closed topboard, with minimum sound projection.

■ Changing the Topboard position

Swipe left/right or tap the arrow buttons to change the Topboard position.

* The Topboard can be set to one of 4 positions.

The tonal character of the sound will change depending on the selected Topboard position.

* Any changes made to the Topboard setting will remain until the power is turned off.

* Preferred Topboard settings can be stored to the sound's memory (in Sound mode) or a Favorite memory for convenient recall. Please refer to pages 82 and 101 for more information.

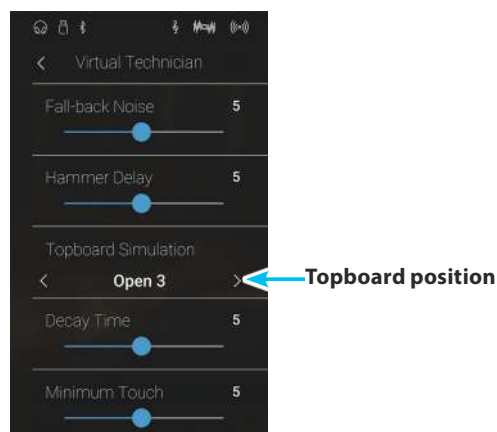

12 Decay Time

Sound Mode

When playing an acoustic grand piano, the length of the instrument influences the speed at which held notes decay, with longer grand pianos (i.e. longer strings) characterised by longer decay times.

The NV10 hybrid digital piano simulates this characteristic, with the Decay Time setting allowing the length of decay while keys are pressed to be adjusted.

* This Virtual Technician setting will affect all sounds.

■ Adjusting the Decay Time value

Long press and drag the slider to increase or decrease the value of the Decay Time setting.

- * The Decay Time value can be adjusted within the range of 1~10, with larger values resulting in increased decay times.
- * Any changes made to the Decay Time setting will remain until the power is turned off.
- * Preferred Decay Time settings can be stored to the sound's memory (in Sound mode) or a Favorite memory for convenient recall. Please refer to pages 82 and 101 for more information.

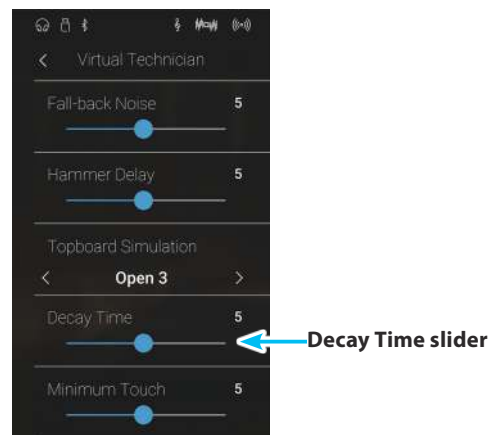

13 Minimum Touch

Pianist Mode

Sound Mode

The Minimum Touch setting allows the minimum key velocity required to produce a sound to be adjusted. By default, this setting recreates the extremely fine touch sensitivity of a concert grand piano, allowing a very soft sound to be produced with the slightest of key touches. However, it may be desirable to reduce this sensitivity, when wishing to recreate the sensitivity of a small grand piano or an upright piano.

* This Virtual Technician setting will affect acoustic piano and electric piano sounds.

■ Adjusting the Minimum Touch value

Long press and drag the slider to increase or decrease the value of the Minimum Touch setting.

- * The Minimum Touch value can be adjusted within the range of 1~20, with larger values requiring greater key force in order to produce a sound. For example, a value of 10 will require the keyboard to be played with a velocity of 10 or above in order to produce a sound.
- * Any changes made to the Minimum Touch setting will remain until the power is turned off.
- * Preferred Minimum Touch settings can be stored to the sound's memory (in Sound mode) or a Favorite memory for convenient recall. Please refer to pages 82 and 101 for more information.

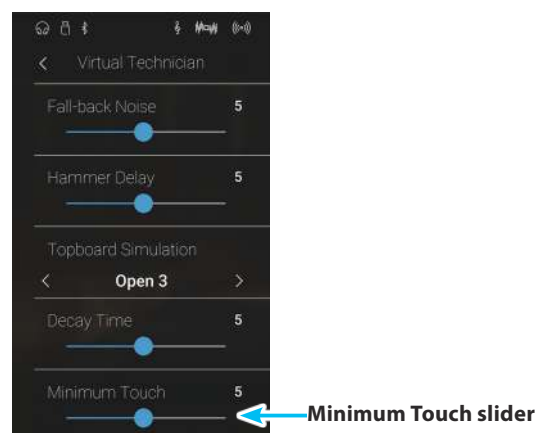

14 Stretch Tuning

Stretch tuning is a piano-specific tuning method used by acoustic piano technicians in which the lower octaves are tuned slightly flatter and the upper octaves are tuned slightly sharper to match the natural harmonics of an acoustic piano.

The Stretch Tuning setting allows the degree of stretch tuning to be adjusted when Equal temperament is selected, or for stretch tuning to be completely disabled. It is also possible to create custom tuning methods by adjusting the pitch of each individual key.

* This Virtual Technician setting will affect all sounds.

■ Stretch Tuning setting

Stretch Tuning	Description
Off	Stretch tuning is disabled.
Normal (default)	Normal stretch tuning is applied.
Wide	Wide stretch tuning is applied.
User	A custom tuning method, allowing the pitch of each key to be individual tuned.

■ Changing the Stretch Tuning type

Swipe left/right or tap the arrow buttons to change the Stretch Tuning type.

* The Stretch Tuning type can be set to one of 4 types.

The tonal character of the sound will change depending on the selected Stretch Tuning type.

* Any changes made to the Stretch Tuning setting will remain until the power is turned off.

* Preferred Stretch Tuning settings can be stored to the sound's memory (in Sound mode) or a Favorite memory for convenient recall. Please refer to pages 82 and 101 for more information.

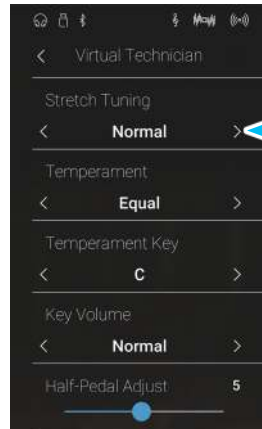

Stretch Tuning type

User Tuning

Sound Mode

The User Tuning function allows each of the 88 keys to be tuned individually.

■ Adjusting the User Tuning function

1. Swipe left/right or tap the arrow buttons to select the User Tuning type.

* In Sound mode, User Tuning is performed and stored independently for each sound.

2. Tap the [Edit] button.

The User Tuning screen will be shown.

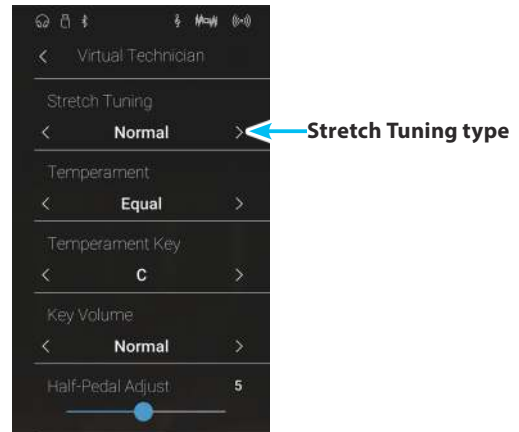

3. Tap [Key], then press the desired key on the keyboard to be adjusted.

The selected key should be shown.

4. Long press and drag the slider to adjust the User Tuning value for the selected key.

* The User Tuning value can be adjusted within the range of -50~+50. A value of +20 indicates a pitch increase of 20 cents.

5. Tap the [BACK] button to return to the Virtual Technician menu.

* If desired, tap [Save to Sound] to ensure that the User Tuning type is retained after the instrument's power is turned off.

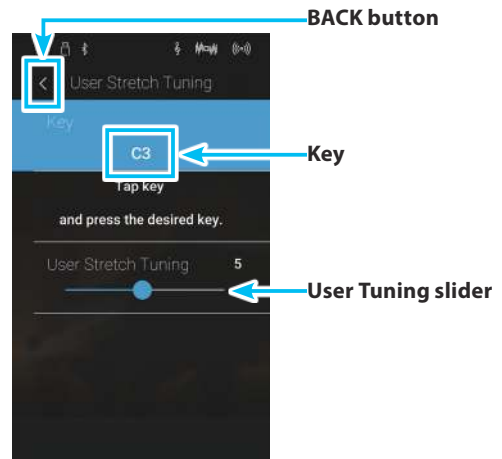

15 Temperament

The Temperament setting allows the tuning system used by the NV10 hybrid digital piano to be changed from the modern 'Equal Temperament' standard to one of the various temperaments popularised during the Renaissance and Baroque periods. It is also possible to create customised temperaments using the User Temperament function.

* This Virtual Technician setting will affect all sounds.

■ Temperament types

Temperament type	Description
Equal Temperament (default) (Equal)	This temperament is the most popular tuning method, and divides the scale into twelve equal semi-tones. This produces the same chordal intervals in all twelve keys, and has the advantage of limitless modulation of the key. However, the tonality of each key becomes less characteristic and no chord is in pure consonance.
Pure Temperament (Pure Major/Pure Minor)	This temperament, which eliminates dissonances for thirds and fifths, is still popular in choral music because of its perfect harmony. Any key modulation will result in dissonances. * The key of the temperament and major/minor setting must be correctly matched.
Pythagorean Temperament (Pythagorean)	This temperament, which uses mathematical ratios to eliminate dissonance for fifths, is very limited for use with chords, but produces very characteristic melodic lines.
Meantone Temperament (Meantone)	This temperament, which uses a mean between a major and minor whole tone to eliminate dissonance for thirds, was devised to eliminate the lack of consonances experienced with certain fifths for the Mersenne pure temperament. It produces chords that are more beautiful than those played with equal temperament.
Werckmeister Temperament (Werckmeister) Kirnberger Temperament (Kirnberger)	These two temperaments are placed in between Meantone and Pythagorean. For music with few accidentals, this temperament produces the beautiful chords of the mean tone, but as accidentals increase, the temperament produces the characteristic melodies of the Pythagorean temperament. It is used primarily for classical music written in the Baroque era to revive the original characteristics.
User Temperament (User)	A custom temperament, created by raising or lowering the pitch of each note in the scale.

■ Changing the Temperament type

Swipe left/right or tap the arrow buttons to change the Temperament type.

- * The Temperament type can be set to one of 8 types.
- * Any changes made to the Temperament setting will remain until the power is turned off.
- * Preferred Temperament settings can be stored to the sound's memory (in Sound mode) or a Favorite memory for convenient recall. Please refer to pages 82 and 101 for more information.

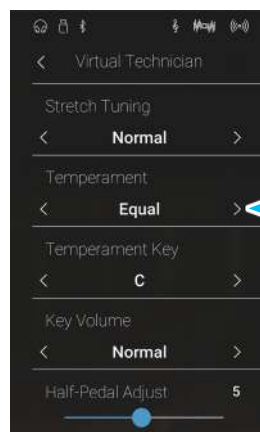

← Temperament type

User Temperament

The User Temperament function allows custom temperaments to be created.

■ Adjusting the User Temperament function

1. Swipe left/right or tap the arrow buttons to select the User Temperament type.
2. Tap the [Edit] button.

The User Temperament screen will be shown.

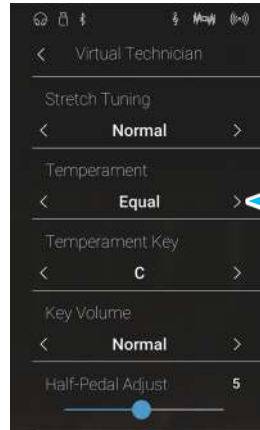

← Temperament type

3. Tap [Key], then press the desired key on the keyboard to be adjusted.

The selected key should be shown.

4. Long press and drag the slider to adjust the User Temperament value for the selected key.

* The User Temperament value can be adjusted within the range of -50~+50. A value of +20 indicates a pitch increase of 20 cents.

5. Tap the [Back] button to return to the Virtual Technician menu.

* If desired, tap [Save to Sound] to ensure that the User Temperament type is retained after the instrument's power is turned off.

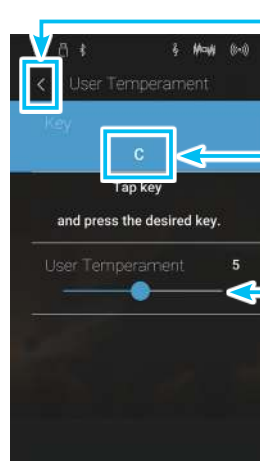

← BACK button

← Key

← User Temperament slider

16 Temperament Key

Sound Mode

The Temperament Key setting allows the key of the selected temperament to be specified. When using a temperament other than Equal temperament, use this setting to specify the key signature of the piece.

- * This Virtual Technician setting will affect all sounds.
- * This setting will only affect the 'balance' of the tuning system, the pitch of the keyboard will remain unchanged.

■ Changing the Temperament Key

Swipe left/right or tap the arrow buttons to change the Temperament Key.

- * The Temperament Key can be set within the range of C to B.
- * Any changes made to the Temperament Key setting will remain until the power is turned off.
- * Preferred Temperament Key settings can be stored to the sound's memory (in Sound mode) or a Favorite memory for convenient recall. Please refer to pages 82 and 101 for more information.

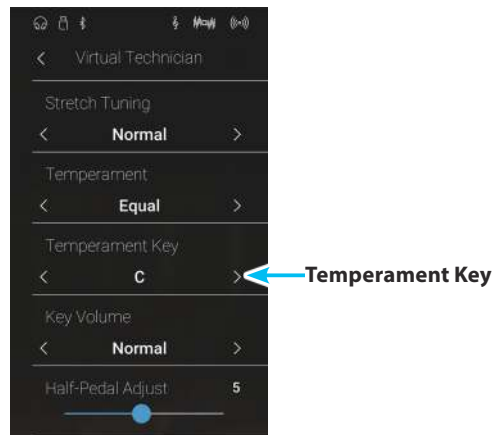

17 Key Volume

Pianist Mode

Sound Mode

The Key Volume setting allows the volume of different regions of the keyboard to be subtly reduced. There are four different damping presets available, with an additional 'User' setting allowing players to perform subtle volume adjustments on each individual key.

While the default 'Normal' key volume setting should be appropriate for a broad range of musical genres, it may be desirable to experiment with different damping presets, or the User setting to attenuate or amplify the volume of individual keys.

* This Virtual Technician setting will affect all sounds.

■ Key Volume types

Key Volume	Description
Normal (default)	An evenly balanced volume throughout the keyboard.
High Damping	Gradually reduces the volume of the keyboard towards the treble region.
Low Damping	Gradually reduces the volume of the keyboard towards the bass region.
High & Low Damping	Gradually reduces the volume of the keyboard in both the treble and bass regions.
Center Damping	Gradually reduces the volume of the keyboard in the central region.
User	A custom keyboard volume, allowing the volume of each key to be individually adjusted.

■ Changing the Key Volume type

Swipe left/right or tap the arrow buttons to change the Key Volume type.

- * The Key Volume type can be set to one of 6 types.
- * Any changes made to the Key Volume setting will remain until the power is turned off.
- * Preferred Key Volume settings can be stored to the sound's memory (in Sound mode) or a Favorite memory for convenient recall. Please refer to pages 82 and 101 for more information.

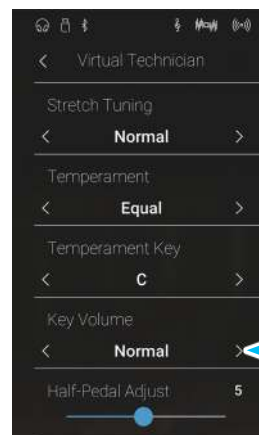

Key Volume type

User Key Volume

Pianist Mode

Sound Mode

The User Key Volume settings allows the volume of each of the 88 keys to be adjusted individually.

■ Adjusting the User Key Volume function

1. Swipe left/right or tap the arrow buttons to select the User Key Volume type.

* User Key Volume is performed and stored independently for each sound.

2. Tap the [Edit] button.

The User Key Volume screen will be shown.

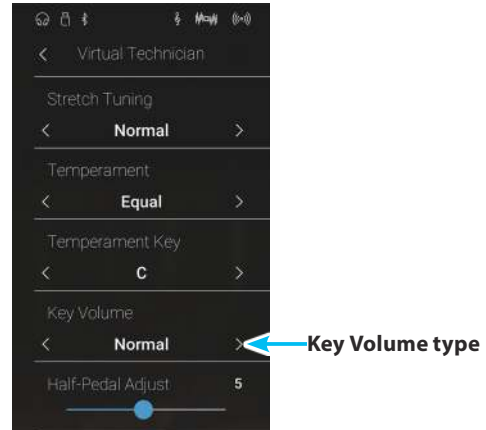

3. Tap [Key], then press the desired key on the keyboard to be adjusted.

The selected key should be shown.

4. Long press and drag the slider to adjust the User Key Volume value for the selected key.

* The User Key Volume value can be adjusted within the range of -50~+50, with lower values attenuating the sound and higher values amplifying the sound.

5. Tap the [Back] button to return to the Virtual Technician menu.

* If desired, tap [Save to Sound] to ensure that the User Key Volume type is retained after the instrument's power is turned off.

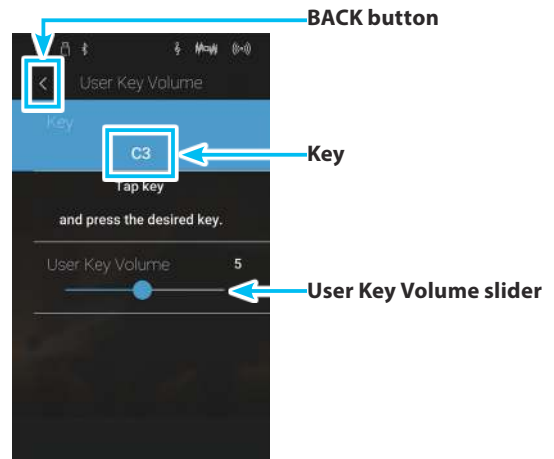

18 Half-Pedal Adjust

Pianist Mode

Sound Mode

The Half-Pedal Adjust setting allows the point at which the damper/sustain pedal becomes effective (i.e. when the dampers of the piano begin to lift from the strings) to be adjusted. This setting may be useful for pianists that habitually rest their right foot on the damper/sustain pedal, but do not necessarily wish to sustain the sound.

* This Virtual Technician setting will affect all sounds.

■ Adjusting the Half-Pedal Adjust value

Long press and drag the slider to increase or decrease the value of the Half-Pedal Adjust setting.

- * The Half-Pedal Adjust value can be adjusted within the range of 1~10, with higher values resulting in a later damper pedal point.
- * Any changes made to the Half-Pedal Adjust setting will remain until the power is turned off.
- * Preferred Half-Pedal Adjust settings can be stored to the sound's memory (in Sound mode) or a Favorite memory for convenient recall. Please refer to pages 82 and 101 for more information.

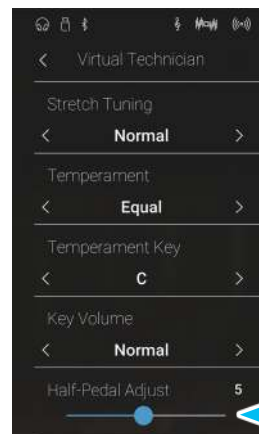

Half-Pedal Adjust slider

19 Soft Pedal Depth

Pianist Mode

Sound Mode

The Soft Pedal Depth setting adjusts the extent to which the soft (left) pedal of the NV10 hybrid digital piano softens the sound of played notes.

While the default value is intended to replicate the effectiveness of a concert grand Una Corda pedal, it may be desirable for players to increase or decrease the value of this setting to suit their playing style.

On an acoustic piano, pressing this Una Corda pedal shifts the keyboard action slightly to the right, causing the hammers to strike two strings instead of the usual three, thus reducing the volume of each note.

* This Virtual Technician setting will affect all sounds.

■ Adjusting the Soft Pedal Depth value

Long press and drag the slider to increase or decrease the value of the Soft Pedal Depth setting.

- * The Soft Pedal Depth value can be adjusted within the range of 1~10, with higher values resulting in a softer sound.
- * Any changes made to the Soft Pedal Depth setting will remain until the power is turned off.
- * Preferred Soft Pedal Depth settings can be stored to the sound's memory (in Sound mode) or a Favorite memory for convenient recall. Please refer to pages 82 and 101 for more information.

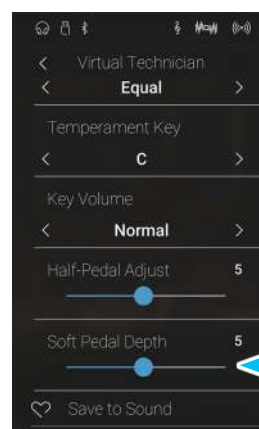

Soft Pedal Depth slider

Sound Settings

The Sound Settings menu contains settings for adjusting the overall sound of the instrument, such as pitch, tone control, and headphone enhancements.

* The Sound Settings menu settings in Pianist mode and Sound mode are shared (i.e. adjustments made in Pianist mode will also affect Sound mode and vice versa).

Tap [Sound Settings] to open the Sound Settings menu.

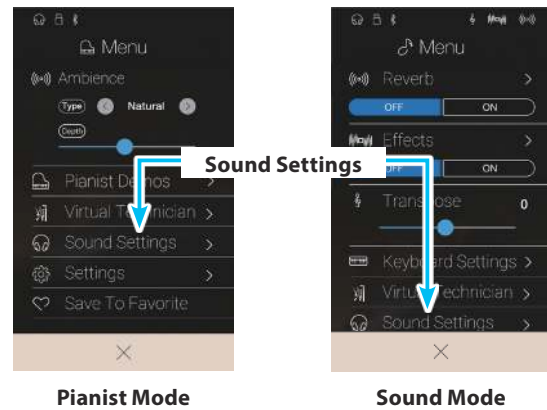

■ Sound Settings menu

No.	Setting	Description	Default setting	Page no.
1	Tuning*	Adjust the pitch of the instrument in 0.5 Hz steps.	440.0 Hz	p. 124
2	Damper Hold*	Change the effect of pressing the sustain pedal on organ, string, etc. sounds.	Off	p. 124
3	Tone Control	Adjust the EQ settings of the instrument's sound.	Off	p. 125
4	Speaker Volume	Change the maximum volume level of the speaker output.	Normal	p. 127
5	Line In Level	Adjust the input volume of the Line In connectors.	0 dB.	p. 128
6	Wall EQ	Optimise the instrument's speaker system based on instrument placement.	Off	p. 129
7	SHS Mode	Select the desired SHS (Spatial Headphone Sound) mode.	Normal	p. 130
8	Phones Type	Select the type of headphones to be used with the instrument.	Normal	p. 131
9	Phones Volume	Change the maximum volume level of the headphones output.	Normal	p. 132

* The Tuning and Damper Hold settings will be hidden in Pianist mode.

1 Tuning

The Tuning setting allows the overall pitch of the NV10 hybrid digital piano to be raised and lowered in 0.5 Hz steps, and may therefore prove useful when playing with other instruments.

* The Tuning setting will be hidden in Pianist mode.

■ Adjusting the Tuning value

Swipe up/down or tap the arrow buttons above and below each digit to adjust the Tuning value.

- * The Tuning value can be adjusted in 0.5 Hz increments within the range of 427.0~453.0 Hz.
- * Any changes made to the Tuning setting will remain until the power is turned off.
- * Preferred Tuning settings can be stored to a Favorite memory for convenient recall. Please refer to page 82 for more information.

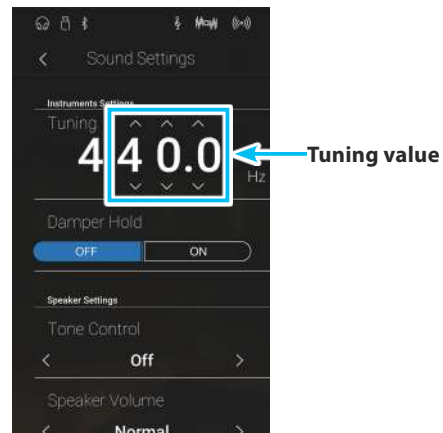

2 Damper Hold

The Damper Hold setting is used to determine whether sounds such as organ or strings should be sustained continuously when the damper pedal is pressed, or whether these sounds should decay, naturally.

* The Tuning setting will be hidden in Pianist mode.

■ Damper Hold setting

Damper Hold	Description
Off (default)	Organ, strings, etc. sounds will gradually decay, even while the sustain pedal is pressed.
On	Organ, strings, etc. sounds will be sustained continuously while the sustain pedal is pressed.

■ Changing the Damper Hold setting

Tap the [ON/OFF] buttons to turn Damper Hold on/off.

- * Any changes made to the Damper Hold setting will remain until the power is turned off.
- * Preferred Damper Hold settings can be stored to a Favorite memory for convenient recall. Please refer to page 82 for more information.

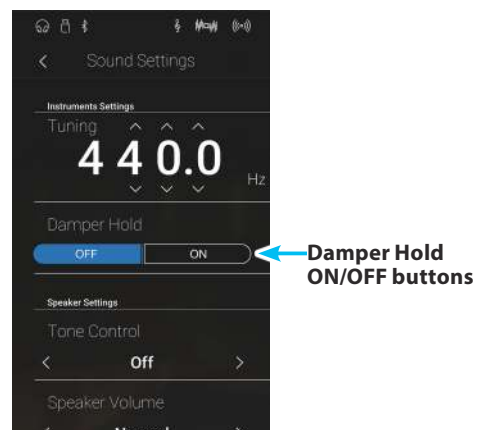

3 Tone Control

The Tone Control setting allows the overall sound character of the NV10 hybrid digital piano to be adjusted to provide the best sound quality within the area that the instrument is located. There are five different preset EQ settings available, with an additional 'User' setting allowing finer control over the different frequency bands.

■ Tone Control setting

Tone Control type	Description
Off (default)	Tone control adjustment is not applied.
Brilliance	Adjusts the overall brightness of the sound, independently of the Virtual Technician 'Voicing' parameter.
Loudness	Emphasises frequencies to retain the instrument's sound character when playing at low volume levels.
Bass Boost	Emphasises low-range frequencies, creating a deeper sound.
Treble Boost	Emphasises high-range frequencies, creating a brighter sound.
Mid Cut	Reduces mid-range frequencies, creating a clearer sound.
User	Allows the low, mid, and high-range frequency bands to be adjusted separately.

■ Changing the Tone Control type

Swipe left/right or tap the arrow buttons to change the Tone Control type.

- * The Tone Control can be set to one of 7 types.
- * Any changes made to the Tone Control setting will remain until the power is turned off.
- * Preferred Tone Control settings can be stored to a Favorite memory for convenient recall. Please refer to page 82 for more information.

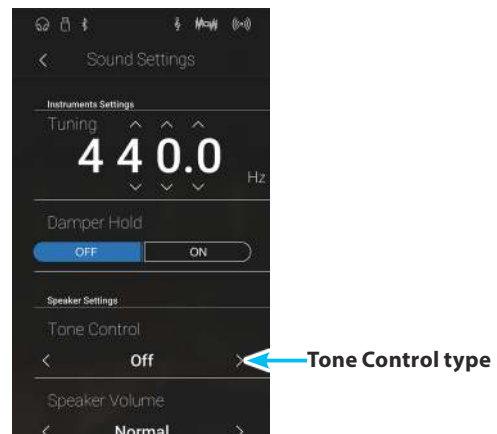

■ Adjusting the Brilliance value

1. Swipe left/right or tap the arrow buttons to select the Brilliance tone control type.
2. Tap the [Edit] button.

The Brilliance screen will be shown.
3. Long press and drag the slider to adjust the overall brightness of the sound.

* The Brilliance value can be adjusted within the range of -10~+10, with lower values creating a mellower sound and higher values creating a brighter sound.
4. Tap the [Back] button to return to the Sound Settings menu.

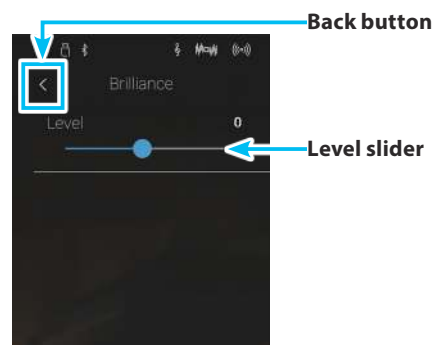
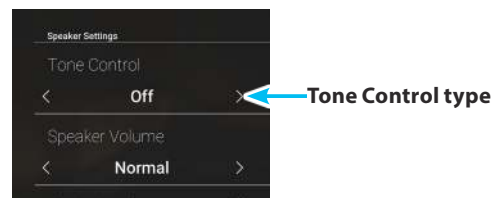

User Tone Control

The User Tone Control option allows finer control over the instrument's sound character, allowing the volume of four frequency bands to be adjusted individually. It is also possible to adjust the frequency range of the mid-low and mid-high frequency bands.

User Tone Control setting

No.	User Tone Control	Description
1	Low	Adjusts the volume of the low range frequency band (20~100 Hz).
2	Mid-low Frequency	Adjusts the frequency of the mid-low band (355~3150 Hz).
	Mid-low dB	Adjusts the volume of the mid-low range frequency band.
3	Mid-high Frequency	Adjusts the frequency of the mid-high band (355~3150 Hz).
	Mid-high dB	Adjusts the volume of the mid-high range frequency band.
4	High	Adjusts the volume of the high range frequency band (5000~20000 Hz).

Adjusting the User Tone Control setting

1. Swipe left/right or tap the arrow buttons to select the User tone control type.
2. Tap the [Edit] button.

The User Tone Control screen will be shown.

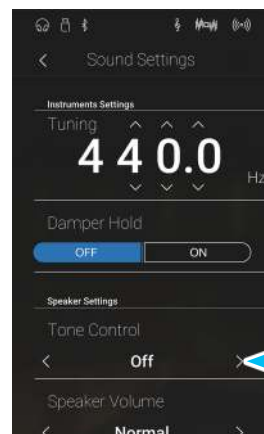

3. Long press and drag the sliders to adjust the volume of the different frequency bands.

* Each frequency band can be adjusted within the range of -6 dB~+6 dB.

4. Swipe left/right or tap the arrow buttons to adjust the Mid-low/Mid-high frequency.

* Any changes made to the Tone Control setting will remain until the power is turned off.

* Preferred Tone Control settings can be stored to a Favorite memory for convenient recall. Please refer to page 82 for more information.

5. Tap the [BACK] button to return to the Sound Settings menu.

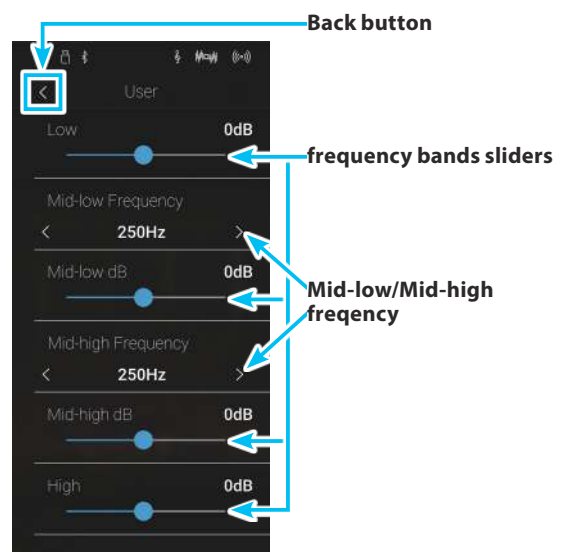

4 Speaker Volume

The Speaker Volume setting allows the maximum volume level of the NV10 hybrid digital piano’s speaker output to be reduced, providing finer adjustment control over the master volume. This setting can also function as a volume limiter, preventing the instrument from being played too loudly in the home or classroom etc.

* This setting does not affect the headphones or Line Out volume.

■ Speaker Volume setting

Speaker Volume	Description
Normal (default)	The instrument’s speakers will output sound at the normal volume level.
Low	The instrument’s speakers will output sound at a reduced volume level.

■ Changing the Speaker Volume setting

Swipe left/right or tap the arrow buttons to change the Speaker Volume setting.

- * Any changes made to the Speaker Volume setting will remain until the power is turned off.
- * Preferred Speaker Volume settings can be stored to a Favorite memory for convenient recall. Please refer to page 82 for more information.

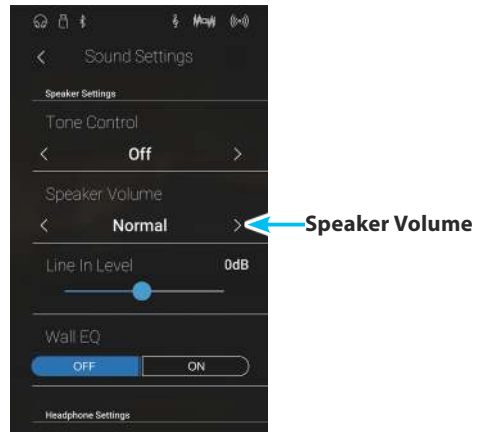

5 Line In Level

The Line In Level setting allows the volume level of the instrument's Line In input jacks to be adjusted digitally. This setting may be useful when using the USB Recorder function and attempting to balance an external audio source with the instrument's sound.

* The Line In Level can also be adjusted by using the LEVEL knob, located on the jack panel. Please refer to page 155 for more information.

■ Adjusting the Line In Level setting

Long press and drag the slider to adjust the Line In Level setting.

* The Line In Level can be adjusted within the range of -10 dB~+10 dB.

* Any changes made to the Line In Level setting will remain until the power is turned off.

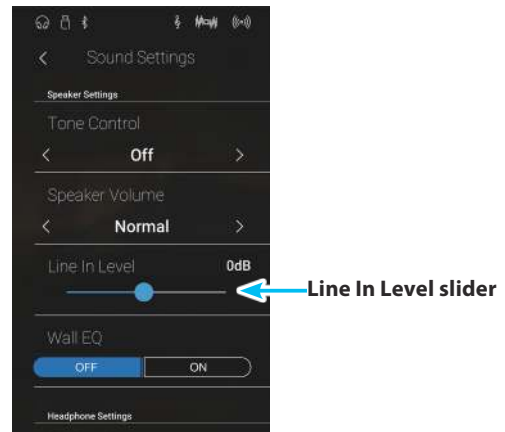

■ Line In Level setting vs Line In LEVEL knob

The NV10 hybrid digital piano provides two methods of adjusting the level of the Line In audio: the Line In LEVEL knob (located beside the Line In jacks on the jack panel), and the Line In Level setting. The LEVEL knob is used to adjust the analogue volume of the sound entering the instrument, while the Line In Level setting adjusts the digital volume of the sound once it is 'inside' the instrument.

To ensure the Line In audio is of a high quality, it is recommended to set the volume of the external audio device (for example a tablet) to a high level, then adjust the instrument's Line In LEVEL knob to a comfortable level, without distortion. If it is necessary to further increase or decrease the volume of the external audio, the Line In Level setting can then be used as desired.

6 Wall EQ

The Wall EQ setting optimises the sound character of the soundboard speaker depending on whether the NV10 hybrid digital piano (back) is placed beside a wall, or in an area away from a wall.

* This setting does not affect the headphones or Line Out output.

■ Wall EQ setting

Wall EQ	Description
Off (default)	Optimise the speaker system for placing the NV10 hybrid digital piano in an area away from a wall.
On	Optimise the speaker for placing the NV10 hybrid digital piano beside a wall.

■ Changing the Wall EQ setting

Tap the [ON/OFF] buttons to turn Wall EQ on/off.

* Any changes made to the Wall EQ setting will remain until the power is turned off.

* Preferred Wall EQ settings can be stored to a Favorite memory for convenient recall. Please refer to page 82 for more information.

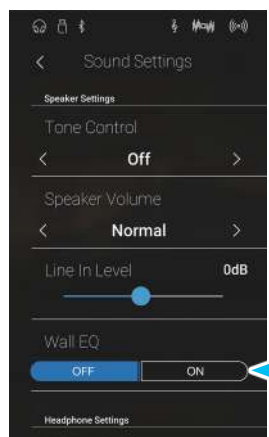

Wall EQ ON/OFF buttons

7 SHS Mode

Spatial Headphone Sound (SHS) is a special feature of the NV10 hybrid digital piano that enhances the depth and realism of the acoustic piano sound when listening through headphones or earphones.

The SHS Mode setting allows the player to select from one of three different acoustic presets that adjust the spatial positioning of the sound, while also helping to reduce auditory fatigue when using earphones or headphones for extended periods of time.

* This setting does not affect the speaker or Line Out sound.

SHS Mode setting

SHS Mode	Description
Off	Disable the Spatial Headphone Sound feature.
Forward	Front focused, somewhat narrow spatial positioning.
Normal (default)	Naturally balanced spatial positioning that is neither forward nor wide.
Wide	Wide, very open spatial positioning.

Changing the SHS Mode setting

Swipe left/right or tap the arrow buttons to change the SHS Mode setting.

- * The SHS Mode can be set to one of 3 types, or turned off.
- * Any changes made to the SHS Mode setting will remain until the power is turned off.
- * Preferred SHS Mode settings can be stored to a Favorite memory for convenient recall. Please refer to page 82 for more information.

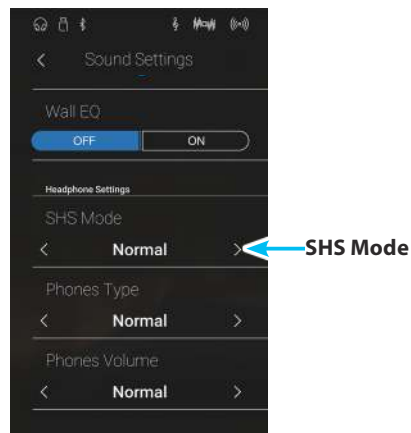

8 Phones Type

The Phones Type setting optimises the sound of the NV10 hybrid digital piano when listening through different types of headphones or earphones.

* This setting does not affect the speaker or Line Out sound.

■ Phones Type setting

Phones Type	Description
Normal (default)	Disables headphone optimisation.
Open	Optimises the sound for open type headphones.
Semi-open	Optimises the sound for semi-open type headphones.
Closed	Optimises the sound for closed type headphones.
Inner-ear	Optimises the sound for inner-ear type headphones.
Canal	Optimises the sound for canal-type headphones.

■ Changing the Phones Type setting

Swipe left/right or tap the arrow buttons to change the Phones Type setting.

- * The Phones Type can be set to one of 6 types.
- * Any changes made to the Phones Type setting will remain until the power is turned off.
- * Preferred Phones Type settings can be stored to a Favorite memory for convenient recall. Please refer to page 82 for more information.

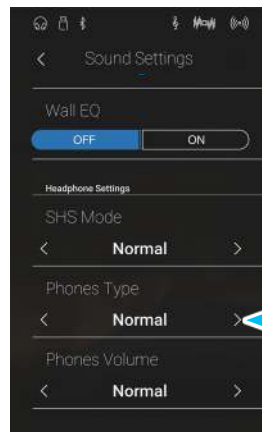

9 Phones Volume

The Phones Volume setting allows the maximum volume level of the headphones output to be increased.

The default setting for Phones Volume is 'Normal' in order to protect an individual's ears from excessive volume levels. The 'High' setting may be selected when using headphones with a high impedance, or in situations where it is desirable to increase the maximum volume level of the headphones output.

* This setting does not affect the speaker or Line Out sound.

■ Phones Volume setting

Phones Volume	Description
Normal (default)	The instrument's headphone connectors will output sound at the normal volume level.
High	The instrument's headphone connectors will output sound at an increased volume level.

■ Changing the Phones Volume setting

Swipe left/right or tap the arrow buttons to change the Phones Volume setting.

- * Any changes made to the Phones Volume setting will remain until the power is turned off.
- * Preferred Phones Volume settings can be stored to a Favorite memory for convenient recall. Please refer to page 82 for more information.

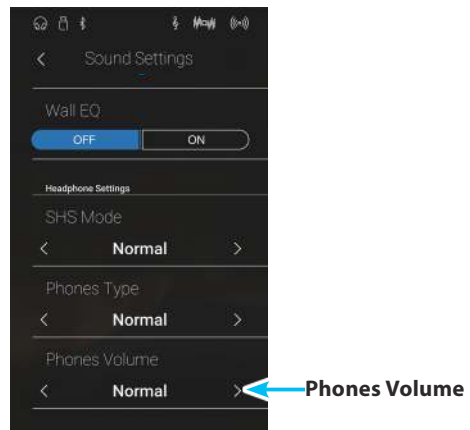

System Settings

The System Settings menu contains settings and functions related to the instrument's operation, such as Bluetooth and MIDI connectivity, USB functions, LCD appearance, etc.

* The System Settings menu settings in Pianist mode and Sound mode are shared (i.e. adjustments made in Pianist mode will also affect Sound mode and vice versa).

Tap [System Settings] to open the System Settings menu.

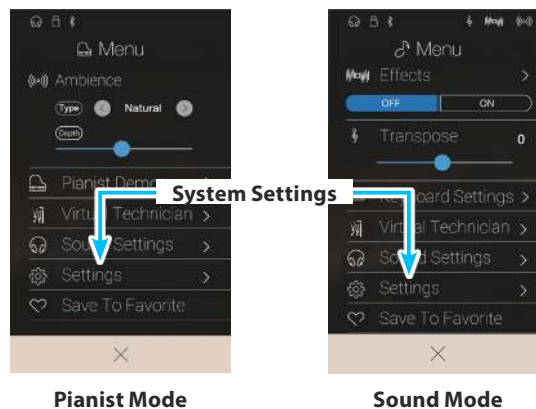

System Settings menu

No.	Setting	Description	Default setting	Page no.
1	Bluetooth MIDI	Enable/disable the instrument's Bluetooth MIDI function.	On	p. 134
2	Bluetooth Audio	Enable/disable the instrument's Bluetooth Audio function.	On	p. 135
3	Bluetooth Audio Volume	Adjust the volume of Bluetooth Audio playback.	0 dB	p. 136
4	Rename File*	Rename a file stored on a USB memory device.	-	p. 137
5	Delete File*	Delete a file stored on a USB memory device.	-	p. 138
6	USB Format*	Format a USB memory device, erasing all stored data.	-	p. 139
7	MIDI Channel	Specify the channel that is used to transmit/receive MIDI information.	1	p. 142
8	Send PGM Change #	Send a MIDI program change number from 1 to 128.	1	p. 143
9	Local Control	Specify whether internal sounds will be heard when the keyboard is pressed.	On	p. 143
10	Trans. PGM Change	Specify whether program change data is sent when sounds are changed.	On	p. 144
11	Multi-timbral Mode	Specify whether the instrument can receive Multi-timbral MIDI information.	Off	p. 145
12	Channel Mute	Specify which channels (1-16) are activated to receive MIDI information.	Play All	p. 145
13	LCD Contrast	Adjust the contrast of the instrument's LCD touchscreen display.	5	p. 146
14	Auto Display Off	Enable/disable the touchscreen display's auto off function.	Off	p. 146
15	Auto Power Off	Enable/disable the instrument's Auto Power Off energy saving function.	-	p. 147
16	Factory Reset	Restore all panel settings to the original factory configuration.	-	p. 148

* USB functions will only be visible when a USB memory device is connected to the NV10 hybrid digital piano.

1 Bluetooth® MIDI

The Bluetooth MIDI setting is used to enable/disable the NV10 hybrid digital piano's Bluetooth MIDI function. When enabled, the NV10 hybrid digital piano can be connected to smart phones, tablets, and other smart devices to facilitate wireless MIDI communication, allowing a wide range of music-related apps to be enjoyed using the instrument.

* Availability of Bluetooth MIDI function dependent on market location.

■ Bluetooth MIDI setting

Bluetooth MIDI	Description
Off	The instrument's Bluetooth MIDI function will be turned off.
On (default)	The instrument's Bluetooth MIDI function will be turned on.

■ Changing the Bluetooth MIDI setting

Tap the [ON/OFF] buttons to turn Bluetooth MIDI on/off.

* Any changes made to the Bluetooth MIDI setting will remain until the power is turned off.

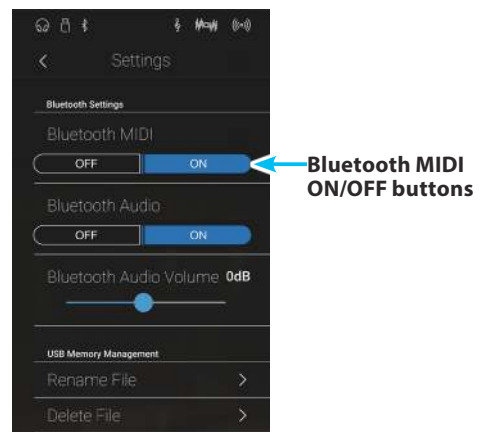

■ Connecting the NV10 hybrid digital piano to a smart device using Bluetooth MIDI

After enabling the Bluetooth MIDI function of the NV10 hybrid digital piano, enable Bluetooth communications on the smart device, then open the desired MIDI app. After a few seconds 'NV10' should appear in the app's device list. Tap the NV10 entry to connect the instrument to the smart device. It should now be possible for MIDI apps to communicate wirelessly with the NV10 hybrid digital piano.

* When the NV10 hybrid digital piano is connected to a smart device via Bluetooth MIDI, the USB MIDI and MIDI IN/OUT connectors will be disabled.

* Please check for Bluetooth MIDI compatibility with the smart device manufacturer and app developer.

* For a list of potential issues and recommended solutions when using Bluetooth communications, please refer to page 158 of this owner's manual.

* For more detailed instructions regarding Bluetooth connectivity, please refer to the supplementary Bluetooth® Connectivity Guide, available from the Kawai Global website: <http://www.kawai-global.com/support/bluetooth>

2 Bluetooth® Audio

The Bluetooth Audio setting is used to enable/disable the NV10 hybrid digital piano's Bluetooth Audio function. When enabled, the NV10 hybrid digital piano can be connected to smart phones, tablets, and other smart devices to facilitate wireless audio communication, allowing music stored on a device to be played through the instrument's speaker system/headphones.

* Availability of Bluetooth Audio function dependent on market location.

When using the USB audio recorder function, the Bluetooth Audio stream will also be mixed with the instrument's internal sound and recorded to the MP3/WAV file.

■ Bluetooth Audio setting

Bluetooth Audio	Description
Off	The instrument's Bluetooth Audio function will be turned off.
On (default)	The instrument's Bluetooth Audio function will be turned on.

■ Changing the Bluetooth Audio setting

Tap the [ON/OFF] buttons to turn Bluetooth Audio on/off.

* Any changes made to the Bluetooth Audio setting will remain until the power is turned off.

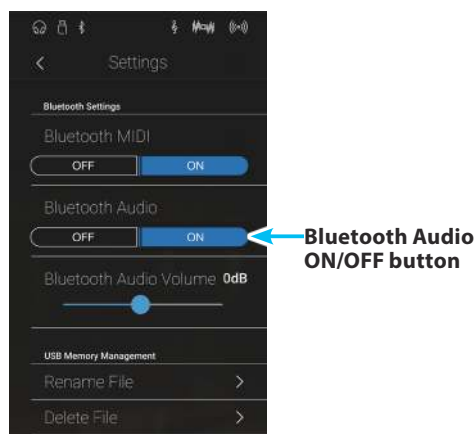

■ Connecting the NV10 hybrid digital piano to a smart device using Bluetooth Audio

After enabling the Bluetooth Audio function of the NV10 hybrid digital piano, enable Bluetooth communications on the smart device. After a few seconds 'NV10 Audio' should appear in the smart device's Bluetooth settings device list. Tap the NV10 Audio entry to connect the instrument to the smart device. It should now be possible for audio produced by the smart device to be heard through the instrument's speaker system/headphones.

* If loss of audio/connectivity or noise occurs, please check for Bluetooth Audio compatibility with the smart device manufacturer.

* For a list of potential issues and recommended solutions when using Bluetooth communications, please refer to page 158 of this owner's manual.

* For more detailed instructions regarding Bluetooth connectivity, please refer to the supplementary Bluetooth® Connectivity Guide, available from the Kawai Global website: <http://www.kawai-global.com/support/bluetooth>

3 Bluetooth® Audio Level

The Bluetooth Audio Level setting is used to increase or decrease the volume level of Bluetooth Audio playback. While it's generally preferable to adjust the audio volume level on the smart device itself, this setting may still be useful in certain situations.

■ Adjusting the Bluetooth Audio Level setting

Long press and drag the slider to adjust the Bluetooth Audio Level setting.

- * The Bluetooth Audio Level setting can be adjusted within the range of -15 dB~+15 dB.
- * Increasing the Bluetooth Audio Level setting above normal levels may result in distortion or reduced audio quality.
- * Any changes made to the Bluetooth Audio setting will remain until the power is turned off.

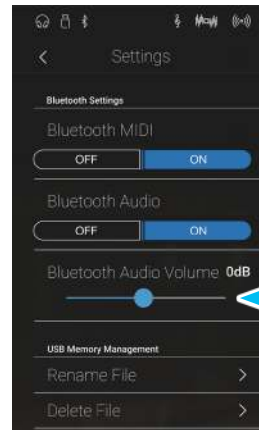

Bluetooth Audio Level slider

4 Rename File

The Rename File function is used to rename song (SMF/KSO) and audio (MP3/WAV) files stored on a USB memory device.

* This function will only be visible when a USB memory device is connected to the NV10 hybrid digital piano.

■ Renaming a file

1. Tap [Rename File].

The Rename File screen will be shown listing song and audio files stored on the USB device.

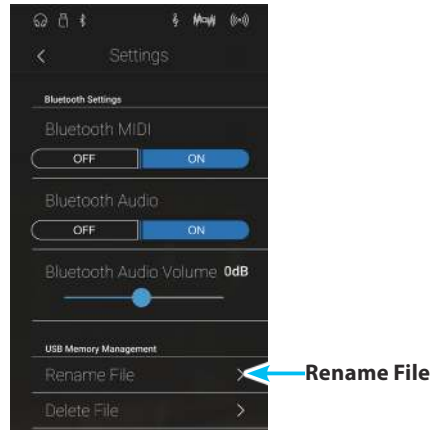

2. Tap the file to be renamed.

A filename input screen will be shown.

3. Enter the desired filename for the selected file using the onscreen keyboard, then tap the enter key to confirm the name.

* The filename length is limited to 12 characters.

To cancel the rename operation, press the [Back] button.

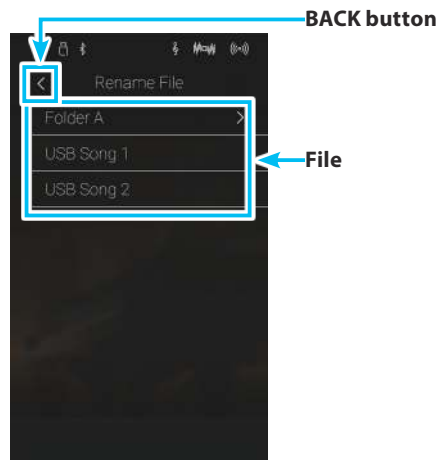

5 Delete File

The Delete File function is used to delete song, audio, and registration files stored on a USB memory device. Once a file has been deleted from the USB device it cannot be recovered.

* This function will only be visible when a USB memory device is connected to the NV10 hybrid digital piano.

■ Deleting a file

1. Tap [Delete File].

The Delete File screen will be shown listing song and audio files stored on the USB device.

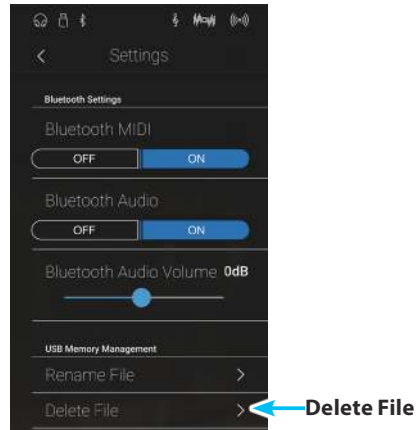

2. Tap the file to be deleted.

A confirmation box will be shown.

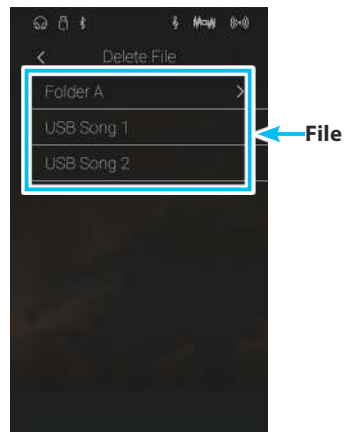

3. Tap the [Yes] button to confirm the delete operation, or the [No] button to cancel.

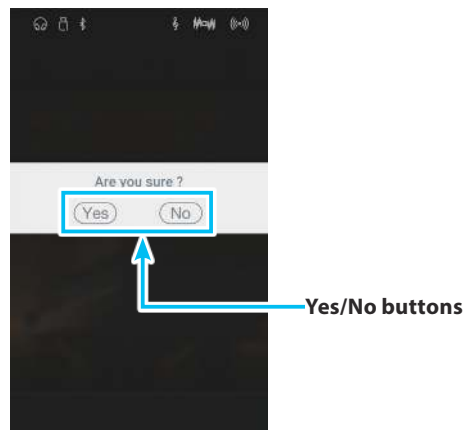

6 USB Format

The USB Format function is used to format the connected USB memory device, erasing all stored data.

* This function will only be visible when a USB memory device is connected to the NV10 hybrid digital piano.



The USB Format function will erase all data stored on the connected USB memory device. Exercise caution when using this function in order to prevent accidental data loss.

■ Formatting a USB device

1. Tap [Format USB].

A confirmation box will be shown.

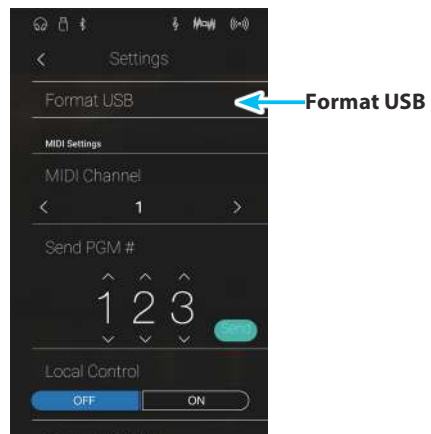

2. Tap the [Yes] button to confirm the format operation, or the [No] button to cancel.

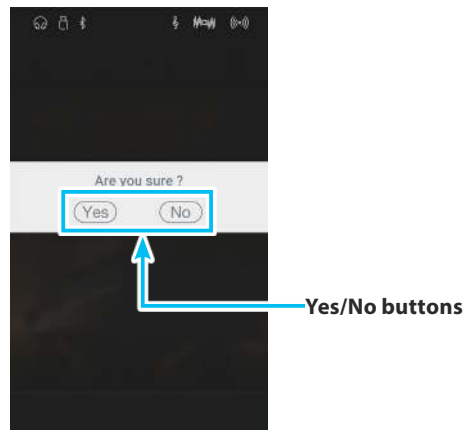

MIDI Overview

The term MIDI is an acronym for Musical Instrument Digital Interface, an international standard for connecting musical instruments, computers, and other devices to allow the exchange of performance data.

MIDI Terminals

MIDI terminal	Function
MIDI IN	Receiving note, program change, and other data.
MIDI OUT	Sending note, program change, and other data.

MIDI channels

MIDI uses channels to exchange data back and forth between MIDI devices. There are receive (MIDI IN) and transmit (MIDI OUT) channels. Most musical instruments or devices with MIDI functions are equipped with both MIDI IN and OUT jacks and are capable of transmitting and receiving data via MIDI. The receive channels are used to receive data from another MIDI device, and the transmit channels are used to transmit data to another MIDI device.

The illustration below shows three musical instruments, connected together using MIDI.

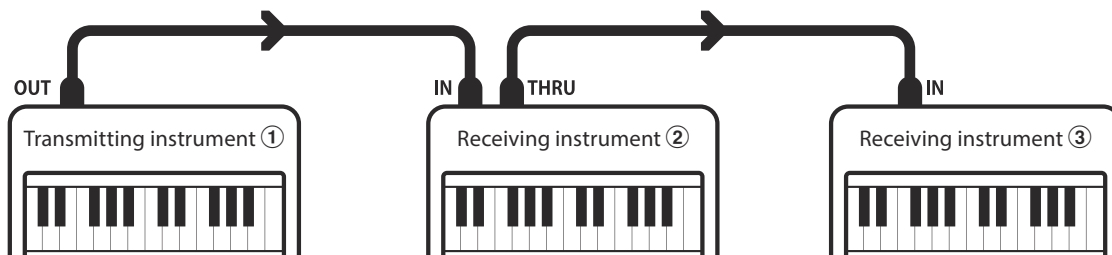

Transmitting instrument ① sends transmit channel and keyboard information to receiving instruments ②/③.

The information arrives at the receiving instruments ②/③.

Receiving instruments ②/③ will respond to MIDI data that is sent if their receive channel is the same as the transmit channel of the transmitting instrument ①. If the channels do not match, the receiving instruments ②/③ will not respond to any data that is sent.

For both receiving and transmitting, channels 1-16 can be used.

Recording/playing with a sequencer

When connected to a sequencer (or a computer running MIDI sequencing software), the NV10 hybrid digital piano can be used to record and playback multi-track songs, with separate sounds playing simultaneously on each channel.

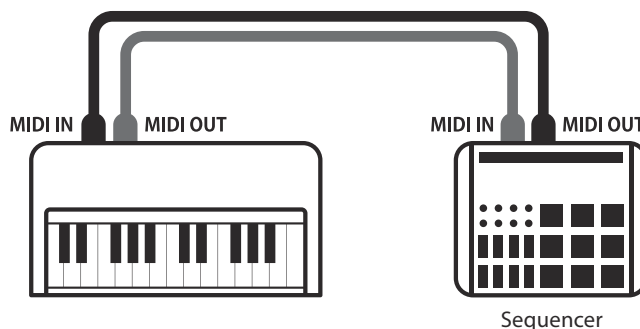

■ MIDI Functions

The NV10 hybrid digital piano supports the following MIDI functions:

Transmit/receive note information

Transmit/receive note information to/from a MIDI-connected musical instrument or device.

Transmit/receive channel settings

Specify transmit/receive channels within the range of 1 to 16.

Transmit/receive exclusive data

Transmit/receive front panel or menu function settings as exclusive data.

Multi-timbral mode setting

Receive multiple channel MIDI data from a MIDI-connected musical instrument or device.

Transmit/receive program change information

Transmit/receive program change data to/from a MIDI-connected musical instrument or device.

Transmit/receive pedal data

Transmit/receive sustain, sostenuto, and soft pedal data to/from a MIDI-connected musical instrument or device.

Receive volume data

Receive MIDI volume data sent from a MIDI-connected musical instrument or device.

* Please refer to the 'MIDI Implementation Chart' on page 173 for further information regarding the MIDI capabilities of the NV10 hybrid digital piano.

7 MIDI Channel

The MIDI Channel setting allows the transmit/receive channel to be specified. The selected channel will function as both the transmit and receive channel (separate transmit/receive channels cannot be specified).

■ Changing the MIDI Channel

Swipe left/right or tap the arrow buttons to change the MIDI Channel setting.

- * The MIDI Channel value can be adjusted within the range of 1~16.
- * Any changes made to the MIDI Channel setting will remain until the power is turned off.

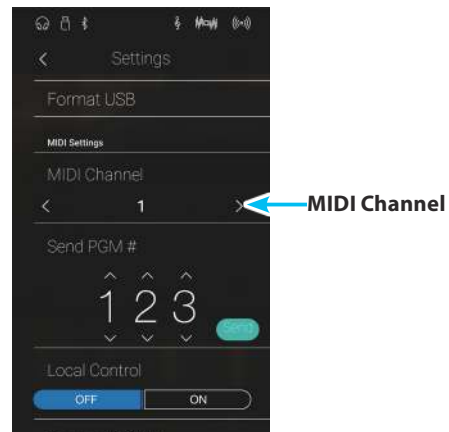

■ Omni mode

When the NV10 hybrid digital piano is turned on, the instrument is automatically set to 'omni mode on', allowing MIDI information to be received on all MIDI channels (1-16). When the MIDI Channel setting is used to specify a transmit/receive channel, the instrument will be set to 'omni mode off'.

■ Multi-timbral mode and Split/Dual modes

Using Split mode with Multi-timbral mode enabled

Notes played in the lower section of the keyboard will be transmitted on the channel that is 1 channel higher than the specified channel. For example, if the MIDI channel is set to 3, notes played in the lower section of the keyboard will be transmitted on channel 4.

Using Dual mode with Multi-timbral mode enabled

Notes played will be transmitted on two channels: the specified channel and the channel that is 1 channel higher.

For example, if the MIDI channel is set to 3, notes played on the keyboard will be transmitted on channels 3 and 4.

- * If the specified MIDI channel is 16, the lower section / layered part will be transmitted on channel 1.

8 Send Program Change Number

The Send Program Change Number function is used to send a Program Change Number (1-128) to the connected MIDI device.

■ Sending the Program Change Number

1. Swipe up/down or tap the arrow buttons above and below each digit to set the Program Change Number.

* The program change number can be set within the range of 1~128.

2. Tap the [Send] button to send the specified Program Change Number.

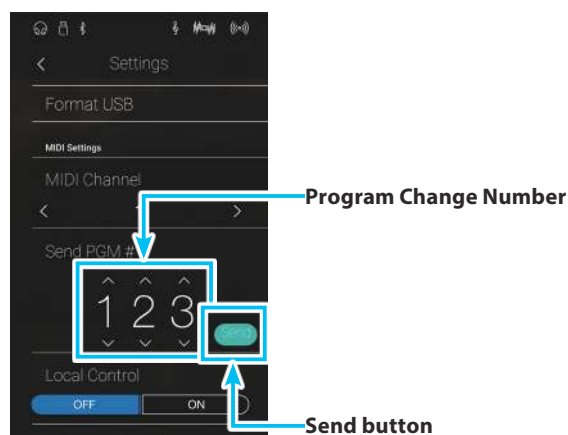

9 Local Control

The Local Control setting determines whether the instrument will play an internal sound when the keys are pressed. This setting may be useful when using the NV10 hybrid digital piano to control an external MIDI device that is connected to the instrument's amplifier/speakers.

■ Local Control setting

Local Control	Description
Off	The instrument will transmit information to an external MIDI device only.
On (default)	The instrument will play an internal sound and transmit information to an external MIDI device.

■ Changing the Local Control setting

Tap the [ON/OFF] buttons to turn Local Control on/off.

* Any changes made to the Local Control setting will remain until the power is turned off.

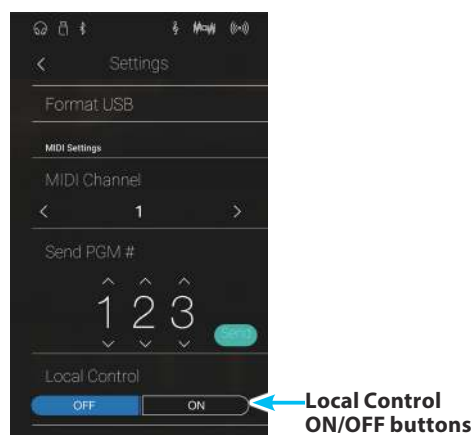

10 Transmit Program Change Numbers

The Transmit Program Change Numbers setting determines whether the NV10 hybrid digital piano will transmit program change information via MIDI when the instrument's panel buttons are pressed.

■ Transmit Program Change Numbers setting

Transmit PGM#	Multi-timbral setting	Effect of pressing panel buttons
On (default)	Off, On1	Sound mode selections will send PGM# shown in the left column*.
On	On2	Sound mode selections will send PGM# shown in the right column*.
Off	Off	Program Change information will not be transmitted via MIDI.

* Please refer to the 'Program Change Number List' on page 162.

■ Changing the Transmit Program Change Numbers setting

Tap the [ON/OFF] buttons to turn Transmit Program Change Numbers on/off.

* Any changes made to the Transmit Program Change Numbers setting will remain until the power is turned off.



Transmit Program Change Numbers ON/OFF buttons

■ Omni mode

- When using Dual or Split mode, On/Off information and sound type settings for are transmitted as exclusive data, however program change numbers will not be transmitted.
- Program change numbers will also be transmitted when Multi-timbral mode is set to On1 or On2.

11 Multi-timbral Mode

The Multi-timbral Mode setting determines whether or not the NV10 hybrid digital piano is able to receive MIDI information on more than one MIDI channel simultaneously. This allows the instrument to play back multi-track, multi-timbral performance data sent from an external MIDI device.

Multi-timbral Mode setting

Multi-timbral Mode	Selected sound
Off (default)	The sound shown in the left column is selected*.
On1	The sound shown in the left column is selected*.
On2	The sound shown in the right column is selected*.

* Please refer to the 'Program Change Number List' on page 162.

Changing the Multi-timbral Mode setting

Swipe left/right or tap the arrow buttons to change the Multi-timbral Mode setting.

* Any changes made to the Multi-timbral Mode setting will remain until the power is turned off.

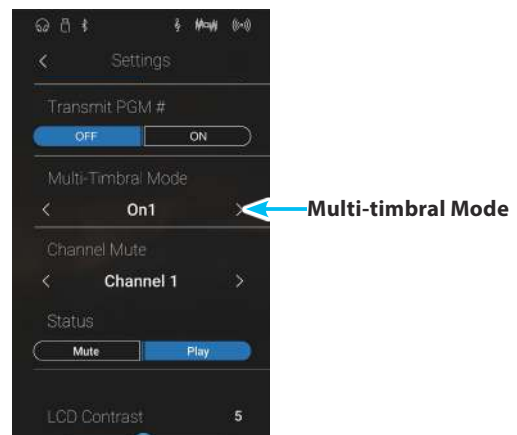

12 Channel Mute

The Channel Mute setting determines which MIDI channels (1~16) are activated to receive MIDI information when Multi-timbral mode is enabled.

Changing the Channel Mute setting

1. Swipe left/right or tap the arrow buttons to select the desired MIDI channel.

* The MIDI Channel value can be adjusted within the range of 1~16.

2. Tap the [Mute/Play] buttons to change the status of the selected MIDI channel.

* Any changes made to the Channel Mute setting will remain until the power is turned off.

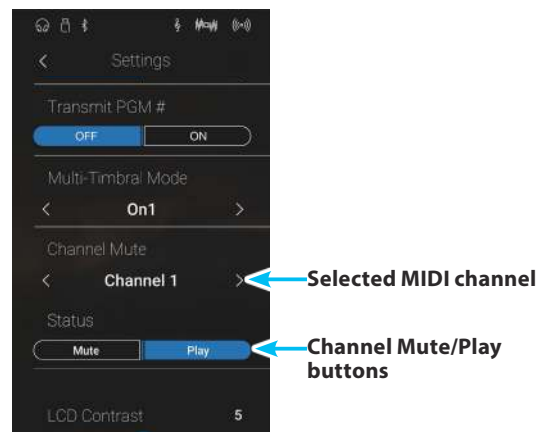

13 LCD Contrast

The LCD Contrast setting is used to adjust the contrast of the NV10 hybrid digital piano's touchscreen display. The contrast of the display becomes sharper as the value increases.

■ Adjusting the LCD Contrast setting

Long press and drag the slider to adjust the LCD Contrast setting.

- * The LCD Contrast setting can be adjusted within the range of 0~10.
- * Any changes made to the Bluetooth Audio setting will remain until the power is turned off.

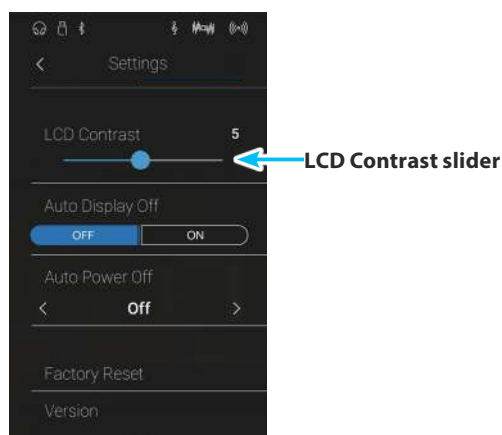

14 Auto Display Off

The Auto Display Off setting determines whether or not the NV10 hybrid digital piano's touchscreen display will turn off automatically after a period of inactivity. This setting may be desirable if the display becomes a distraction when playing in low-light environments.

■ Auto Display Off setting

Auto Display Off	Description
Off (default)	The instrument's LCD display will remain turned on at all times.
On	The instrument's LCD display will turn off automatically after a period of inactivity.

■ Changing the Auto Display Off setting

Tap the [ON/OFF] buttons to turn Auto Display Off on/off.

- * When set to 'On', the LCD display will turn off after a period of inactivity. To turn the display on again, simply tap anywhere on the display.
- * Any changes made to the Auto Display Off setting will remain until the power is turned off.

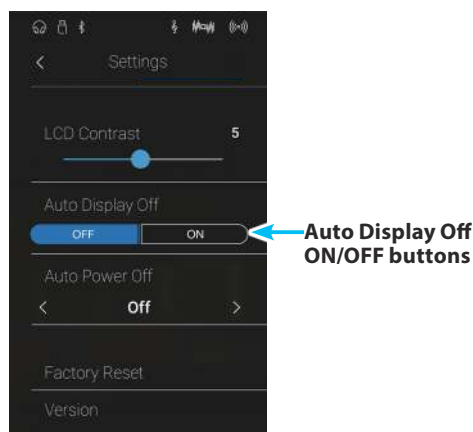

15 Auto Power Off

The Auto Power Off setting can be used to automatically turn off the instrument after a specified period of inactivity. This function may be enabled by default, depending on the market location.

* This setting will be stored automatically, and recalled every time the instrument is turned on.

■ Auto Power Off settings

Auto Power Off	Description
Off	The Auto Power Off function is disabled.
15 min.	The instrument will turn off automatically after 15 minutes of inactivity.
60 min.	The instrument will turn off automatically after 60 minutes of inactivity.
120 min.	The instrument will turn off automatically after 120 minutes of inactivity.

■ Changing the Auto Power Off setting

Swipe left/right or tap the arrow buttons to change the Auto Power Off setting.

* The Auto Power Off setting will be stored automatically, and recalled every time the instrument is turned on.

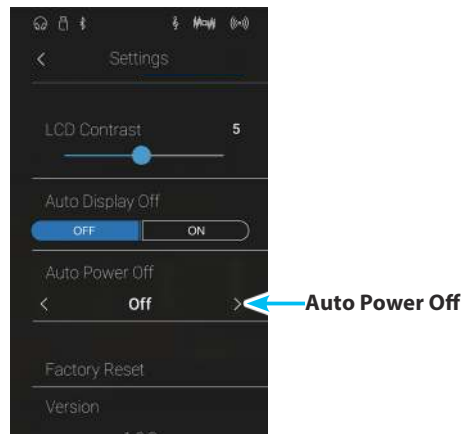

16 Factory Reset

The Factory Reset function clears any user adjustments stored to sound memories, restoring the NV10 hybrid digital piano to its factory default settings.

* This function will not clear Favorites memories or recorder songs stored in internal memory.

Restoring Factory settings

1. Tap [Factory Reset].

A confirmation box will be shown.

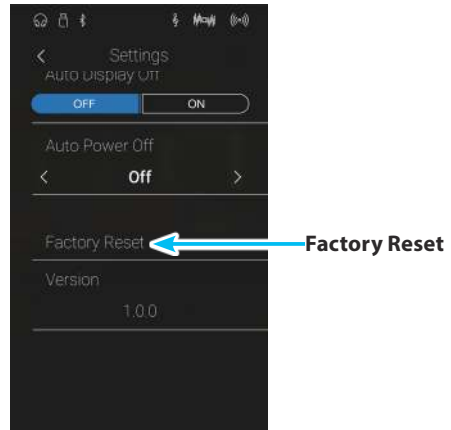

2. Tap the [Yes] button to confirm the Factory Reset operation, or the [No] button to cancel.

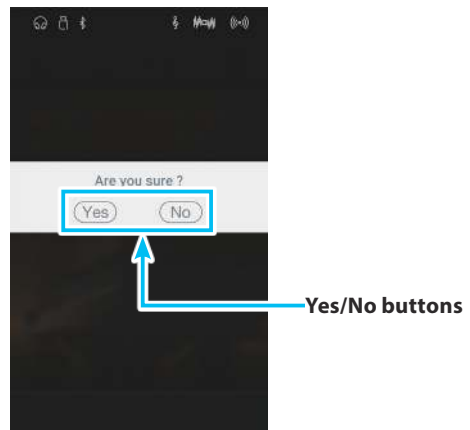

Assembly Instructions



Please read these assembly instructions thoroughly before attempting to assemble the NV10 hybrid digital piano. Please ensure that three or more people work on assembling the NV10 hybrid digital piano, especially when lifting the main body of the instrument onto the stand.

Included parts

Before attempting to assemble the NV10 hybrid digital piano, ensure that all parts below are included. A Phillips-head screwdriver (not included) will also be required in order to assemble the instrument. Please do not remove the main unit from the box before step 3.

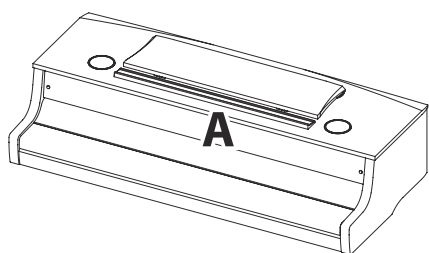

Main body

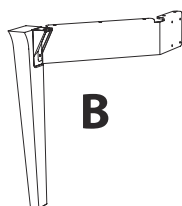

Leg 1 (left)

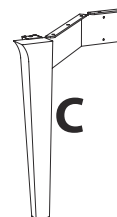

Leg 2 (right)

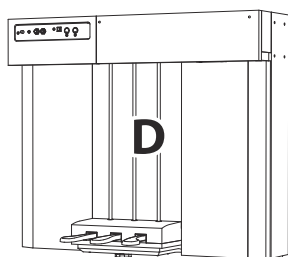

Pedal base

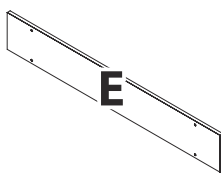

Stand back board



Power cable

Screw set

a Screw (6 x 35 mm) x 12

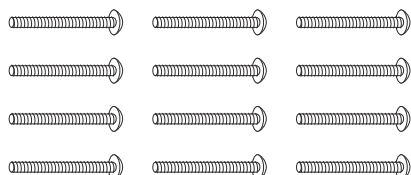

b Screw (4 x 30 mm) x 8

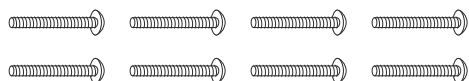

c Screw (4 x 20 mm) x 5



Headphone hook set

Headphone hook

Mounting screws (4 x 14 mm) x 2



Assembly Instructions

1. Attaching the legs to the pedal base

- 1 Place the pedal base (D) on a flat floor. Check that there are no musical scores or parts on the floor, and ensure that the pedal support bolt is attached.
- 2 Loosely attach the left leg (B) to the pedal base (D) using 4 screws ⑥.
- 3 Press the metal fitting plate of the left leg firmly against the pedal base, and ensure that the base makes firm contact with the floor, then tighten the four screws.
- 4 Attach the right leg (C) to the pedal base using the 4 remaining screws ⑥, in the same way as step 1-2.
- 5 Ensure that the assembled pedal base and legs are absolutely stable and do not rattle when pushed. If the stand is not completely steady, loosen the screws attached in the previous steps, gently reposition the parts, and then retighten the screws.

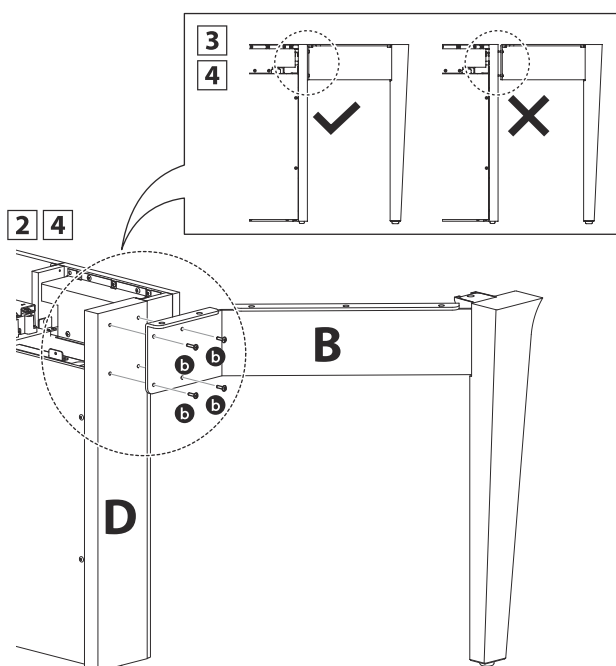
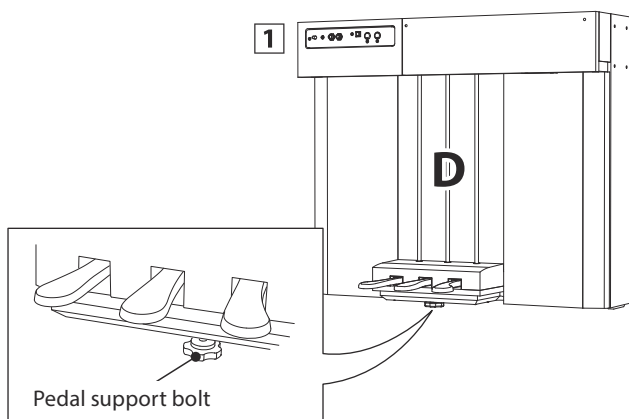

2. Removing the main unit from the box

- 1 Check that the main unit box is facing upward, then open the upper side of the box.

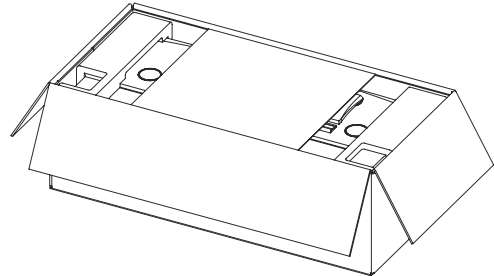

- 2 Cut the four sides of the box, and open them out fully.

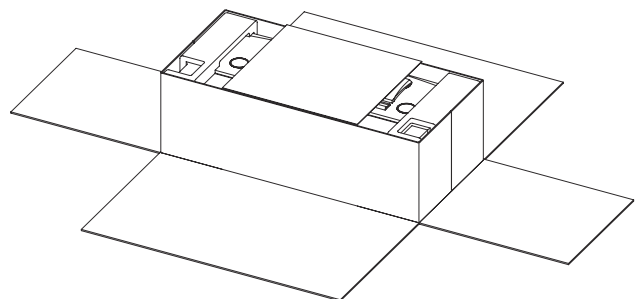

Be careful not to injure hands or fingers when cutting the box.

- 3 Remove the corrugated boards (side, upper side), polystyrene foam (upper side), and any remaining packaging material, to allow the main body (A) to be lifted.

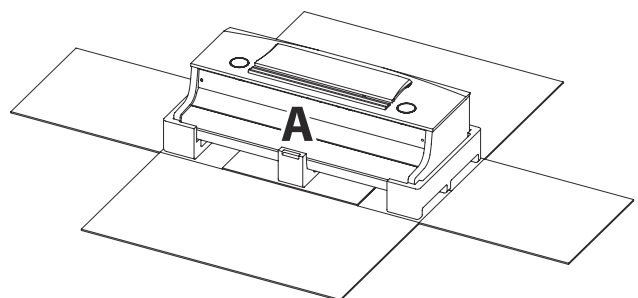

3. Mounting the main body onto the stand



Ensure that three or more people undertake the following step of the assembly process.

- 1 Remove the main body from the box, lifting the unit sufficiently onto the back of the stand. Adjust the positioning to ensure that the guides on the main body fit inside the side plates of the pedal base.
- 2 Gently slide the main body forward so that when viewed from directly above, the front of the main body is aligned with the centre of the plastic parts of the stand's legs. At this point, the main body will be tilted back. Proceed to the next step promptly.
- 3 Lift the main body and gently position the unit so that its screw holes (on the underside) correctly align with the metal fittings of the stand's legs.

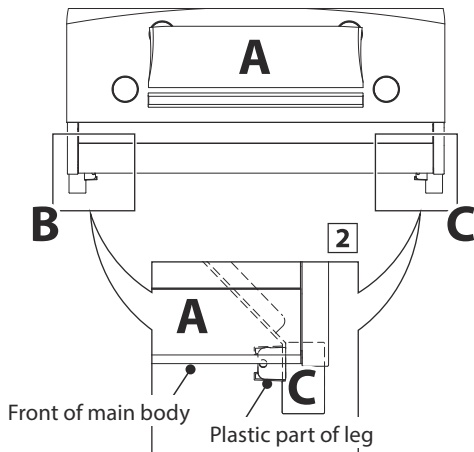
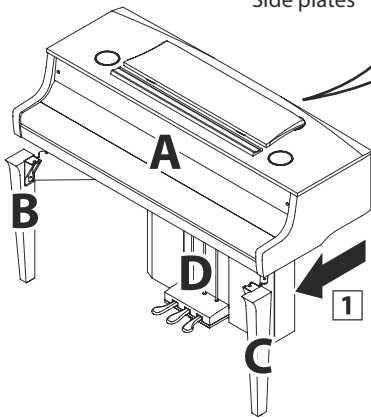
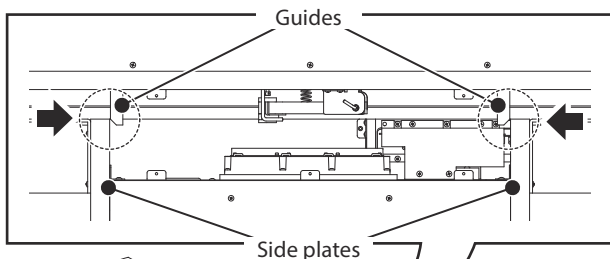

When lifting and positioning the main body, do not hold the gray shaded areas.

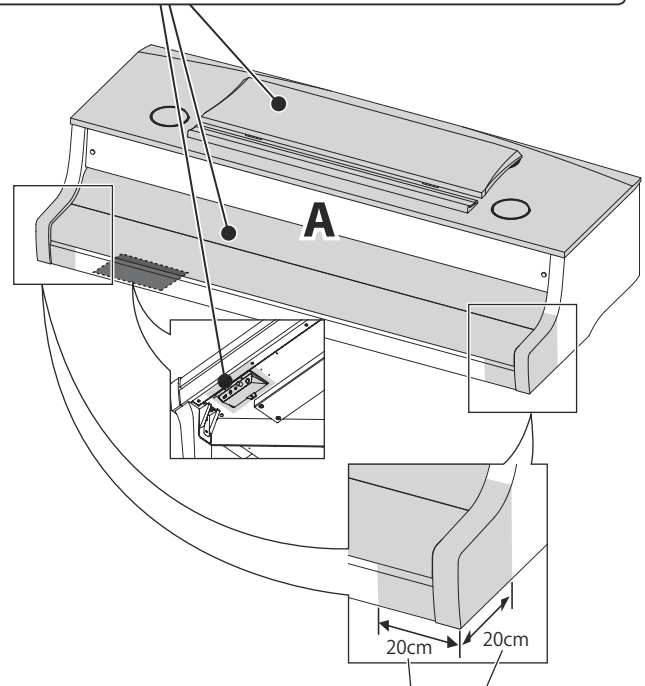

Do not hold the main body from the front of the unit, in order to prevent catching/trapping hands or fingers on the stand's legs.

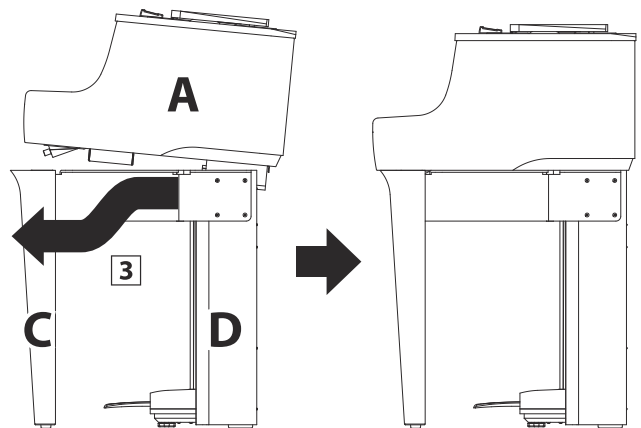

When lifting the main body onto the stand, be careful not to catch/trap hands or fingers.

Assembly Instructions

4. Fastening the main body to the stand

- 1 Loosely attach the main body to the stand using 2 screws **a** at the front of the instrument (through the legs), and 10 screws **a** towards the back of the instrument.
- 2 Adjust the positioning of the main body to ensure that when viewed from the front, the body and legs are correctly aligned.
- 3 When the main body and legs are correctly aligned, tighten all 12 screws firmly.
- 4 Ensure that the assembled instrument is absolutely stable and does not rattle when pushed. If the stand is not completely steady, loosen the screws attached in steps 1-2-1-4, gently reposition the parts, and then retighten the screws.

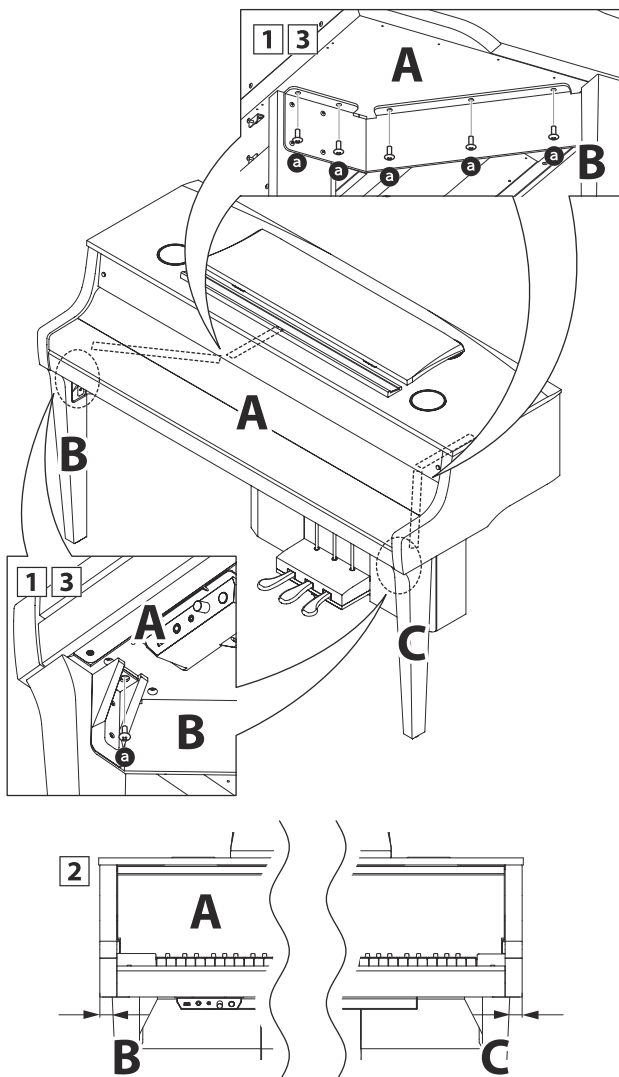

5. Connecting the cords

- 1 Carefully connect the two cords to their respective plugs.
- 2 Ensure that the cords are connected securely, and that there are no gaps between the plugs.

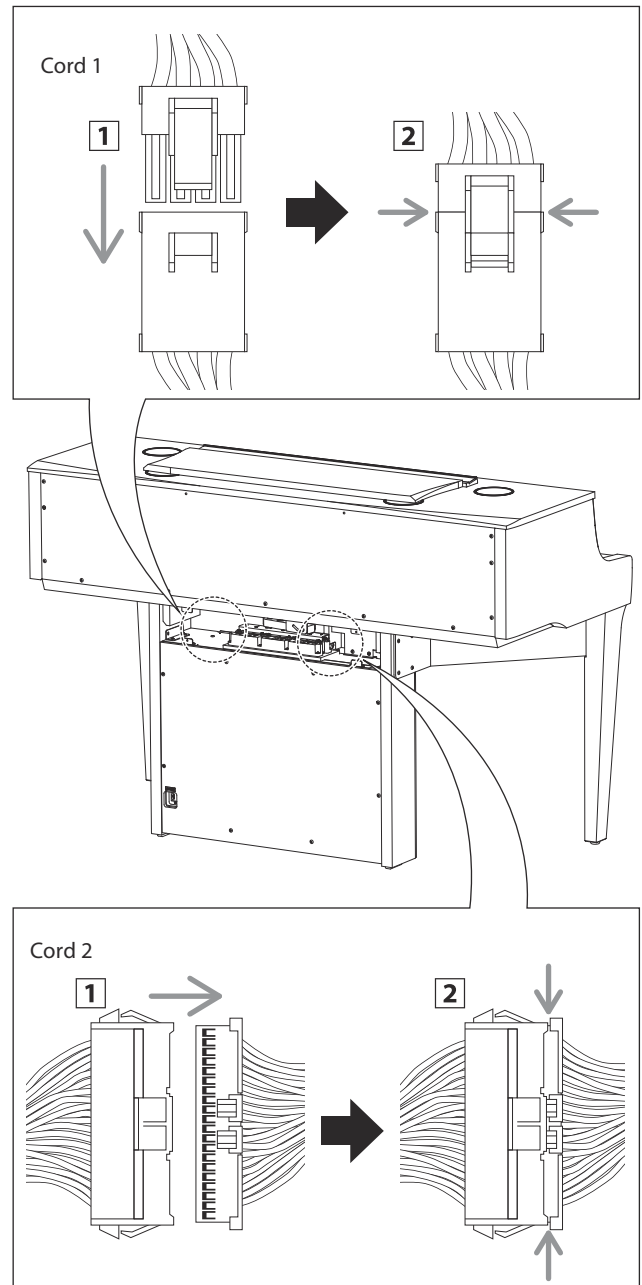

! Ensure that the two cords are connected securely to ensure that the instrument's keyboard and pedals work correctly.

! Tighten all screws securely to ensure that the main body is firmly attached to the stand.

6. Attaching the stand back board

Attach the stand back board (E) to the pedal base using 5 screws (C).

Ensure that cords 1 and 2 do not get trapped between the stand back board and the pedal base's metal fittings.

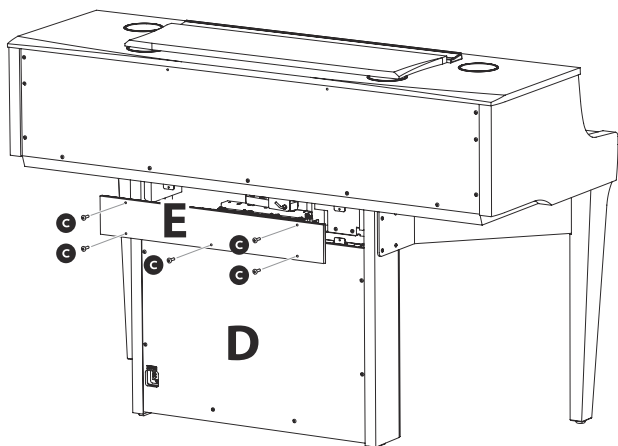

7. Connect the power cable to the instrument

Connect the included power cable to the AC IN terminal located on the back side of the pedal base, in the bottom left corner.

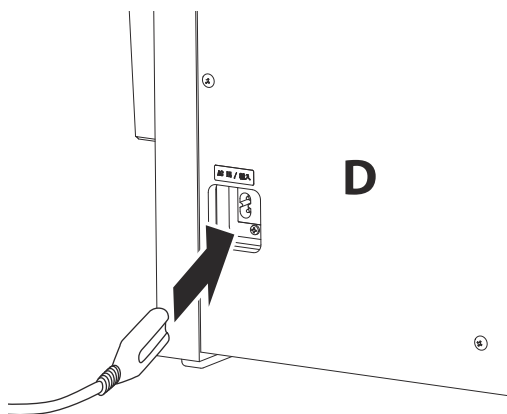

8. Attaching the headphone hook (optional)

A headphone hook is included with the NV10 hybrid digital piano and can be used to hang headphones when not in use.

If desired, attach the headphone hook to the underside of the main body using the two tapping screws provided.

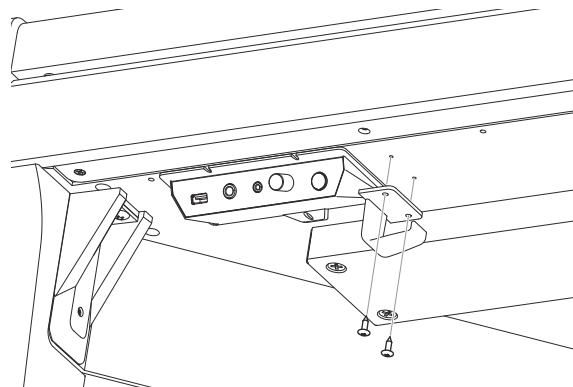

9. Adjusting the pedal support bolt

Turn the pedal support bolt anti-clockwise, extending the bolt until it makes contact with the floor and supports the pedals firmly.

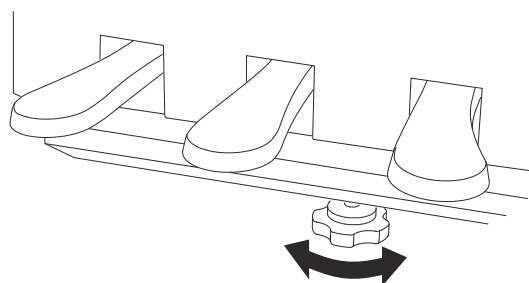

When moving the instrument, always retract (raise) the pedal support bolt, then readjust when the instrument is in its new position. Also, ensure that the instrument is moved by lifting and not dragged or pushed.

Connecting to Other Devices

The NV10 hybrid digital piano features a variety of jacks that allow the instrument to be connected to MIDI devices, computers, speakers, and mixers. It is also possible to connect external audio sources, such as an MP3 player, tablet, or a secondary keyboard, to the instrument's amplifier and speaker system. The illustration below provides a visual overview of the connectors and their typical applications.

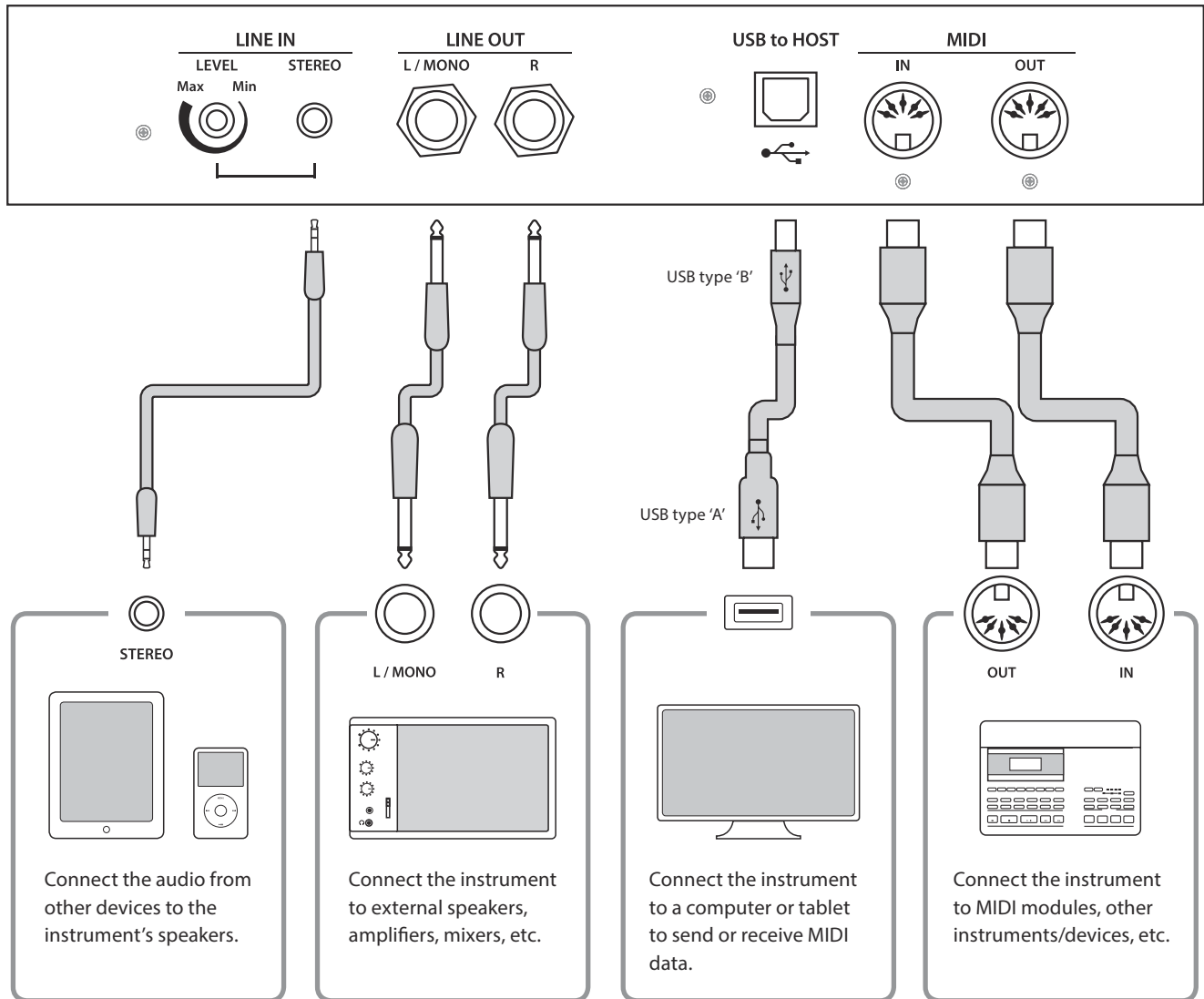

Before connecting the NV10 hybrid digital piano to other devices, ensure that the power to both the instrument and the other device is turned off. If connections are established while the power is turned on, extraneous noise that can damage the NV10 hybrid digital piano may activate the instrument's amplifier protection circuit, preventing any sound from being produced. If this occurs, turn the power off and then on again to reset the amplifier protection circuit.

Do not connect the LINE IN and LINE OUT jacks of the NV10 hybrid digital piano together with the same cable. An audio loop (oscillation sound) will occur, resulting in damage to the unit.

Jack Panel

■ LINE IN STEREO jack (1/8" phone jack)

This jack is used to connect the 1/8" stereo outputs from smart phones, tablets, computers, or other electronic audio equipment to the NV10 hybrid digital piano's amplifier and speakers. The input level can be adjusted using the LEVEL knob, or by adjusting the volume of the connected device.

When using the USB audio recorder function, this LINE in audio will also be mixed with the instrument's internal sound and recorded to the MP3/WAV file.

* The 'Line In Level' setting can also be used to adjust the level of the LINE IN signal. Please refer to page 128 for more information.

■ USB to Host port ('B' type)

This USB port is used to connect the NV10 hybrid digital piano to a computer using an inexpensive USB cable. When connected, the instrument can be used as a standard MIDI device, allowing it to send and receive MIDI data. Connect a 'B' type USB connector to the instrument, and an 'A' type USB connector to the computer.

* Please refer to page 156 for more information about USB MIDI.

With additional conversion adaptors, this port may also be used to connect the NV10 hybrid digital piano to tablets and other mobile devices.

■ LINE OUT jacks (1/4" phone jack)

These jacks are used to connect the stereo output of the NV10 hybrid digital piano's sound to external speakers, amplifiers, mixers, recording devices, and similar equipment.

To output a mono signal, connect a single cable to the L/MONO jack.

The LINE OUT level can be adjusted using the MASTER VOLUME knob.

■ MIDI IN/OUT jacks

These jacks are used to connect the NV10 hybrid digital piano to external MIDI devices, or to a computer (using a USB-MIDI interface) as an alternative to the 'USB to Host' port.

* Please refer to page 140 for more information about MIDI.

Headphone Panel

■ PHONES jacks (1/4" & 1/8" phone jacks)

These jacks are used to connect stereo headphones to the NV10 hybrid digital piano. Two pairs of headphones can be connected and used simultaneously. When a pair of headphones is connected, sound will not be produced by the speakers.

■ USB device information

- The 'USB to Device' functionality of the NV10 hybrid digital piano conforms to USB2.0 Hi-Speed standards. Older USB devices can still be used, however data transfer speed will be limited to the maximum transfer speed of the device.
- The 'USB to Device' port is intended for connecting USB memory devices, however USB floppy drive devices can also be used to save recorder songs stored in internal memory, or play SMF song files.

■ USB to Device port ('A' type)

This USB port is used to connect a USB memory device to the NV10 hybrid digital piano. This allows MP3/WAV audio files, and SMF song files to be played directly. It is also possible to record performances to MP3/WAV audio files, and save recorder songs stored in internal memory for posterity.

- It may be necessary to format the USB memory device before it can be used with the NV10 hybrid digital piano. If so, please refer to the USB Format function instructions on page 139. Formatting the device will erase all data.
- Avoid removing the USB memory device while data is being loaded or saved, files are being renamed or deleted, or the device is being formatted.
- Other USB devices, such as computer mice, keyboards, or battery chargers etc. cannot be used with this instrument.

USB MIDI (USB to Host connector)

The NV10 hybrid digital piano features a 'USB to Host' type connector, allowing the instrument to be connected to a computer using an inexpensive USB cable and utilised as a MIDI device. Depending on the type of computer and operating system installed, additional driver software may be required for USB MIDI communication to function correctly.

■ USB MIDI driver

Operating System	USB MIDI Driver Support
Windows ME Windows XP (no SP, SP1, SP2, SP3) Windows XP 64-bit Windows Vista (SP1, SP2) Windows Vista 64-bit (SP1, SP2) Windows 7 (no SP, SP1) Windows 7 64-bit Windows 8 / 8.1 Windows 8 / 8.1 64-bit Windows 10 Windows 10 64-bit	<p>Additional USB MIDI driver software NOT required.</p> <p>The standard (built-in) Windows USB MIDI driver will be installed automatically when the instrument is connected to the computer.</p> <p>* After driver installation, ensure that the 'USB Audio Device' (Windows ME/Windows XP) or 'USB-MIDI' (Windows Vista/Windows 7/Windows 8) device is correctly selected in the application software.</p>
Windows 98 se Windows 2000 Windows Vista (no SP)	<p>Additional USB MIDI driver software required.</p> <p>Please download the USB MIDI driver from the Kawai Japan website: → http://www.kawai-global.com/support/downloads/</p> <p>* After driver installation, ensure that the 'KAWAI USB MIDI' device is correctly selected in the application software.</p>
Windows Vista 64-bit (no SP)	<p>USB MIDI is not supported.</p> <p>Please upgrade to service pack 1 or service pack 2.</p>
Mac OS X	<p>Additional USB MIDI driver software NOT required.</p> <p>The standard (built-in) Mac OS X USB MIDI driver will be installed automatically when the instrument is connected to the computer.</p>
Mac OS 9	<p>USB MIDI is not supported.</p> <p>Please use the standard MIDI IN/OUT connectors.</p>

■ USB MIDI information

- If the instrument's MIDI IN/OUT jacks and USB MIDI port are both connected simultaneously, the USB MIDI port will be given priority.
- Ensure that the instrument is turned OFF before attempting to connect the USB MIDI cable.
- When connecting the instrument to a computer using the USB MIDI port, there may be a short delay before communications begin.
- If the instrument is connected to a computer via a USB hub and USB MIDI communication becomes unreliable/unstable, please connect the USB MIDI cable directly to the one of the computer's USB ports.
- Disconnecting the USB MIDI cable suddenly, or turning the instrument on/off while using USB MIDI may cause computer instability in the following situations:
 - while installing the USB MIDI driver
 - while starting up the computer
 - while MIDI applications are performing tasks
 - while the computer is in energy saver mode
- If there are any further problems experienced with USB MIDI communication while the instrument is connected, please double-check all connections and relevant MIDI settings in the computer's operating system.

* 'MIDI' is a registered trademark of the Association of Manufacturers of Electronic Instruments (AMEI).

* 'Windows' is registered trademark of Microsoft Corporation.

* 'Macintosh' is registered trademark of Apple Computer, Inc.

* Other company names and product names mentioned referenced herein may be registered trademarks or trademarks of respective owners.

Troubleshooting

The tables below summarise issues that may be experienced with the NV10 hybrid digital piano, explaining the typical cause(s), and recommended solution(s).

■ Power

Problème	Cause possible et solution	Page
<i>The instrument does not turn on.</i>	Check that the power cable is firmly attached to the instrument, and connected to an AC outlet.	p. 14
<i>The instrument turns itself off after a period of inactivity.</i>	Check that the 'Auto Power Off' function is not enabled.	p. 147

■ Sound

Issue	Possible Cause and Solution	Page no.
<i>The instrument is turned on, however no sound is produced when the keys are pressed.</i>	Check that the MASTER VOLUME knob is not set to the lowest position.	p. 16
	Check that a pair of headphones (or headphone adaptor plug) are not connected to the PHONES jacks.	p. 16
	Check that the 'Local Control' setting in the MIDI Settings menu is set to On.	p. 143
<i>The sound distorts when playing at very loud volume levels.</i>	Check that the MASTER VOLUME knob is set to an appropriate level, reducing the volume if excessive distortion is heard. If connecting the instrument to an amplifier/mixer using the Line Out jacks, reduce the value of the 'Line Out Volume' setting in the Basic Settings menu.	p. 16
<i>Strange sounds or noises are heard when playing with piano sounds.</i>	The NV10 hybrid digital piano attempts to reproduce the rich variety of tones created by an acoustic grand piano as accurately as possible. This includes various resonances, noises, and other subtle characteristics that contribute to the overall piano playing experience. While these additional tones are intended to enhance the realism of the instrument, it is possible to reduce their prominence, or disable the effects altogether using the settings in the Virtual Technician menu.	
	The noise occurs when the damper pedal is depressed and released. ➔ Damper Noise	p. 106
	The noise occurs after a key is released. ➔ Fall-back Noise, Key-off Effect	p. 110 p. 111
	The sound has a metallic characteristic. ➔ Key-off Effect, Undamped Resonance, String Resonance	p. 107 p. 108 p. 110
	The sound is muffled or too bright. ➔ Topboard, Voicing	p. 104 p. 113
	A particular key's level/volume is higher than other keys. ➔ User Key Volume	p. 121
	A particular key's pitch is heard as incorrect. ➔ Temperament, User Temperament, User Stretch Tuning	p. 116 p. 117 p. 118
<i>The top 18 notes of the keyboard sustain for longer than neighbouring notes, even when the damper pedal is not pressed.</i>	This is the correct behaviour, and intended to reproduce the undamped notes (typically the top two octaves) of an acoustic grand piano.	–
<i>The volume of the device connected to the Line In jacks is too low/too high (distorted).</i>	Check the position of the Line In LEVEL knob (located on the jack panel), and adjust as necessary.	p. 155

Troubleshooting

■ Pedals

Issue	Possible Cause and Solution	Page no.
<i>The pedals are unreliable or do not function at all.</i>	Check that the pedal cable is firmly connected to the instrument.	p. 152
<i>When depressing a pedal, the pedal board flexes and is not firm.</i>	Check that the pedal support bolt is fully extended.	p. 17 p. 153

■ Headphones

Issue	Possible Cause and Solution	Page no.
<i>The headphone volume is too low.</i>	If the 'Nominal Impedance' specification of the headphones is less than 100 Ω (ohms), set the 'Phones Volume' setting in the Phones Settings menu to High.	p. 132
<i>The headphone output sounds strange.</i>	Check that the 'SHS Mode' and 'Phones Type' settings are set to 'Normal'.	p. 130 p. 131

■ USB (memory device)

Issue	Possible Cause and Solution	Page no.
<i>A USB memory device is not detected, cannot be saved to, or does not appear to function when connected to the 'USB to Device' port.</i>	Check that the USB memory device is formatted to use the FAT/FAT32 filesystem, and not set to 'Write Protect' mode.	p. 155
	Disconnect the USB memory device, turn the instrument off then on, then reconnect the USB device. If the USB device still does not function, it may be damaged or incompatible. Please try using a different USB device.	–
<i>The instrument pauses briefly when connecting a USB memory device.</i>	This is recognised behaviour when using large capacity (e.g. 8GB+) USB memory devices.	–

■ USB MIDI, MIDI, Bluetooth® MIDI

Issue	Possible Cause and Solution	Page no.
<i>The instrument is connected to the computer using a USB cable, however the software does not respond to key presses.</i>	Check that a USB MIDI driver is installed on the computer.	p. 156
	Check that 'USB Audio Device' or 'KAWAI USB MIDI' is selected in the software's input/output device settings.	p. 156
	Check that the instrument is not connected to a smart device using Bluetooth MIDI.	p. 134
<i>The instrument cannot connect to the smart device/app via Bluetooth.</i>	Check that the instrument's Bluetooth MIDI/Audio function is turned On.	p. 134
	Ensure that the mobile device's Bluetooth function is turned On.	–
	Ensure that the instrument isn't already connected to another Bluetooth device.	–
	Try deleting the instrument's Bluetooth connection using the mobile device's 'Forget Device' function.	–
	Try turning the instrument Off and then On, and/or restarting the mobile device.	–

■ MP3/WAV/SMF files

Issue	Possible Cause and Solution	Page no.
<p><i>No sound can be heard when playing an MP3 or WAV audio file stored on a USB memory device.</i></p>	<p>Check that the audio player volume is not set to 0.</p>	<p>p. 79</p>
	<p>Check that the format of the audio file is supported and listed in the 'USB Memory Player supported formats' table.</p>	<p>p. 75</p>
<p><i>An MP3/WAV audio file stored on a USB memory device sounds strange, or does not play back correctly.</i></p>	<p>Check that the format of the audio file is supported and listed in the 'USB Memory Player supported formats' table.</p>	<p>p. 75</p>
	<p>The file transfer speed of the USB memory device may be too slow to play the audio file. Please try using a different USB memory device, ensuring that it conforms to USB2.0 Hi-Speed standards.</p>	<p>p. 155</p>
<p><i>When recording MP3/WAV audio files, the volume is too low/too high (distorted).</i></p>	<p>Check the gain setting before recording the audio, and if necessary adjust to increase/decrease the recording level.</p>	<p>p. 49</p>
<p><i>An SMF MIDI file stored on a USB memory device sounds strange when played back.</i></p>	<p>The NV10 hybrid digital piano does not contain the full General MIDI sound bank selection. Consequently, some SMF song files may not be reproduced entirely accurately when played through the instrument.</p>	<p>p. 49</p>

Demo Song List

Sound Name	Song Title	Composer
PIANO1		
SK Concert Grand	Scherzo No.2	Chopin
EX Concert Grand	La Campanella	Liszt
SK-5 Grand	Lieder Ohne Worte No.18 "Duetto"	Mendelssohn
Jazz Clean	Original	Kawai
Warm Grand	Sonata No.30 Op.109	Beethoven
Warm Grand 2	La Fille aux Cheveux de lin	Debussy
Standard Grand	Petit chien	Chopin
PIANO2		
Pop Grand	Original	Kawai
Pop Piano	Original	Kawai
New Age Grand	Original	Kawai
Upright Piano	Nocturne No. 20 Op. posth.	Chopin
Modern Piano	Original	Kawai
ELECTRIC PIANO		
Classic E.Piano	Original	Kawai
Modern E.P.	Original	Kawai
Modern E.P. 2	Original	Kawai
ORGAN		
Jazz Organ	Original	Kawai
Blues Organ	Original	Kawai
Drawbar Organ	Original	Kawai
Church Organ	Chorale Prelude "Wachet auf, ruft uns die Stimme."	Bach
Diapason	Wohl mir, daß ich Jesum have	Bach
Full Ensemble	Original	Kawai
HARPSI & MALLETS		
Harpsichord	French Suite No.6	Bach
Harpsichord Oct.	Prelude in Ab	Bach
Vibraphone	Original	Kawai
Clavi	Original	Kawai
STRINGS		
Slow Strings	Original	Kawai
String Pad	Original	Kawai
String Ensemble	Le quattro stagioni La primavera	Vivaldi
VOCAL & PAD		
Choir	Londonderry Air	Irish folk song
Choir 2	Original	Kawai
Jazz Ensemble	Original	Kawai
New Age Pad	Original	Kawai
Atmosphere	Original	Kawai
BASS & GUITAR		
Wood Bass	Original	Kawai
Finger Bass	Original	Kawai
Fretless Bass	Original	Kawai
W. Bass & Ride	Original	Kawai
Ballad Guitar	Original	Kawai
Pick Nylon Gt.	Original	Kawai

Sound List (Sound mode)

Piano 1

SK ConcertGrand

EX ConcertGrand

SK-5 GrandPiano

Jazz Clean

Jazz Old School

Warm Grand

Warm Grand 2

Standard Grand

Piano 2

Pop Grand

Pop Grand 2

Pop Piano

New Age Grand

Upright Piano

Modern Piano

Boogie Piano

Honky Tonk

Electric Piano

Classic Electric Piano

60's Electric Piano

Modern Electric Piano

Classic Electric Piano 2

Classic Electric Piano 3

Crystal Electric Piano

Modern Electric Piano 2

Modern Electric Piano 3

Organ

Jazz Organ

Blues Organ

Ballad Organ

Gospel Organ

Drawbar Organ

Drawbar Organ 2

Drawbar Organ 3

Drawbar Organ 4

Church Organ

Diapason

Full Ensemble

Diapason Oct.

Chiffy Tibia

Principal Oct.

Principal Choir

Baroque

Soft Diapasn

Soft Strings

Mellow Flutes

Medium Ensemble

Loud Ensembe

Bright Ensemble

Full Organ

Reed Ensemble

Harpsi & Mallets

Harpsichord

Harpsichord Oct

Vibraphone

Clavi

Marimba

Celesta

Harpsichord 2

Bell Split

Strings

Slow Strings

String Pad

Warm Strings

String Ensemble

Soft Orchestra

Chamber Strings

Harp

Pizzicato Str.

Vocal & Pad

Choir

Pop Ooh

Pop Aah

Choir 2

Jazz Ensemble

Pop Ensemble

Slow Choir

Breathy Choir

New Age Pad

Atmosphere

Itopia

Brightness

New Age Pad 2

Brass Pad

Bowed Pad

Bright Warm Pad

Bass & Guitar

Wood Bass

Finger Bass

Fretless Bass

W.Bass & Ride

E.Bass & Ride

Ballad Guitar

Pick Nylon Gt.

Finger Nylon Gt

Program Change Number List

Sound Name	Multi-timbral mode = off/on1		Multi-timbral mode = on2	
	Program Number	Program Number	Bank	
			MSB	LSB
Piano 1				
SK ConcertGrand	1	1	121	0
EX ConcertGrand	2	1	95	27
SK-5 GrandPiano	3	1	95	30
Jazz Clean	4	1	121	1
Jazz Old School	5	1	95	32
Warm Grand	6	1	121	2
Warm Grand 2	7	1	95	29
Standard Grand	8	1	95	16
Piano 2				
Pop Grand	9	1	95	28
Pop Grand 2	10	1	95	31
Pop Piano	11	2	95	10
New Age Grand	12	1	95	17
Upright Piano	13	1	95	25
Modern Piano	14	2	121	0
Boogie Piano	15	1	95	33
Honky Tonk	16	4	121	0
Electric Piano				
Classic Electric Piano	17	5	121	0
60's Electric Piano	18	5	121	3
Modern Electric Piano	19	6	121	0
Classic Electric Piano 2	20	5	121	1
Classic Electric Piano 3	21	5	95	1
Crystal Electric Piano	22	6	95	1
Modern Electric Piano 2	23	6	121	1
Modern Electric Piano 3	24	6	121	2
Organ				
Jazz Organ	25	18	121	0
Blues Organ	26	17	121	0
Ballad Organ	27	17	95	5
Gospel Organ	28	17	95	3
Drawbar Organ	29	17	95	1
Drawbar Organ 2	30	17	95	2
Drawbar Organ 3	31	18	121	2
Drawbar Organ 4	32	17	121	3
Church Organ	33	20	121	0
Diapason	34	20	95	7
Full Ensemble	35	21	95	1
Diapason Oct.	36	20	95	6
Chiffy Tibia	37	20	95	17
Principal Oct.	38	20	95	24
Principal Choir	39	20	95	23
Baroque	40	20	95	19

Sound Name	Multi-timbral mode = off/on1		Multi-timbral mode = on2	
	Program Number	Program Number	Bank	
			MSB	LSB
Soft Diapasn	41	20	95	45
Soft Strings	42	20	95	41
Mellow Flutes	43	20	95	48
Medium Ensemble	44	20	95	42
Loud Ensembe	45	20	95	43
Bright Ensemble	46	20	95	47
Full Organ	47	20	95	44
Reed Ensemble	48	20	95	46
Harpsi & Mallets				
Harpsichord	49	7	121	0
Harpsichord Oct	50	7	121	1
Vibraphone	51	12	121	0
Clavi	52	8	121	0
Marimba	53	13	121	0
Celesta	54	9	95	1
Harpsichord 2	55	7	121	3
Bell Split	56	15	95	5
Strings				
Slow Strings	57	45	95	1
String Pad	58	49	95	8
Warm Strings	59	49	95	1
String Ensemble	60	49	121	0
Soft Orchestra	61	50	95	1
Chamber Strings	62	49	95	14
Harp	63	47	121	0
Pizzicato Str.	64	46	121	0
Vocal & Pad				
Choir	65	53	121	0
Pop Ooh	66	54	95	39
Pop Aah	67	54	95	40
Choir 2	68	54	95	53
Jazz Ensemble	69	54	95	2
Pop Ensemble	70	54	95	7
Slow Choir	71	53	95	2
Breathy Choir	72	53	95	1
New Age Pad	73	89	121	0
Atmosphere	74	100	121	0
Itopia	75	92	121	1
Brightness	76	101	95	1
New Age Pad 2	77	89	95	2
Brass Pad	78	62	95	2
Bowed Pad	79	93	121	0
Bright Warm Pad	80	90	95	1

Program Change Number List

Sound Name	Multi-timbral mode = off/on1		Multi-timbral mode = on2	
	Program Number	Program Number	Bank	
			MSB	LSB
Bass & Guitar				
Wood Bass	81	33	121	0
Finger Bass	82	34	121	0
Fretless Bass	83	36	121	0
W.Bass & Ride	84	33	95	1
E.Bass & Ride	85	34	95	2
Ballad Guitar	86	26	95	6
Pick Nylon Gt.	87	25	95	3
Finger Nylon Gt	88	25	95	4
MIDI Tones				
Rock Piano	-	2	121	1
Electric Grand	-	3	121	0
Electric Grand2	-	3	121	1
Wide Honky Tonk	-	4	121	1
Classic E.P. 4	-	5	121	2
Legend E.P.	-	6	121	3
Phase E.P.	-	6	121	4
WideHarpichord	-	7	121	2
Synth Clavi	-	8	121	1
Celesta	-	9	121	0
Glockenspiel	-	10	121	0
Music Box	-	11	121	0
Wide Vibraphone	-	12	121	1
Wide Marimba	-	13	121	1
Xylophone	-	14	121	0
Tubular Bells	-	15	121	0
Church Bells	-	15	121	1
Carillon	-	15	121	2
Dulcimer	-	16	121	0
Drawbar Organ 5	-	17	121	1
60's Organ	-	17	121	2
Perc. Organ	-	18	121	1
Rock Organ	-	19	121	0
Church Organ 2	-	20	121	1
Church Organ 3	-	20	121	2
Reed Organ	-	21	121	0
Puff Organ	-	21	121	1
FrenchAccordion	-	22	121	0
Accordion	-	22	121	1
Harmonica	-	23	121	0
Tango Accordion	-	24	121	0
Nylon Acoustic	-	25	121	0
Ukulele	-	25	121	1
Nylon Acoustic2	-	25	121	2

Sound Name	Multi-timbral mode = off/on1		Multi-timbral mode = on2	
	Program Number	Program Number	Bank	
			MSB	LSB
Nylon Acoustic3	-	25	121	3
Steel Guitar	-	26	121	0
12 String	-	26	121	1
Mandolin	-	26	121	2
Steel Guitar 2	-	26	121	3
Jazz Guitar	-	27	121	0
Pedal Steel	-	27	121	1
Electric Guitar	-	28	121	0
E. Guitar 2	-	28	121	1
Rhythm Guitar	-	28	121	2
Muted Electric	-	29	121	0
Cutting Guitar2	-	29	121	1
E. Guitar 3	-	29	121	2
Country Lead	-	29	121	3
OverdriveGuitar	-	30	121	0
Dynmic Ov.drive	-	30	121	1
Distortion	-	31	121	0
Dist Feedback	-	31	121	1
Dist Rhythm	-	31	121	2
E.Gtr Harmonics	-	32	121	0
Guitar Feedback	-	32	121	1
FingerSlap Bass	-	34	121	1
Pick Bass	-	35	121	0
Slap Bass	-	37	121	0
Slap Bass 2	-	38	121	0
Synth Bass	-	39	121	0
Warm Synth Bass	-	39	121	1
Synth Bass 3	-	39	121	2
Clavi Bass	-	39	121	3
Hammer Bass	-	39	121	4
Synth Bass 2	-	40	121	0
Synth Bass 4	-	40	121	1
Rubber Bass	-	40	121	2
Attack Bass	-	40	121	3
Violin	-	41	121	0
Slow Violin	-	41	121	1
Viola	-	42	121	0
Cello	-	43	121	0
Contrabass	-	44	121	0
Tremolo Strings	-	45	121	0
Celtic Harp	-	47	121	1
Timpani	-	48	121	0
Strings & Brass	-	49	121	1
60's Strings	-	49	121	2

Program Change Number List

Sound Name	Multi-timbral mode = off/on1		Multi-timbral mode = on2	
	Program Number	Program Number	Bank	
			MSB	LSB
StringEnsemble2	-	50	121	0
Synth Strings	-	51	121	0
Synth Strings 3	-	51	121	1
Synth Strings 2	-	52	121	0
Choir 3	-	53	121	1
Voice Oohs	-	54	121	0
Humming	-	54	121	1
Synth Vocal	-	55	121	0
Analog Voice	-	55	121	1
Orchestra Hit	-	56	121	0
Bass Hit Plus	-	56	121	1
6th Hit	-	56	121	2
Euro Hit	-	56	121	3
Trumpet	-	57	121	0
Solo Trumpet	-	57	121	1
Trombone	-	58	121	0
Trombone 2	-	58	121	1
Bright Trombone	-	58	121	2
Tuba	-	59	121	0
Muted Trumpet	-	60	121	0
Muted Trumpet 2	-	60	121	1
French Horns	-	61	121	0
Warm FrenchHorn	-	61	121	1
Brass Section	-	62	121	0
Brass Section 2	-	62	121	1
Synth Brass	-	63	121	0
Synth Brass 3	-	63	121	1
Analog Brass	-	63	121	2
Jump Brass	-	63	121	3
Synth Brass 2	-	64	121	0
Synth Brass 4	-	64	121	1
Analog Brass 2	-	64	121	2
Soprano Sax	-	65	121	0
Alto Sax	-	66	121	0
Tenor Sax	-	67	121	0
Baritone Sax	-	68	121	0
Oboe	-	69	121	0
English Horn	-	70	121	0
Bassoon	-	71	121	0
Clarinet	-	72	121	0
Piccolo	-	73	121	0
Flute	-	74	121	0
Recorder	-	75	121	0
Pan Flute	-	76	121	0

Sound Name	Multi-timbral mode = off/on1		Multi-timbral mode = on2	
	Program Number	Program Number	Bank	
			MSB	LSB
Blown Bottle	-	77	121	0
Shakuhachi	-	78	121	0
Whistle	-	79	121	0
Ocarina	-	80	121	0
Square	-	81	121	0
Square 2	-	81	121	1
Sine	-	81	121	2
Classic Synth	-	82	121	0
Classic Synth 2	-	82	121	1
Lead	-	82	121	2
Classic Synth 3	-	82	121	3
SequencedAnalog	-	82	121	4
Caliope	-	83	121	0
Chiff	-	84	121	0
Charang	-	85	121	0
Wire Lead	-	85	121	1
Voice	-	86	121	0
Fifth	-	87	121	0
Bass & Lead	-	88	121	0
Soft Wire Lead	-	88	121	1
Warm Pad	-	90	121	0
Sine Pad	-	90	121	1
Polysynth	-	91	121	0
Choir Pad	-	92	121	0
Metallic Pad	-	94	121	0
Halo Pad	-	95	121	0
Sweep Pad	-	96	121	0
Rain Pad	-	97	121	0
Soundtrack	-	98	121	0
Crystal	-	99	121	0
Synth Mallet	-	99	121	1
Brightness	-	101	121	0
Goblin	-	102	121	0
Echoes	-	103	121	0
Echo Bell	-	103	121	1
Echo Pan	-	103	121	2
Sci-Fi	-	104	121	0
Sitar	-	105	121	0
Sitar 2	-	105	121	1
Banjo	-	106	121	0
Shamisen	-	107	121	0
Koto	-	108	121	0
Taisho Koto	-	108	121	1
Kalimba	-	109	121	0

Program Change Number List

Sound Name	Multi-timbral mode = off/on1		Multi-timbral mode = on2	
	Program Number	Program Number	Bank	
			MSB	LSB
Bag Pipe	-	110	121	0
Fiddle	-	111	121	0
Shanai	-	112	121	0
Tinkle Bell	-	113	121	0
Agogo	-	114	121	0
Steel Drums	-	115	121	0
Woodblock	-	116	121	0
Castanet	-	116	121	1
Taiko Drums	-	117	121	0
Concert BD	-	117	121	1
Melodic Toms	-	118	121	0
Melodic Toms 2	-	118	121	1
Synth Drum	-	119	121	0
Rhythm Box Tom	-	119	121	1
Electric Drum	-	119	121	2
Reverse Cymbal	-	120	121	0
Gtr Fret Noise	-	121	121	0
GtrCuttingNoise	-	121	121	1
Ac Bass Slap	-	121	121	2
Breath Noise	-	122	121	0
Flute Key Click	-	122	121	1
Seashore	-	123	121	0
Rain	-	123	121	1
Thunder	-	123	121	2
Wind	-	123	121	3
Stream	-	123	121	4
Bubble	-	123	121	5
Bird Tweet	-	124	121	0
Dog Barking	-	124	121	1
Horse Gallop	-	124	121	2
Bird Tweet 2	-	124	121	3
Telephone	-	125	121	0
Telephone 2	-	125	121	1
Door Creak	-	125	121	2
Door Slam	-	125	121	3
Scratch	-	125	121	4
Wind Chime	-	125	121	5
Helicopter	-	126	121	0
Car Engine	-	126	121	1
Car Stopping	-	126	121	2
Car Passing	-	126	121	3
Car Crash	-	126	121	4
Siren	-	126	121	5
Train	-	126	121	6

Sound Name	Multi-timbral mode = off/on1		Multi-timbral mode = on2	
	Program Number	Program Number	Bank	
			MSB	LSB
Jet Plane	-	126	121	7
Starship	-	126	121	8
Burst Noise	-	126	121	9
Applause	-	127	121	0
Laughing	-	127	121	1
Screaming	-	127	121	2
Punch	-	127	121	3
Heartbeat	-	127	121	4
Foot Step	-	127	121	5
Gunshot	-	128	121	0
Machine Gun	-	128	121	1
Laser Gun	-	128	121	2
Explosion	-	128	121	3
Pop Set	-	1	120	0
Ballad Set	-	9	120	0
Power Set	-	17	120	0
Electronic Set	-	25	120	0
Analog Set	-	26	120	0
Jazz Set	-	33	120	0
Brush Set	-	41	120	0
Orchestra Set	-	49	120	0
SFX Set	-	57	120	0

Drum Rhythm List

No.	Rhythm Name
8 Beat	
1	8 Beat 1
2	8 Beat 2
3	8 Beat 3
4	Pop 1
5	Pop 2
6	Pop 3
7	Pop 4
8	Pop 5
9	Pop 6
10	Ride Beat 1
11	Ride Beat 2
12	Dance Pop 1
13	Country Pop
14	Smooth Beat
15	Rim Beat
8 Beat Rock	
16	Modern Rock 1
17	Modern Rock 2
18	Modern Rock 3
19	Modern Rock 4
20	Pop Rock
21	Ride Rock
22	Jazz Rock
23	Surf Rock
16 Beat	
24	16 Beat
25	Indie Pop 1
26	Acid Jazz 1
27	Ride Beat 3
28	Dance Pop 2
29	Dance Pop 3
30	Dance Pop 4
31	Dance Pop 5
32	Dance Pop 6
33	Dance Pop 7
34	Dance Pop 8
35	Indie Pop 2
36	Cajun Rock
8 Beat Ballad	
37	Pop Ballad 1
38	Pop Ballad 2
39	Pop Ballad 3
40	Rock Ballad 1
41	Rock Ballad 2
42	Slow Jam
43	6/8 R&B Ballad
44	Triplet Ballad 1
45	Triplet Ballad 2
16 Beat Ballad	
46	16 Ballad 1
47	Dance Ballad 1
48	Dance Ballad 2
49	Dance Ballad 3
50	Electro Pop
51	16 Ballad 2
52	Mod Pop Ballad

No.	Rhythm Name
16 Beat Dance	
53	Dance 1
54	Dance 2
55	Dance 3
56	Disco
57	Techno 1
58	Techno 2
16 Beat Swing	
59	16 Shuffle 1
60	16 Shuffle 2
61	16 Shuffle 3
62	Acid Jazz 2
63	Acid Jazz 3
64	New Jack Swing
65	Modern Dance
66	Indie Pop 3
8 Beat Swing	
67	Swing Beat
68	Motown
69	Country 2 Beat
70	Boogie
Triplet	
71	8 Shuffle 1
72	8 Shuffle 2
73	8 Shuffle 3
74	Dance Shuffle
75	Triplet 1
76	Triplet 2
77	Triplet Rock
78	Reggae
Jazz	
79	H.H. Swing
80	Ride Swing
81	Fast 4 Beat
82	Afro Cuban
83	Jazz Bossa
84	Jazz Waltz
85	5/4 Swing
Latin / Traditional	
86	H.H. Bossa Nova
87	Ride Bossa Nova
88	Beguine
89	Rhumba
90	Cha Cha
91	Mambo
92	Samba
93	Sala
94	Merenge
95	Tango
96	Habanera
97	Waltz
98	Ragtime
99	March
100	6/8 March

Specifications

Keyboard		Millennium III Hybrid action with 88-key graded ABS hammers and damper mechanism Integrated Hammer Sensing System (IHSS), contact-less optical sensors
Sound Source	Pianist mode	SK-EX Rendering: 88-key multi-channel piano sampling, 88-key resonance modelling
	Sound mode	Harmonic Imaging XL: 88-key piano sampling
Internal Sounds	Pianist mode	SK-EX Concert Grand, 10 rendering characters
	Sound mode	88 sounds
Keyboard Modes		Dual, Split, 4Hands (Volume/Balance adjustable)
Polyphony		max. 256 notes (depending on selected sound)
Effects	Pianist mode	Resonance Depth (10 types), Ambience (10 types)
	Sound mode	Reverb (6 types), Effects (24 types) (Chorus x 3, Delay x 3, Tremolo x 3, Auto pan x 2, Phaser x 2, Rotary x 6, Combination x 5)
Virtual Technician	Pianist mode	Touch Curve (incl. User), Voicing (incl. User), Damper Noise, Fall-back Noise, Hammer Delay, Minimum Touch, Key Volume (incl. User), Half-Pedal Adjust, Soft Pedal Depth
	Sound mode	Touch Curve (incl. User), Voicing (incl. User), Damper Resonance, Damper Noise, String Resonance, Undamped String Resonance, Cabinet Resonance, Key-off Effect, Fall-back Noise, Hammer Delay, Topboard Simulation, Decay Time, Minimum Touch, Stretch Tuning (incl. User), Temperament (incl. User), Temperament Key, Key Volume (incl. User), Half-Pedal Adjust, Soft Pedal Depth
Internal Recorder	Pianist mode	3 song recorder (approximately 10 min. per song)
	Sound mode	10 song, 2 track recorder (approximately 90,000 note memory capacity)
USB Recorder	Playback	MP3, WAV, SMF, KSO (internal song file)
	Record	MP3, WAV, Overdub audio, Save as SMF/KSO, Line In Recording
Metronome		1/4, 2/4, 3/4, 4/4, 5/4, 3/8, 6/8, 7/8, 9/8, 12/8 + 100 drum rhythms 10~400 bpm (20~800 bpm for eighth note rhythms)
Internal Songs	Demo Songs	39 songs
	Piano Music	29 or 42 songs ¹
	Concert Magic	176 songs
	Lesson Books	584 Songs from Alfred, Burgmüller, Czerny, Beyer, Bach, and Chopin lesson books ² , 140 Finger Exercises
Favorites		16 memories (4 x 4 pages)
Transpose		Key Transpose: -12~+12 semi-tones, Song Transpose: -12~+12 semi-tones
Other Settings & Functions	Sound Settings	Tuning (Sound mode only), Damper Hold (Sound mode only), Tone Control (incl. User), Speaker Volume, Line In Level, Wall EQ, SHS Mode, Phones Type, Phones Volume, LCD contrast, factory reset, MIDI setting, Bluetooth setting
	System Settings	Bluetooth MIDI, Bluetooth Audio, Bluetooth Audio Volume, Rename File, Delete File, USB Format, MIDI Channel, Send PGM, Local Control, Transmit PGM# On/Off, Multi-timbral Mode, Channel Mute, LCD Contrast, Auto Display Off, Auto Power Off, Factory Reset
Display		5" LCD touchscreen (480 x 800 pixels)
Bluetooth		Bluetooth (Ver. 4.0; GATT compatible) Bluetooth Low Energy MIDI Specification compliant, Bluetooth Audio
Jacks		LINE IN (1/8" STEREO), LINE IN Level, LINE OUT (1/4" L/MONO, R), Headphones x 2 (1/4", 1/8"), MIDI (IN/OUT), USB to Host, USB to Device
Pedals		Damper (with half-pedal support), Soft, Sostenuato. Grand Feel Pedal System
Speaker System	Speakers	10 cm x 4 (top speakers) 1.4 cm x 2 (dome tweeters) 16 cm x 1 (woofer)
	Output Power	135 W (45 W x 3)
Power Consumption		60 W
Dimensions (Not including music rack)		1480 (W) x 645 (D) x 925 (H) mm 58 1/3" (W) x 25 1/2" (D) x 36 1/2" (H)
Weight		127.0 kg / 280 lbs.

¹ Depending on market location.

² Lesson books sold separately.

Specifications are subject to change without notice.

* Availability of Bluetooth function dependent on market location.

MIDI Exclusive Data Format

1st byte	2nd byte	3rd byte	4th byte	5th byte	6th byte	7th byte	8th byte	9th byte	10th byte
1	2	3	4	5	6	7	8	9	10

Byte	ID	Description
1	F0	Start code
2	40	Kawai ID number
3	00 - 0F	MIDI channel
4	10, 30	Function code (30 when setting Multi-timbre On/Off)
5	04	Indicates that the instrument is an electric piano
6	02	Indicates that the piano is a CA/ES model
7	data 1	See table below
8	data 2	
9	data 3	
10	F7	End code

data 1	data 2	data 3	Function
00	00	-	Multi-timbre Off
01	00	-	Multi-timbre On 1
02	00	-	Multi-timbre On 2
0F	00 - 7F	-	Split Point
14	00 - 7F	-	Dual/Split balance
16	1F - 60	-	Tune, 40: 440 Hz
17	00, 7F	-	00: Program Change Off, 7F: Program Change On
18	00 - 07	-	00: Light, 01: Normal, 02: Heavy, 03: Off, 04: Light +, 05: Heavy +, 06: User1, 07: User2
19	00 - 03	-	Lower Octave Shift
20	00 - 4F	00 - 4F	Dual, data 2: Main sound, 3: Layer sound
21	00 - 4F	00 - 4F	Split, data 2: Upper sound, data 3: Lower sound
22	00 - 4F	00 - 4F	Four Hands, data 2: Right sound, data 3: Left sound
25	00 - 08	00 - 0B	data 2: Temperament, data 3: Key
26	00, 7F	00 - 0F	Multi-timbre channel mute, data 2: 00 (mute On), 7F (mute Off), data 3: Channel

Function	Transmitted	Section	Remarks
Basic Channel	Default	1 - 16	1 - 16
	Changed	1 - 16	1 - 16
Mode	Default	Mode 3	Mode 1
	Messages	X	Mode 1, 3
	Altered	*****	
Note Number		21 - 108**	0 - 127
	True Voice	*****	0 - 127
Velocity	Note ON	0	0
	Note OFF	0	0
After Touch	Key	X	X
	Channel	X	X
Pitch Bend		X	X
Control Change	0, 32	0	0
	7	X	0
	10	X	0
	11	X	0
	64	0 (Right pedal)	0
	66	0 (Middle pedal)	0
67	0 (Left pedal)	0	
Program Change		0 0 - 127	0 0 - 127 ***
	True #	*****	0 - 127
System Exclusive		0	0
Common	Song Position	X	X
	Song Select	X	X
	Tune	X	X
System Real Time	Clock	X	X
	Commands	0	X
Others	Local ON/OFF	X	0
	All Note OFF	X	0 (123-127)
	Active Sense	X	0
	Reset	X	X
Notes			

Mode 1 : OMNI ON , POLY

Mode 2 : OMNI ON , MONO

0 : Yes

Mode 3 : OMNI OFF, POLY

Mode 4 : OMNI OFF, MONO

X : No

KAWAI

THE FUTURE OF THE PIANO

